

Слуховой анализатор

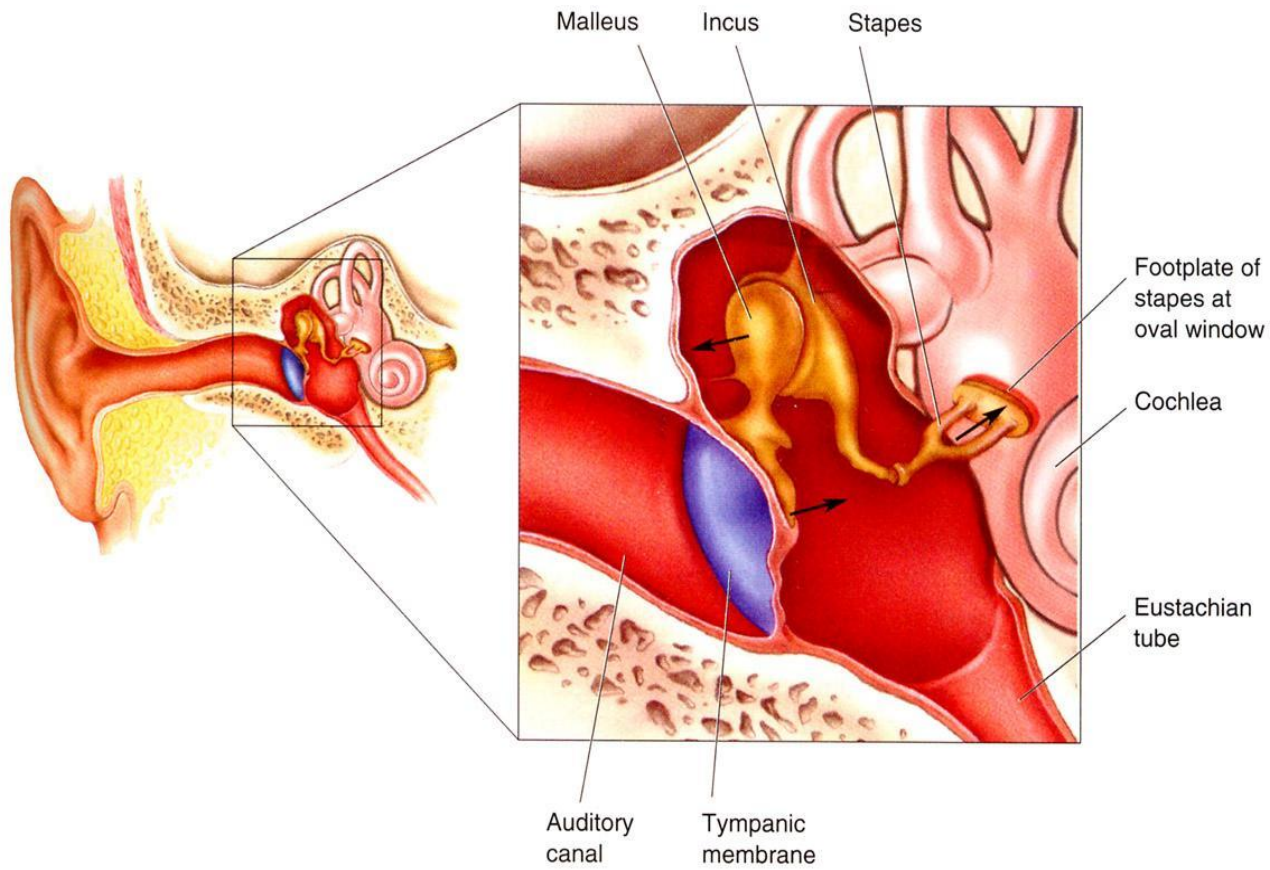

Наружное и среднее ухо



Слуховой анализатор

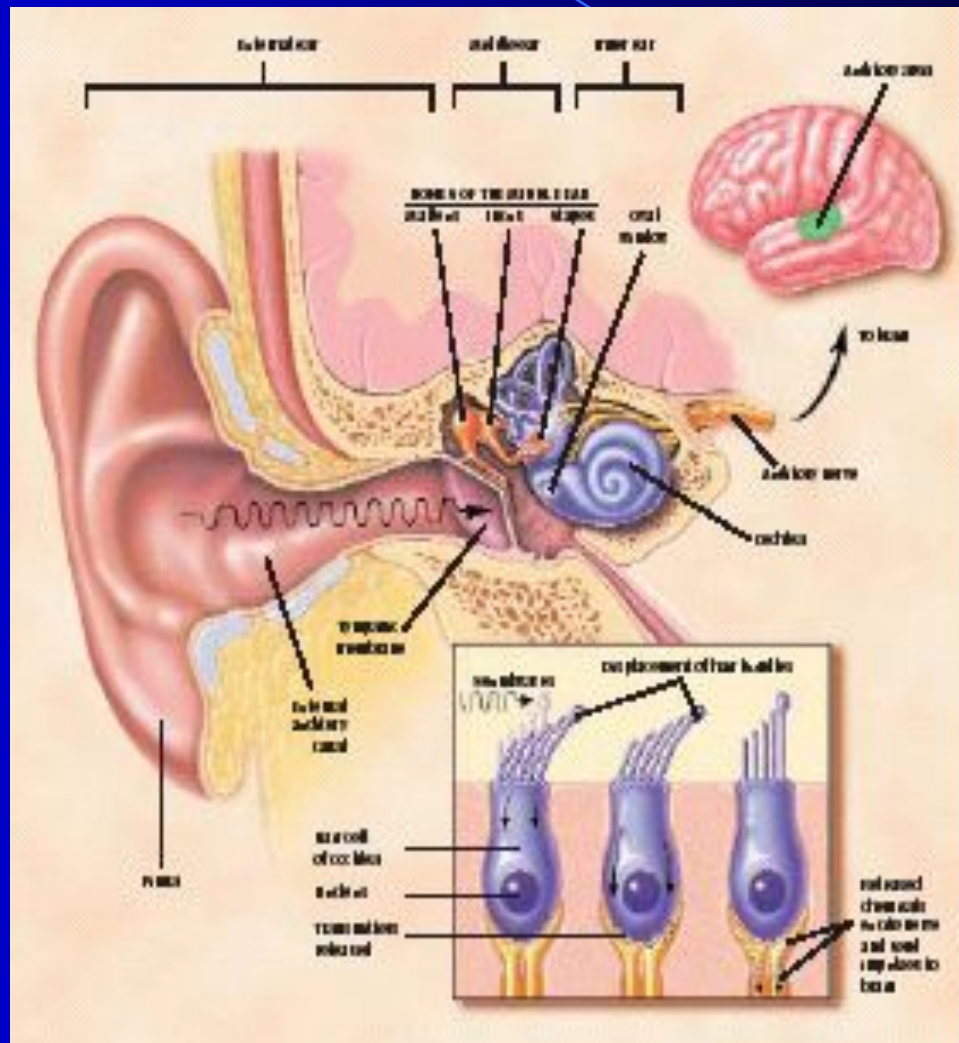

Строение уха

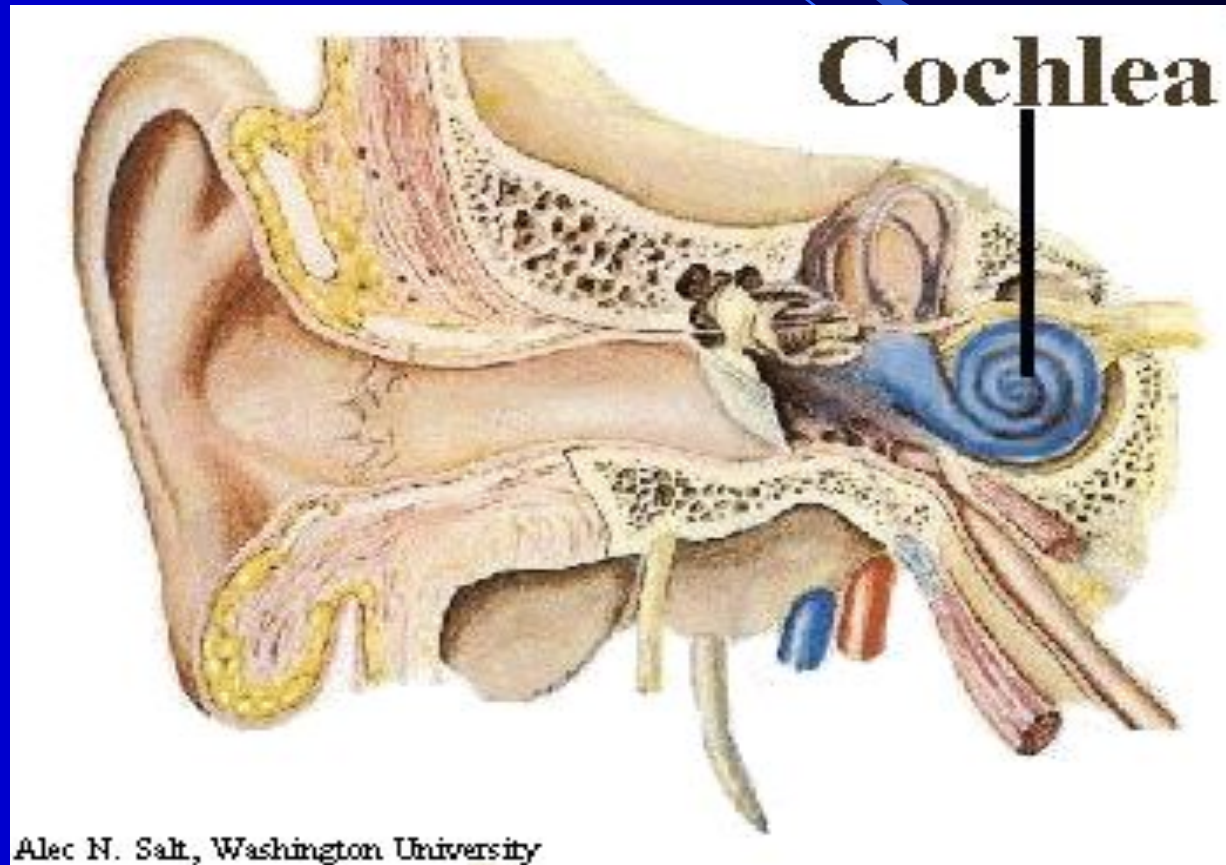

Alec N. Salt, Washington University

Схема наружного, среднего и внутреннего уха



Схема внутреннего уха



Улитка

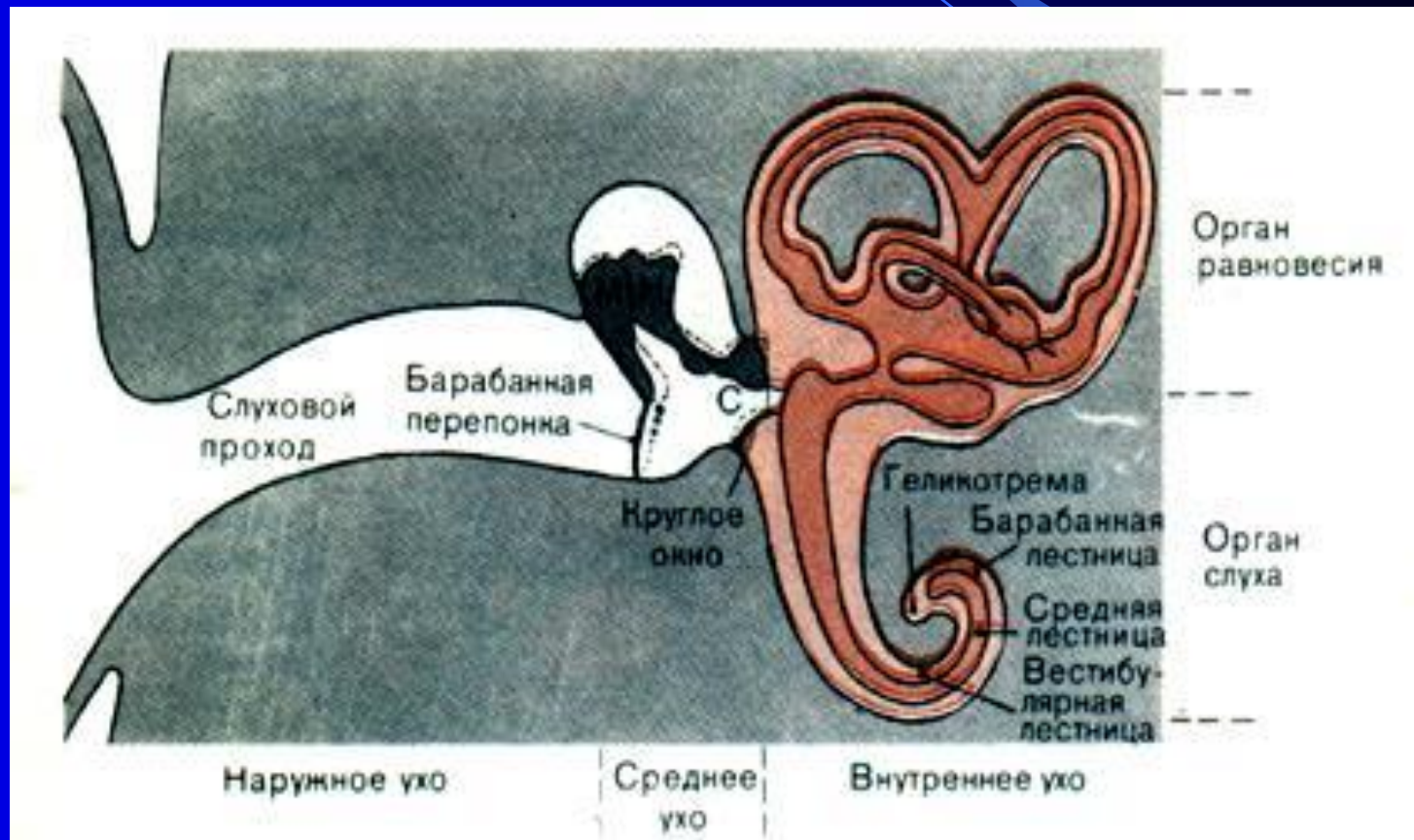
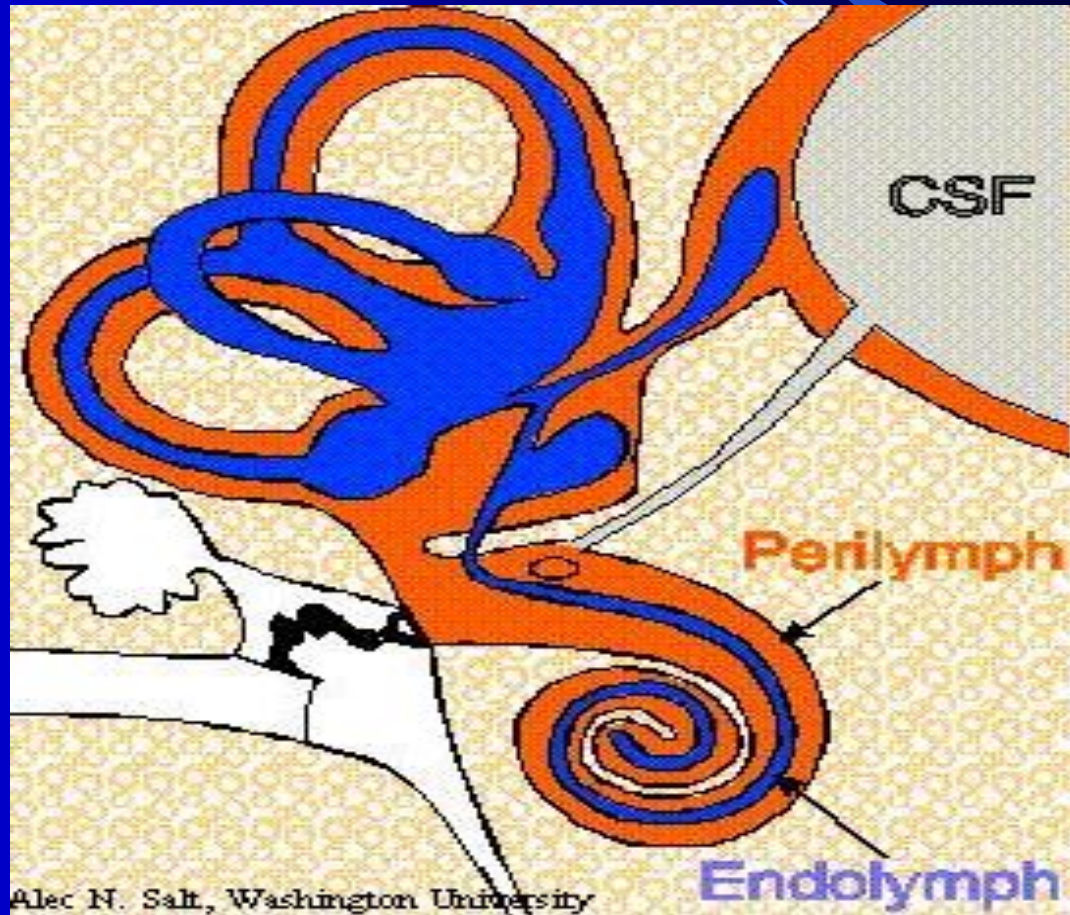

Перилимфа и эндолимфа

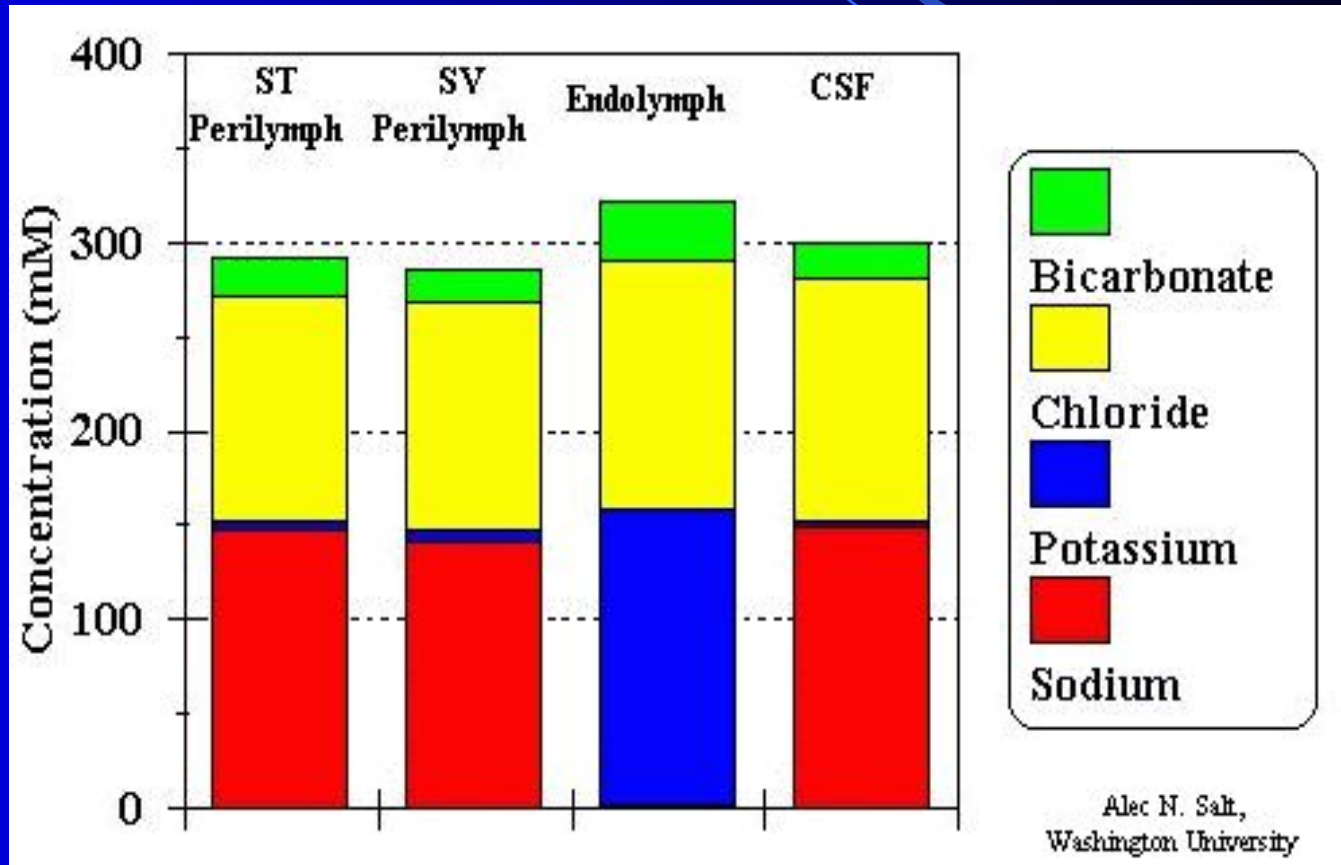

Внутреннее ухо - улитка

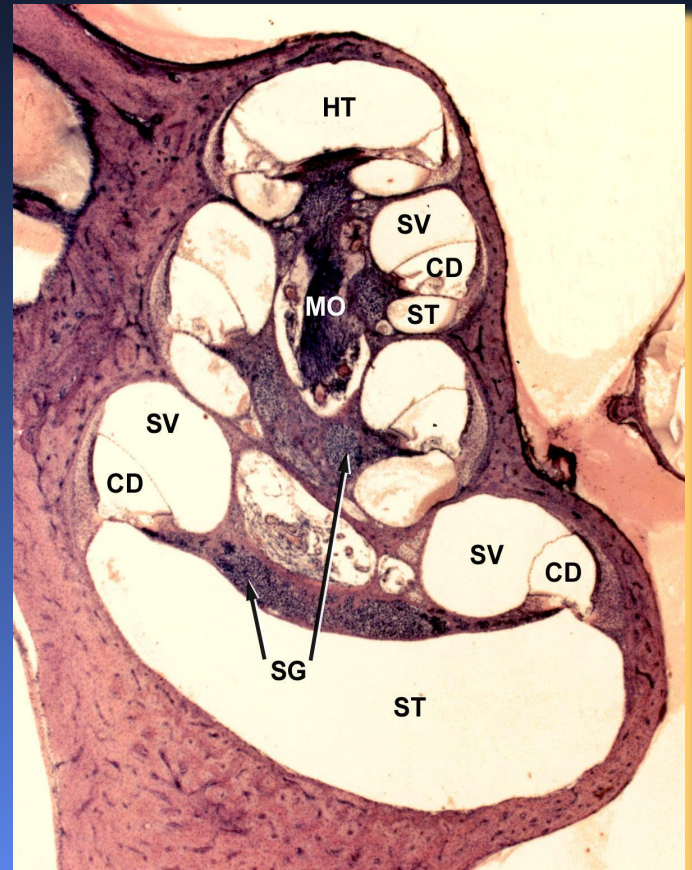
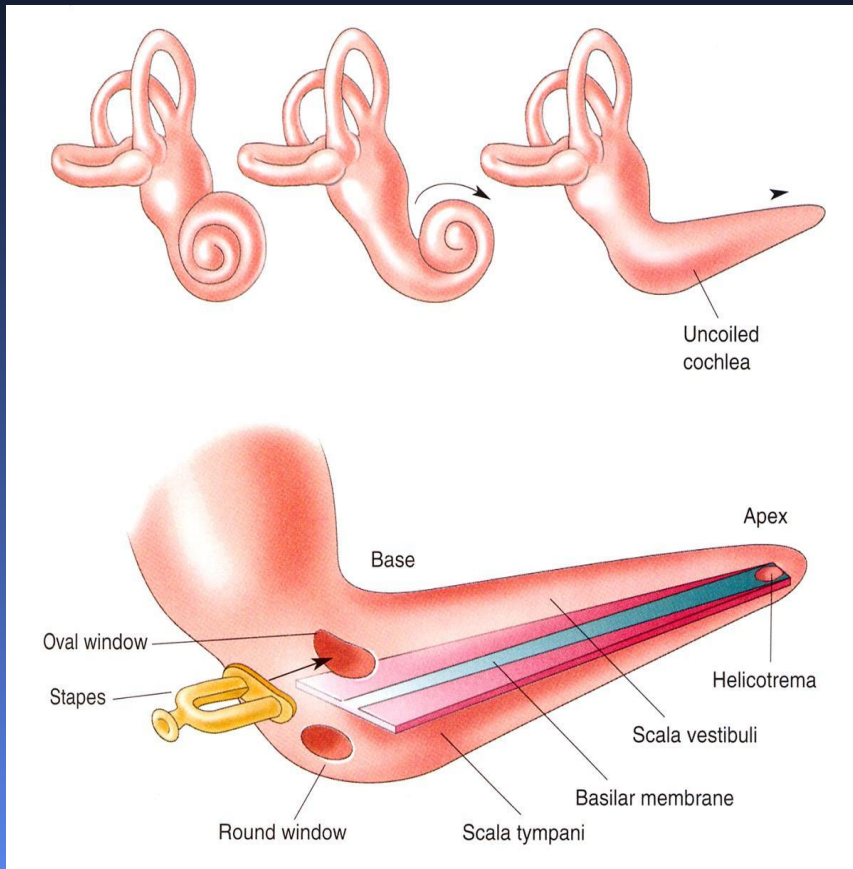

Поперечный разрез завитка улитки

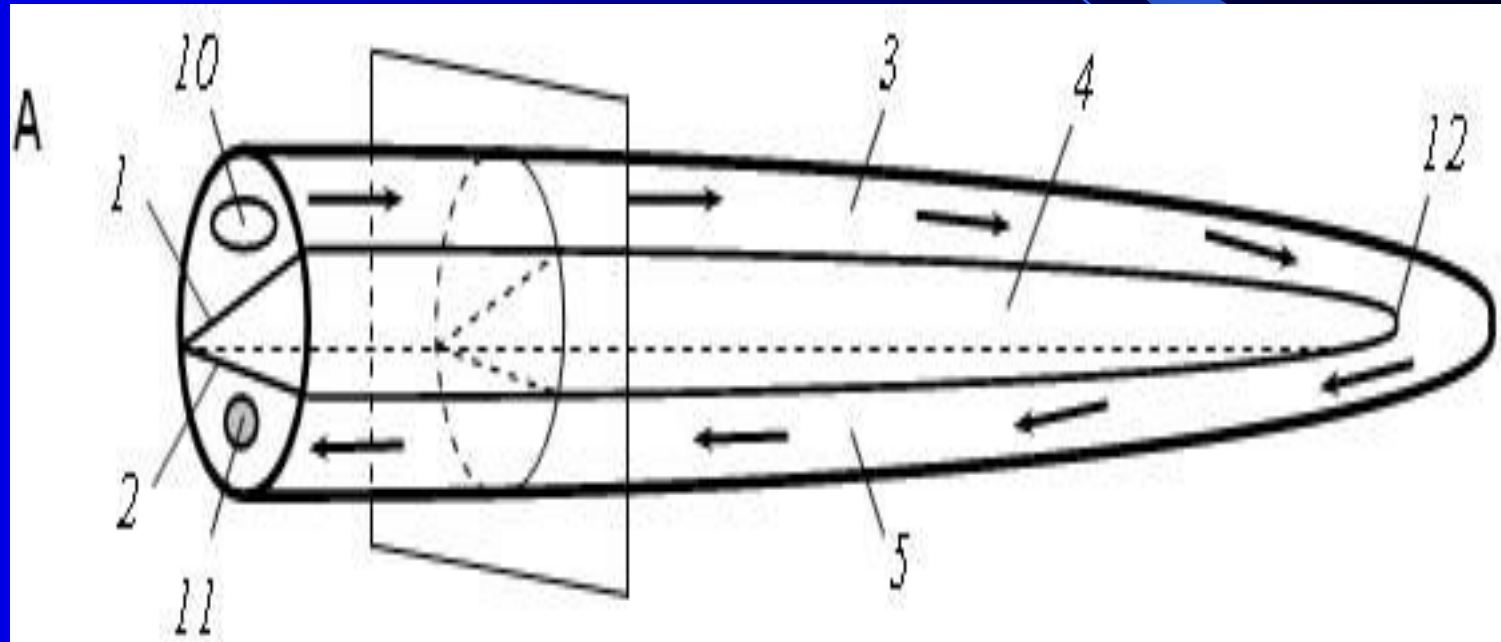

Поперечный разрез улитки

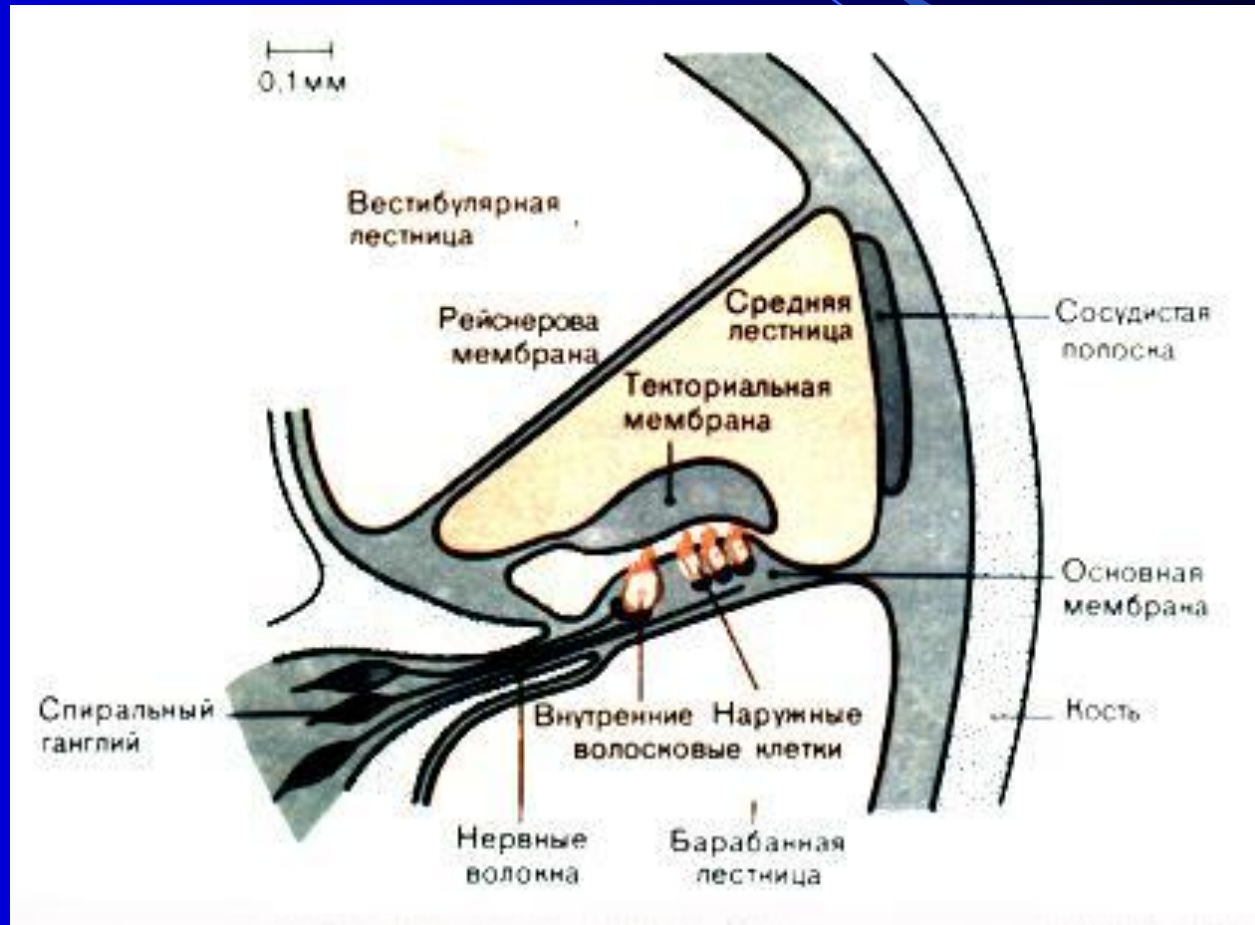

Кортиев орган –

внутренние и наружные волосковые клетки

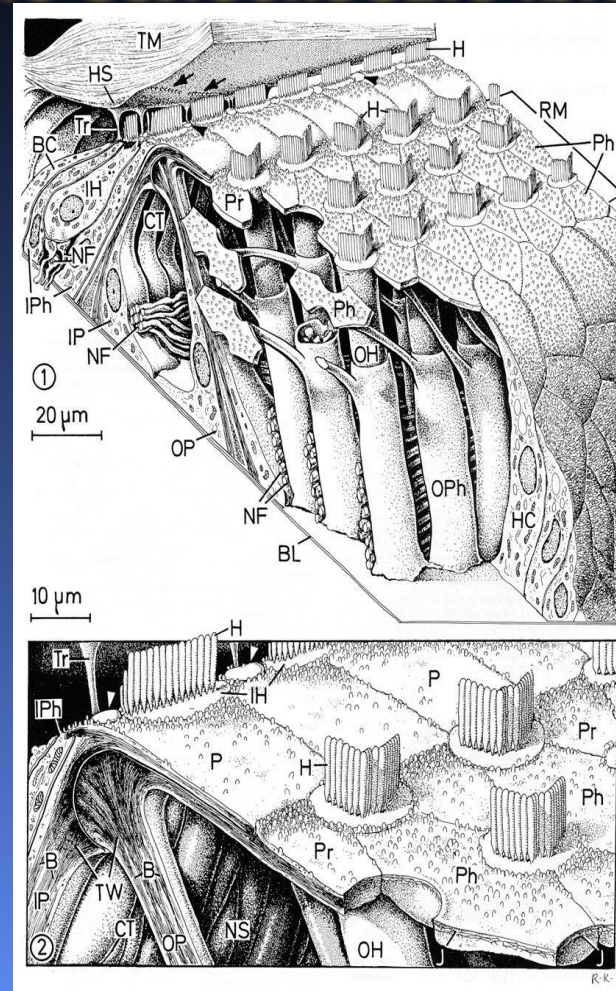
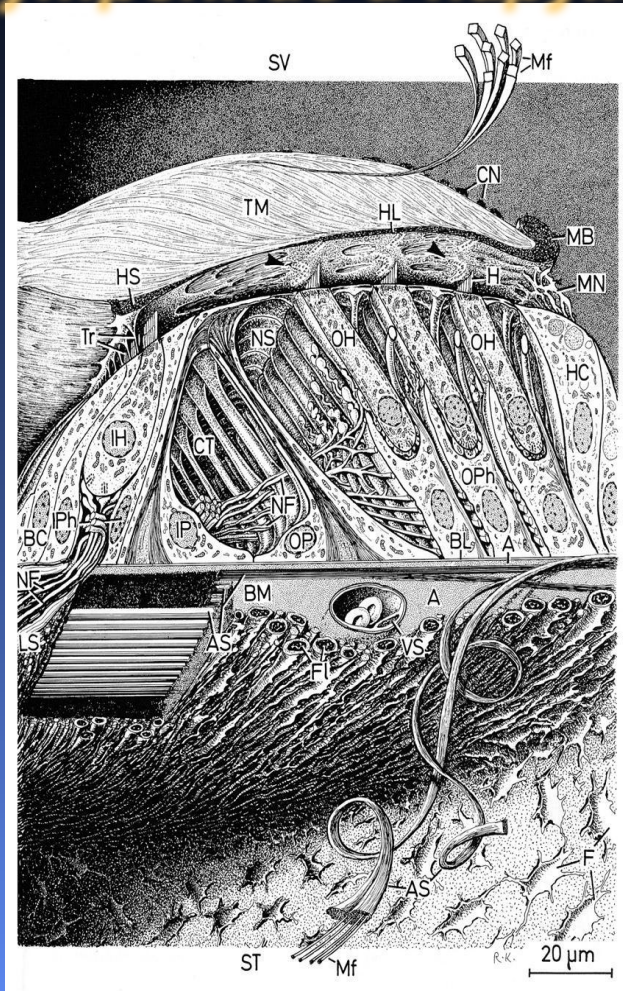

Спиральный ганглий

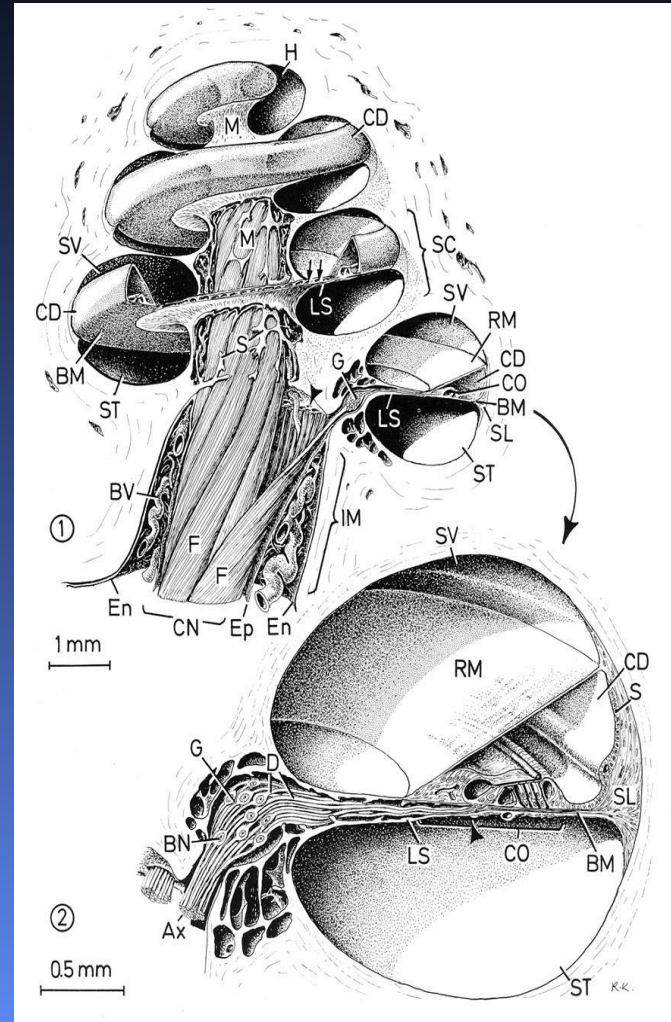
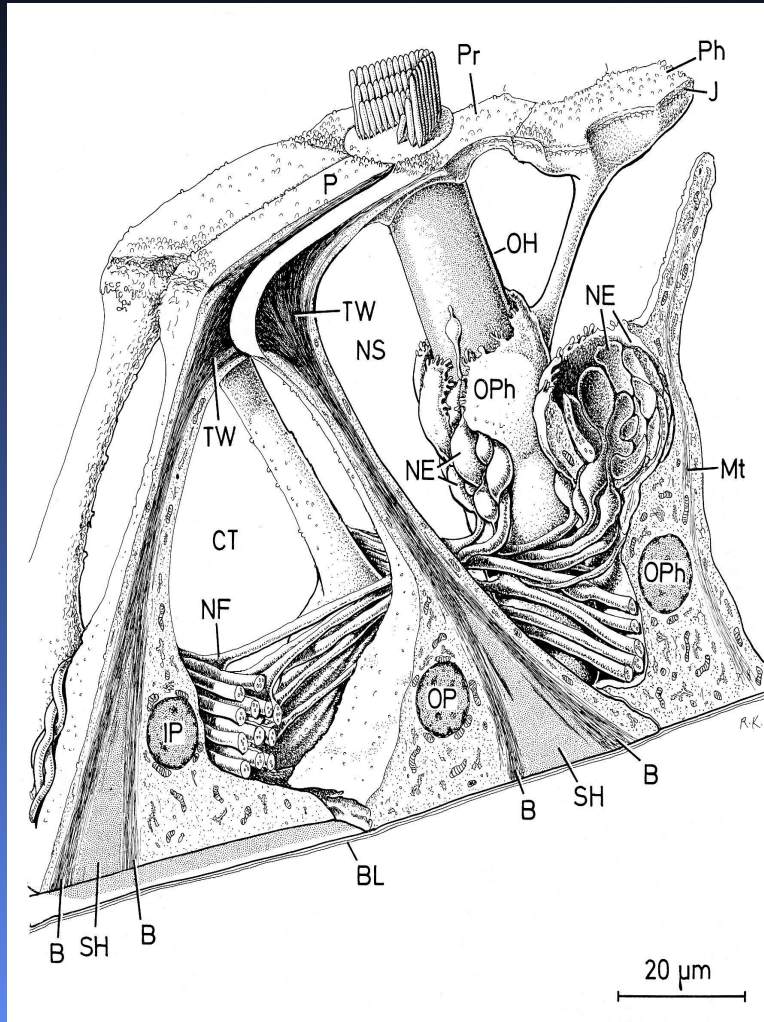

Волосковые клетки

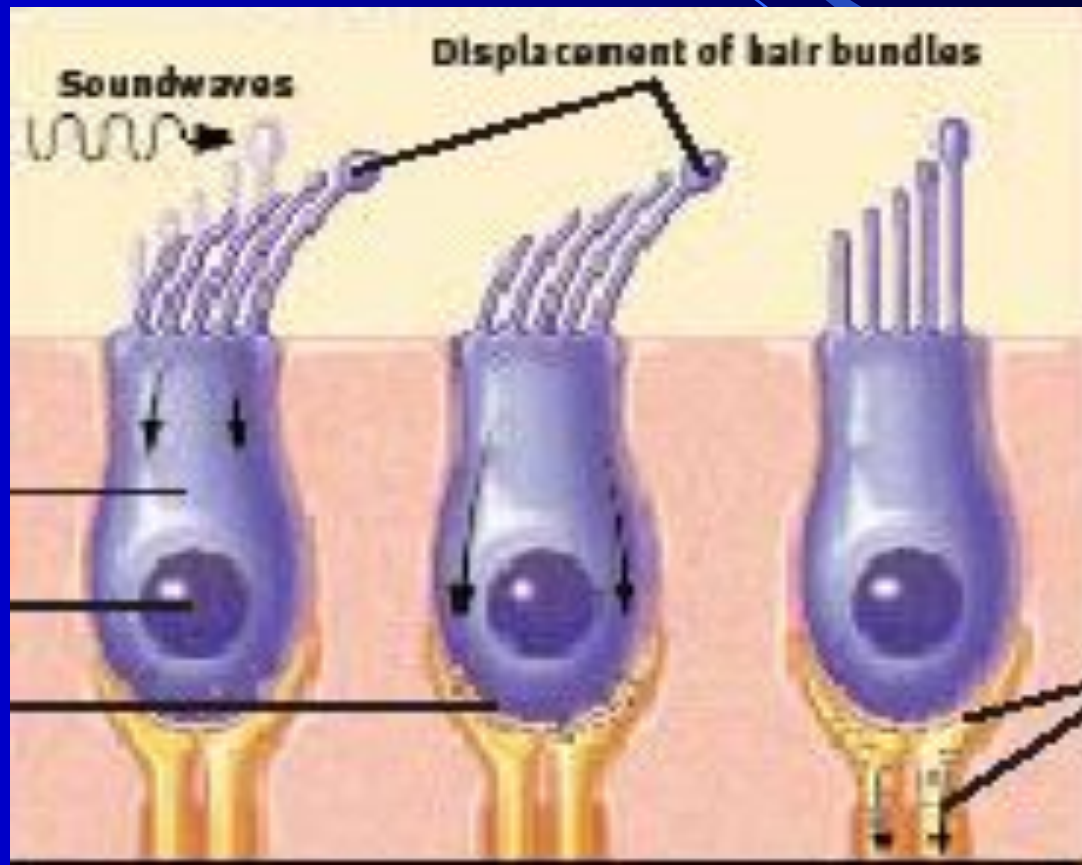

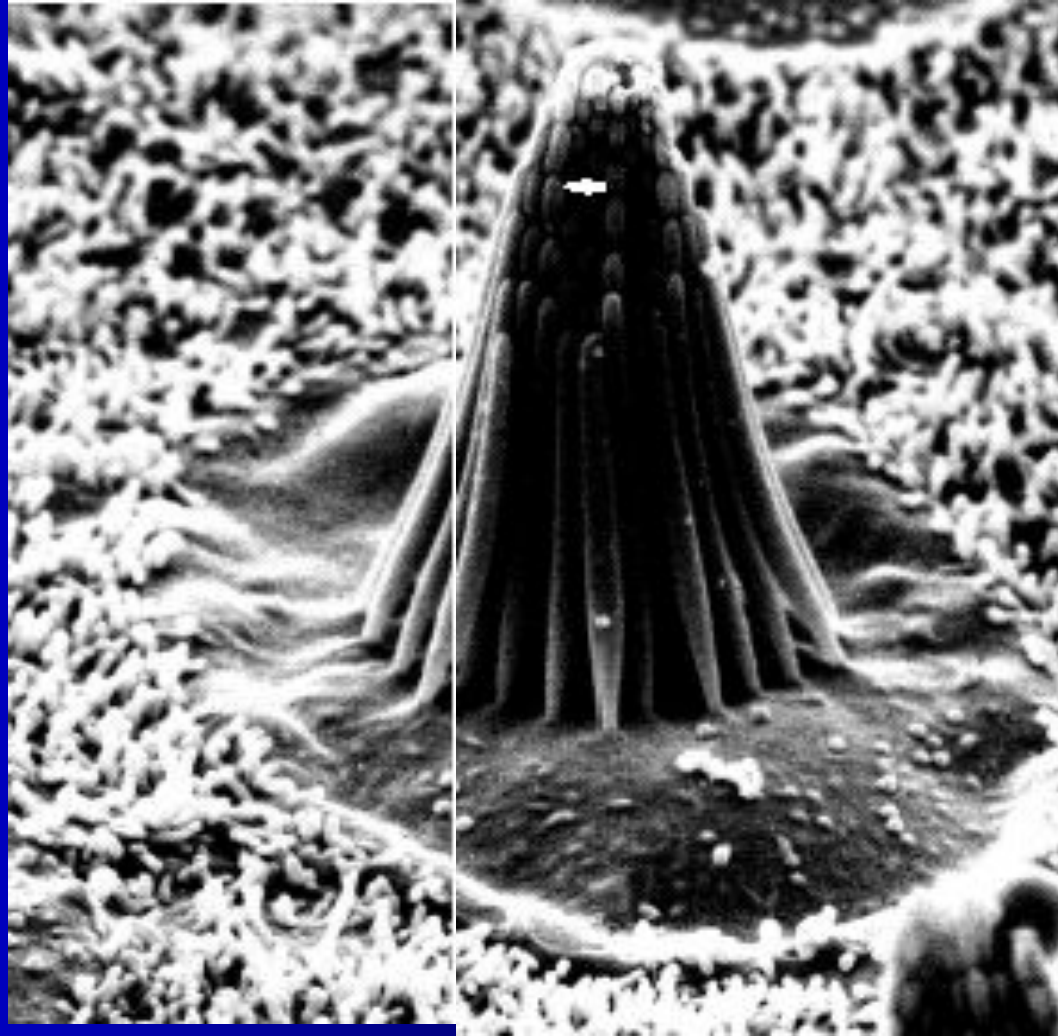

A TIP LINK PULLS UP THE GATE OF A CHANNEL.

In this sketch, James
Hilalopolski suggests how
the movement of a hair-
cell's outer bundle (top)
opens ion channels on
the tips of inner hair cells.
When
the bundle tilts to the right, tip links from
higher cells pull up the gates of ion channels
on adjoining shorter cells.

A cleavage plane has a tip link between
two cells opens an ion channel on the shorter cell.

From more highly magnified (right), the open channel allows ions
into the cell. A cluster of 23 pairs of molecules in the taller column is
shown in green and more so the filaments are shown in blue.



А

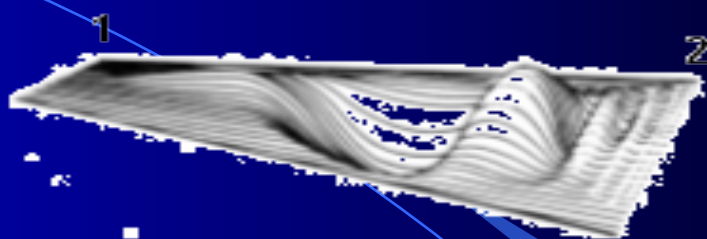

Б

Амплитуда колебаний базисной мембраны

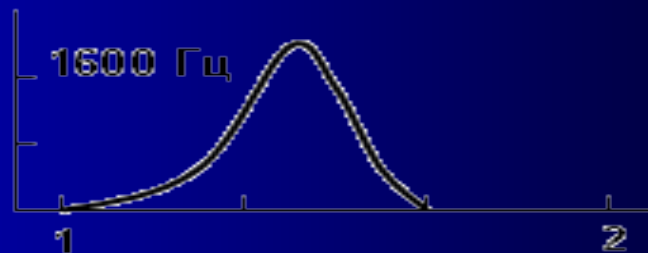
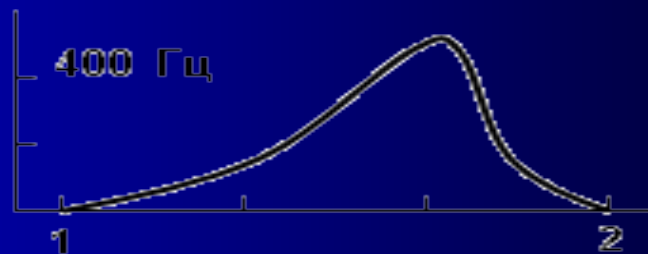
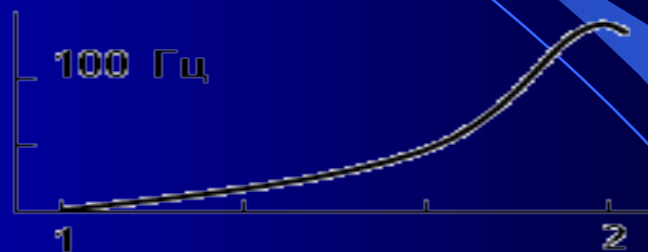

Цилии волосковой клетки кошки после 2 часов громкого звука

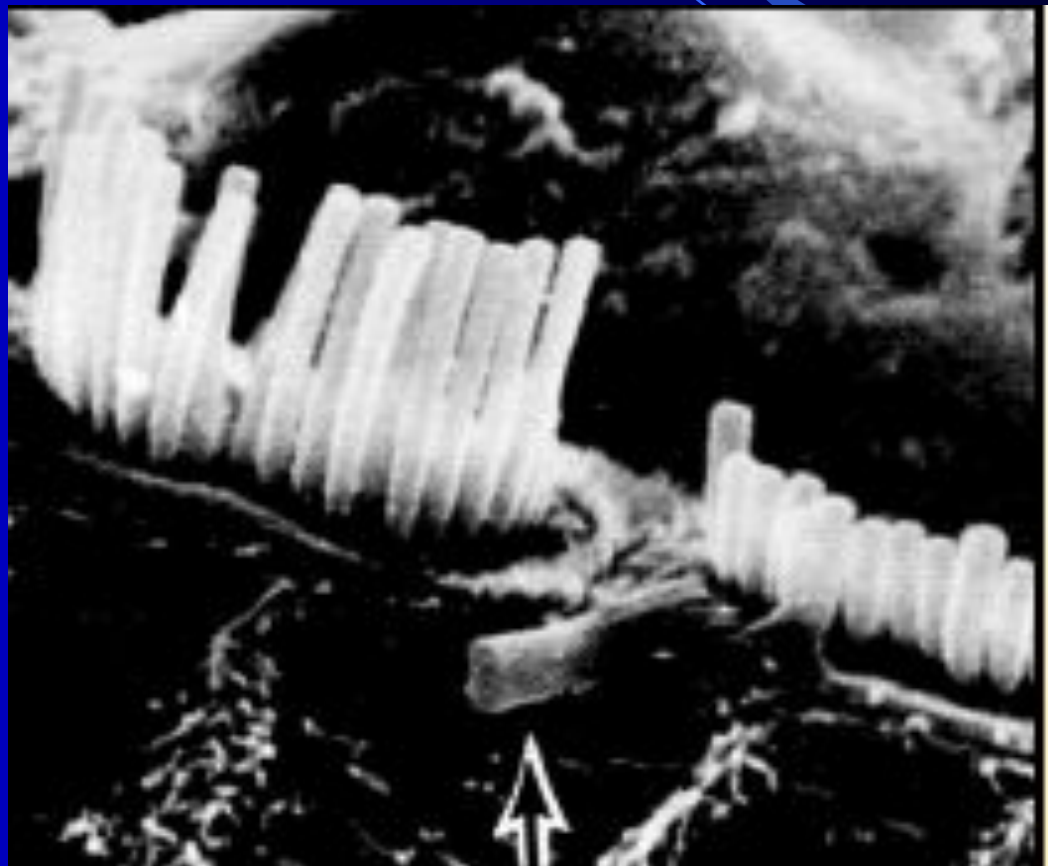

Упрощенная схема проводящих путей

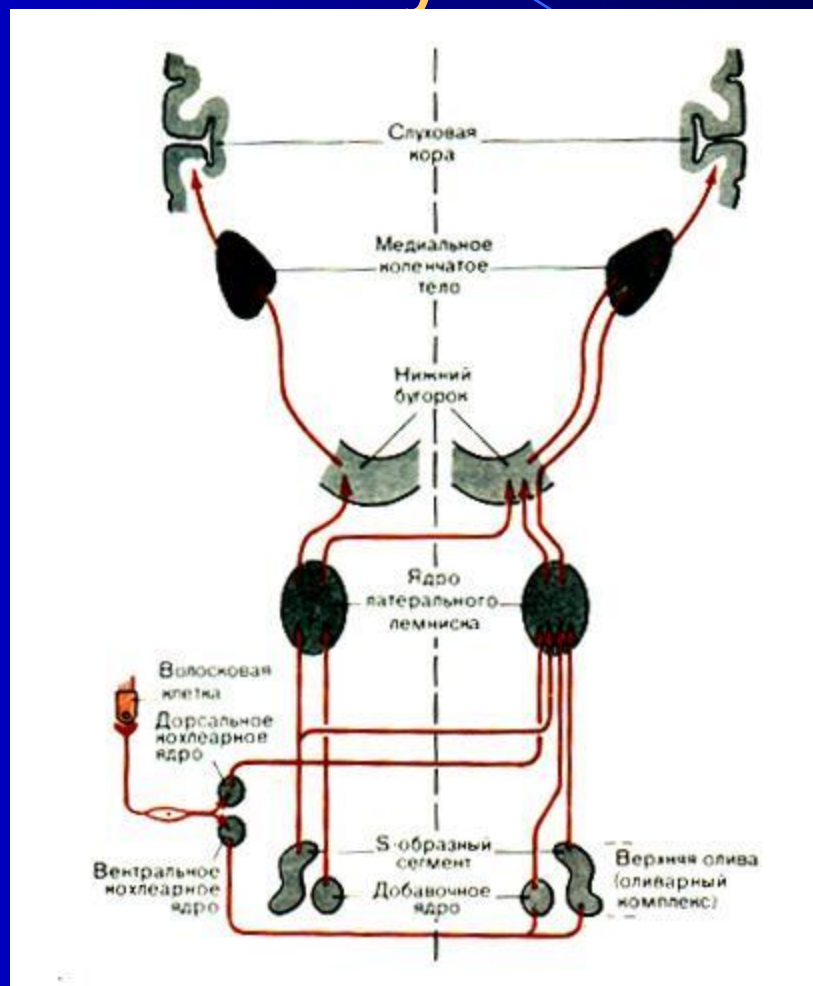

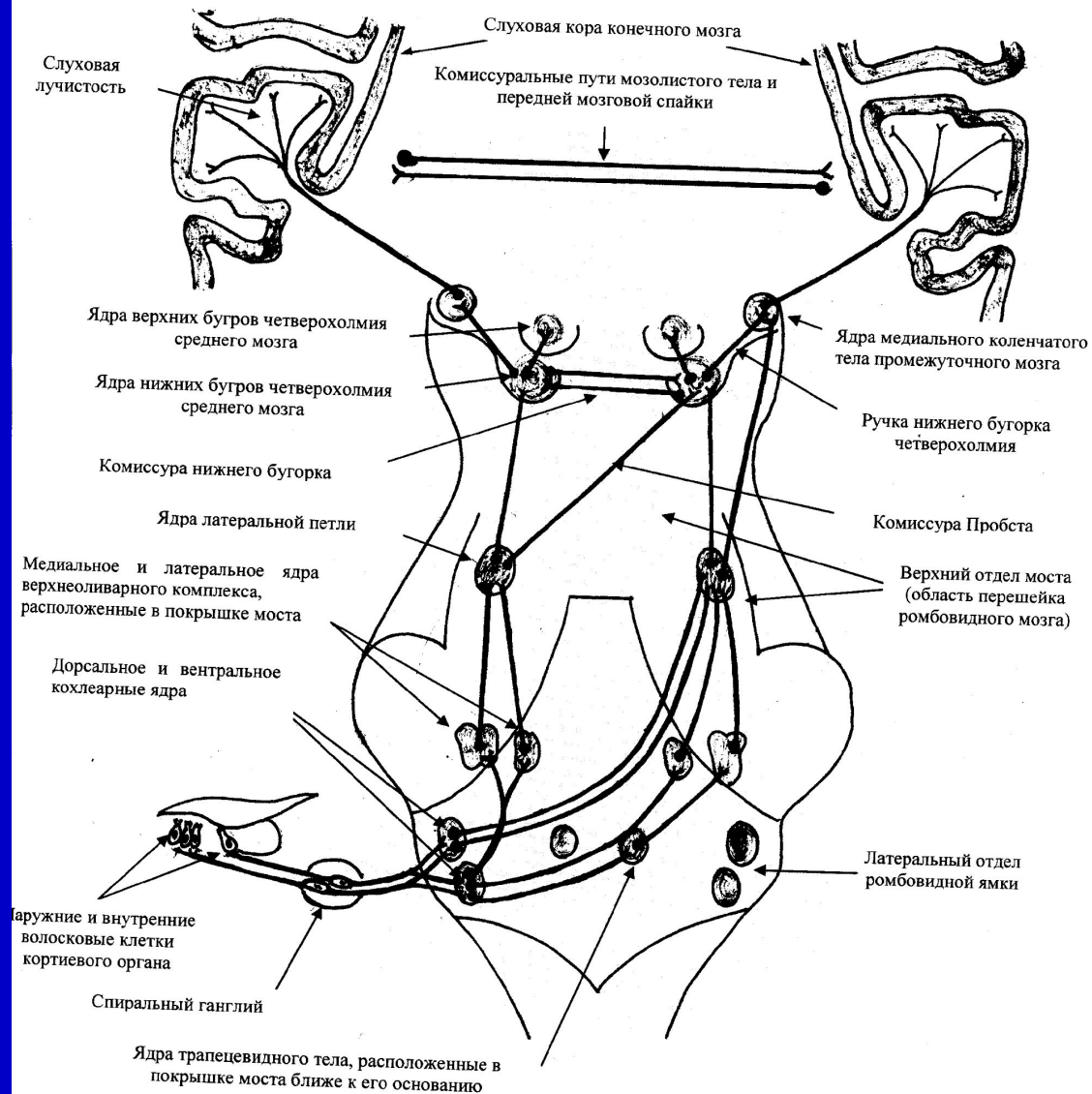

Рис. 3. Схема афферентных путей между основными структурами слуховой системы человека идущих от левого уха.