

*Решение задач
на готовых чертежах.
Четырёхугольники.*

*Геометрия.
8 класс.*

*Каратанова Марина Николаевна
МОУ СОШ №256 г.Фокино*



1

2

3

4

5

6

7

8

9

10

11

12

13

14

15

16

17

18

19

20

21

22

23

24

25

26

27

28

29

30

31

32

33

34

35

36

1.

Дано:

$AB \parallel CD; BC \parallel AD$

Доказать:

$BC = AD; \angle A = \angle C$

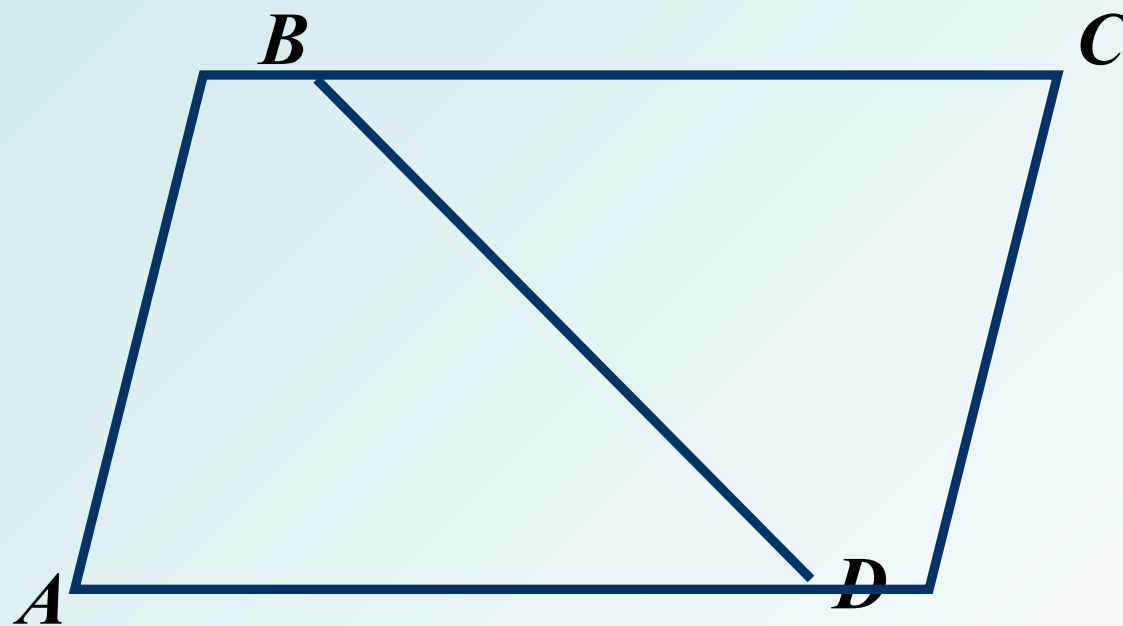

2.

Дано: $AB \parallel CD$; $AB = CD$

Доказать: O – середина AC и BD

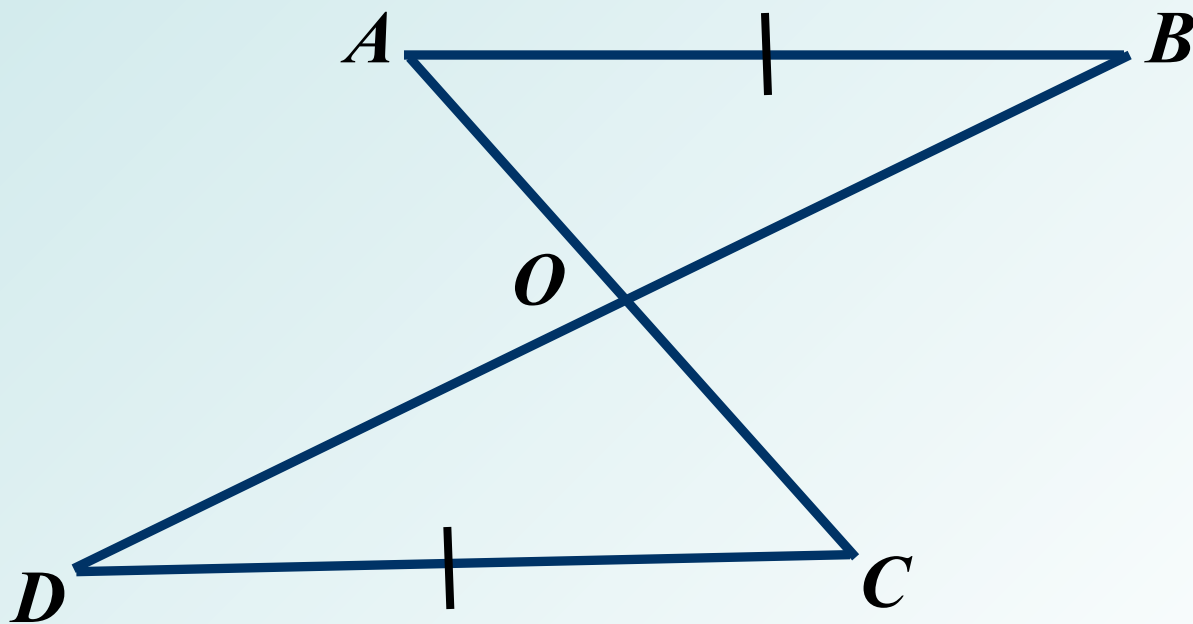

3.

Дано:

$$\angle 1 = \angle 2, \quad \angle 3 = \angle 4$$

Доказать:

$ABCD$ – параллелограмм

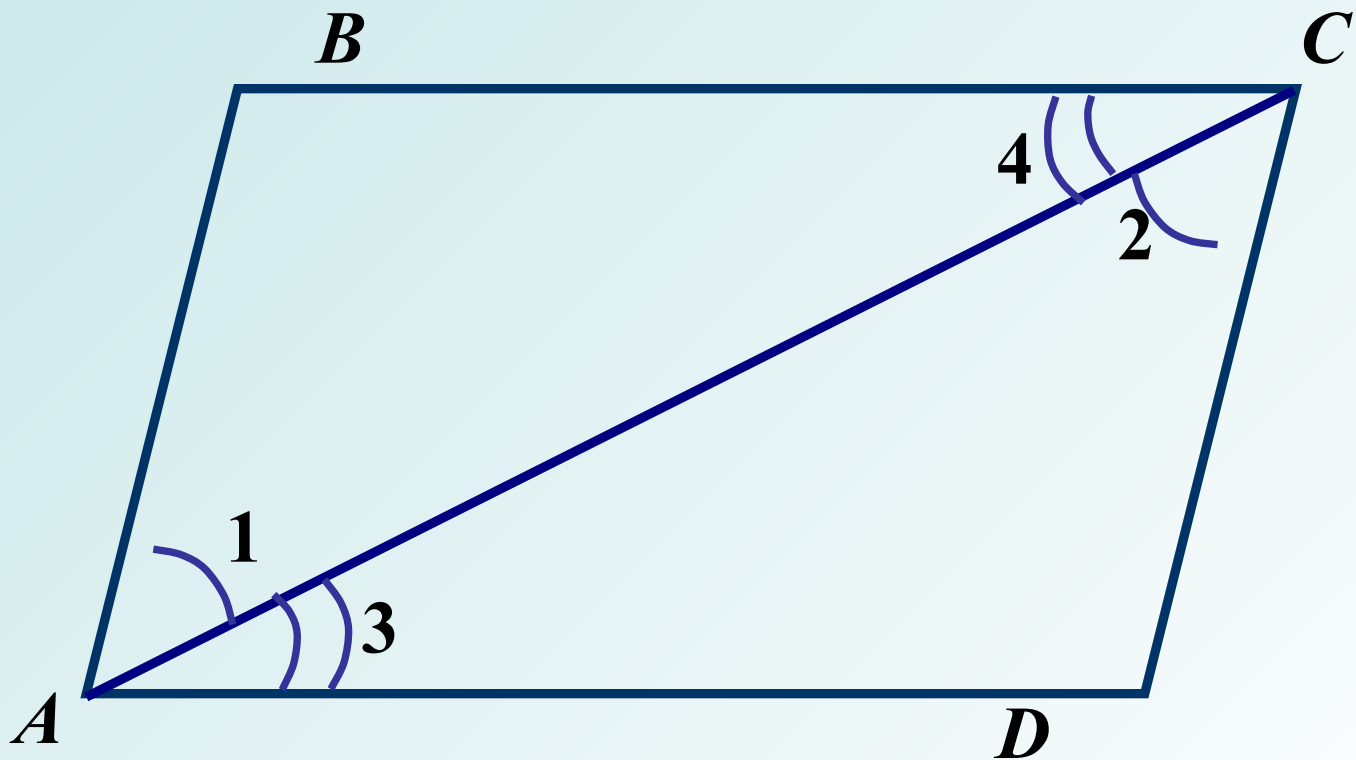

4.

Дано:

$MNPQ$, $\angle M = \angle P$

Доказать:

$MNPQ$ – *прямоугольник*

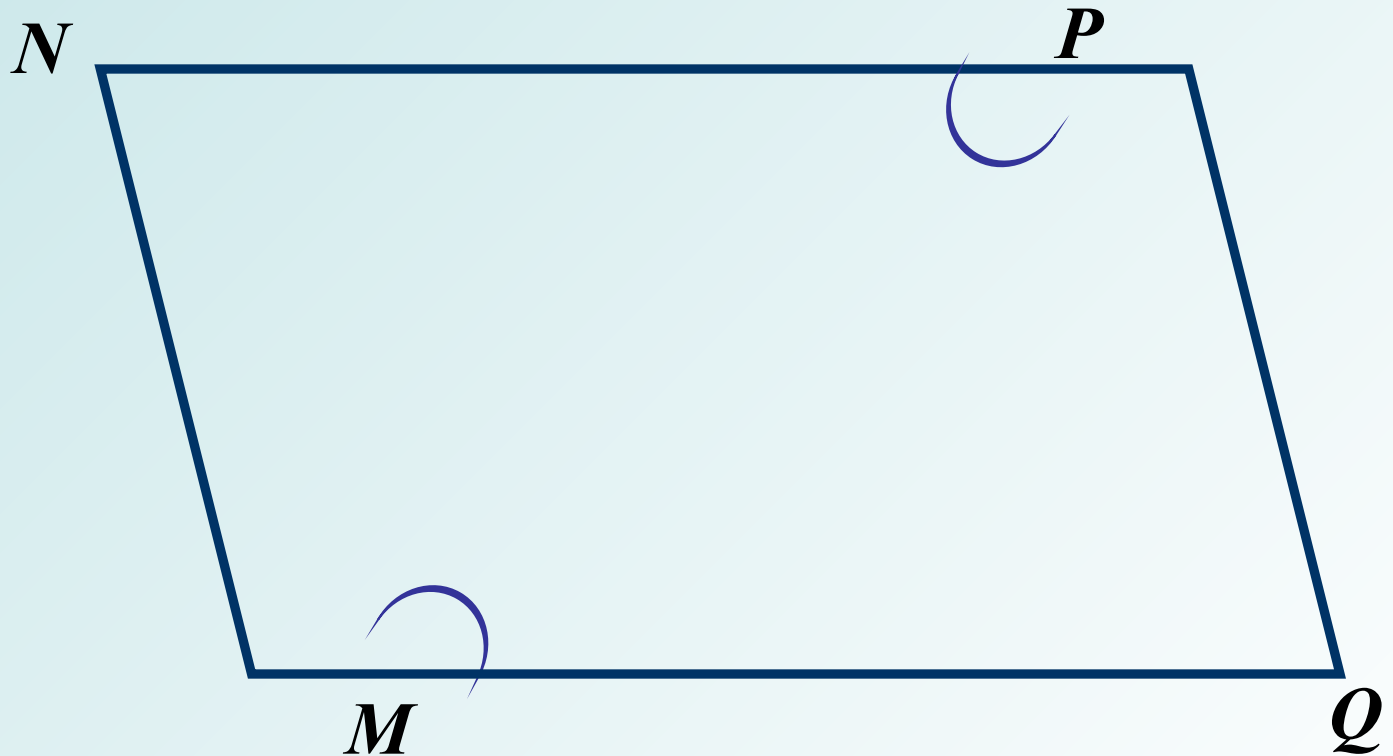

5.

Дано:

$$\angle 1 = \angle 2 = \angle 3$$

Доказать:

$ABCD$ – параллелограмм

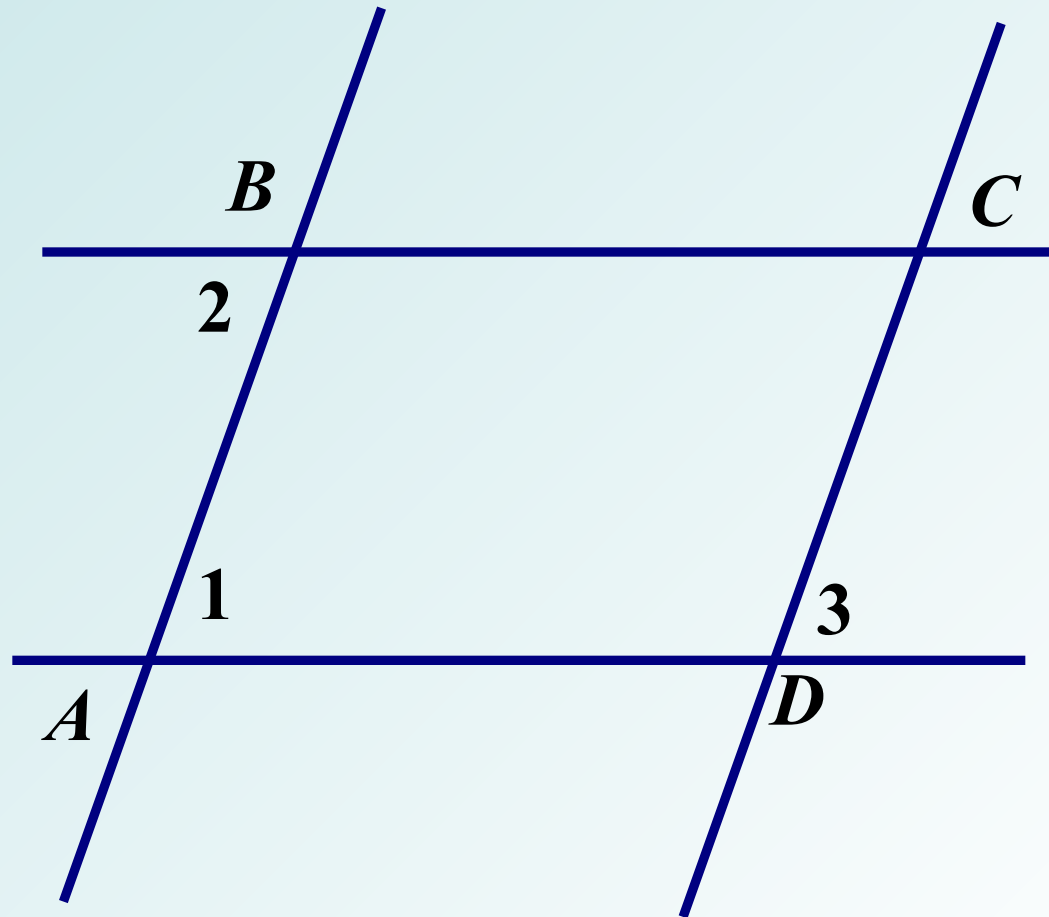

6.

Дано:

a) $\angle 1 = 70^\circ$; $\angle 3 = 110^\circ$; $\angle 2 + \angle 3 = 180^\circ$

á) $\angle 1 = \angle 2$; $\angle 2 \neq \angle 4$

Вопрос:

βâëÿåòñÿ èè ABCD ìàðàëëååïã ðàìì

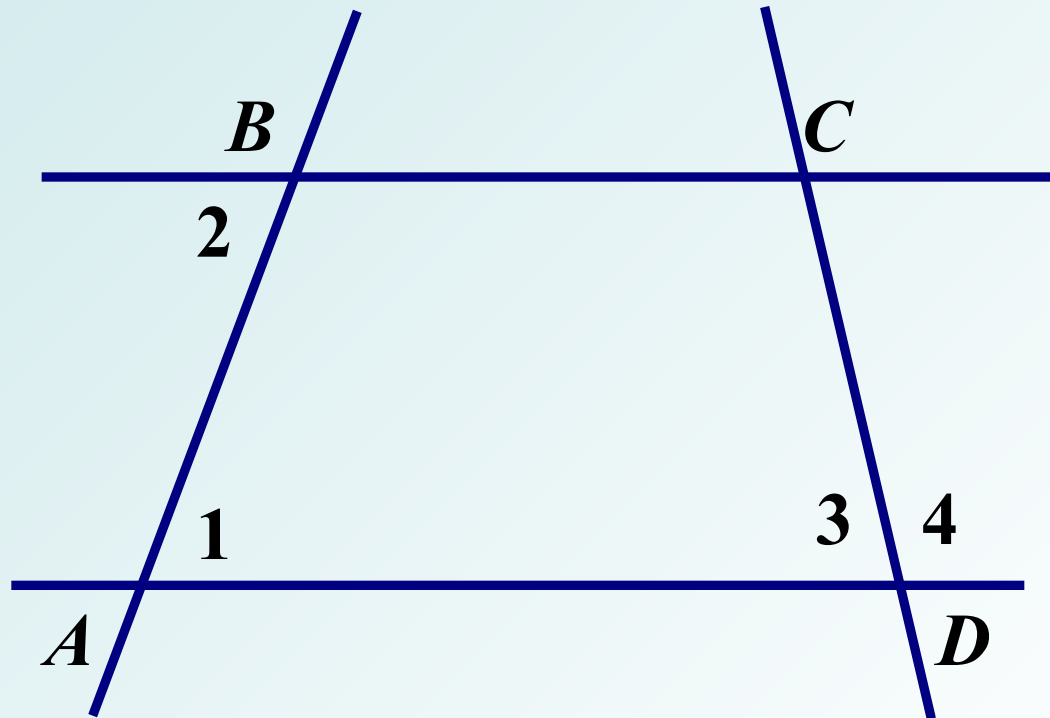

7.

Дано: $ABCD$ – параллелограмм

Найти: $\angle C, \angle D$

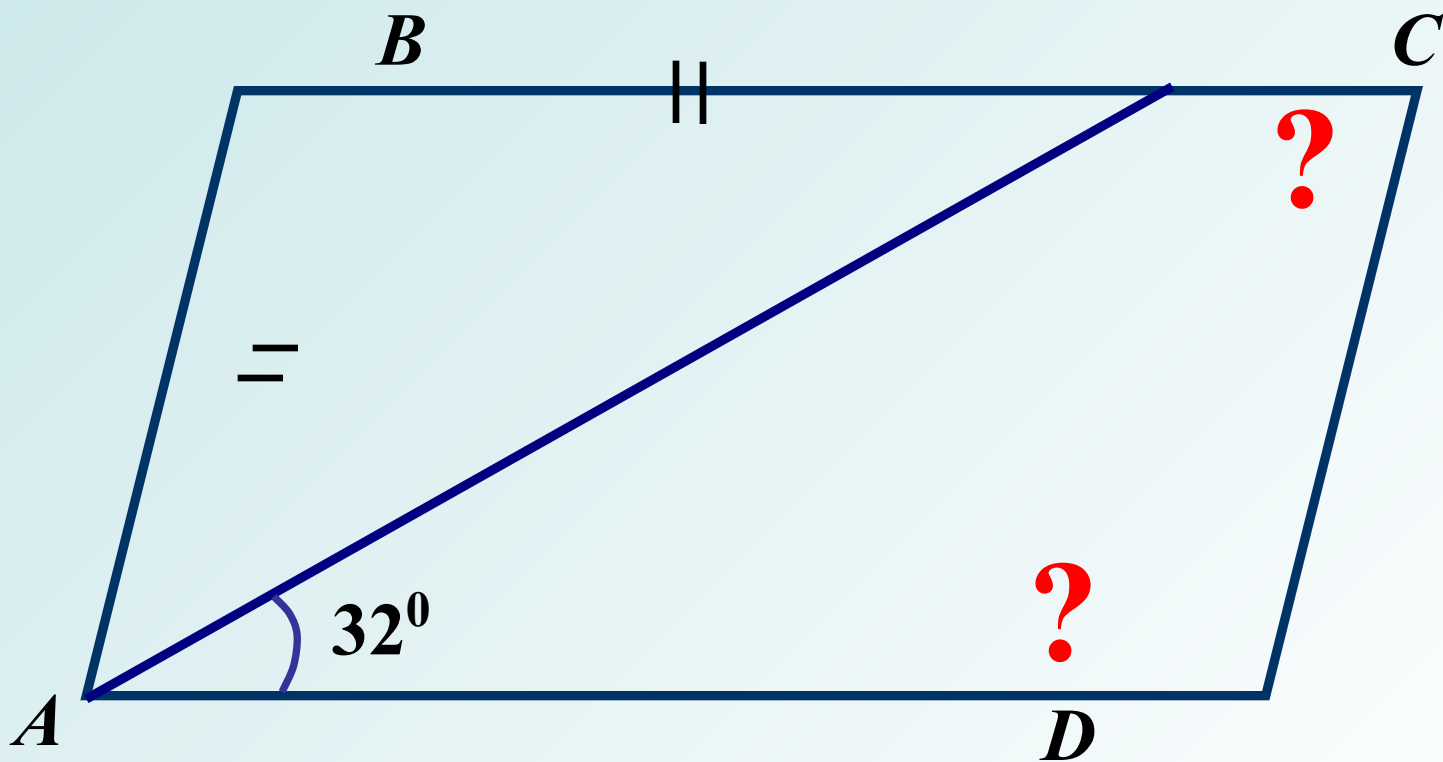

8.

Дано: $MNKP$ – \square

Найти: MP ; PK

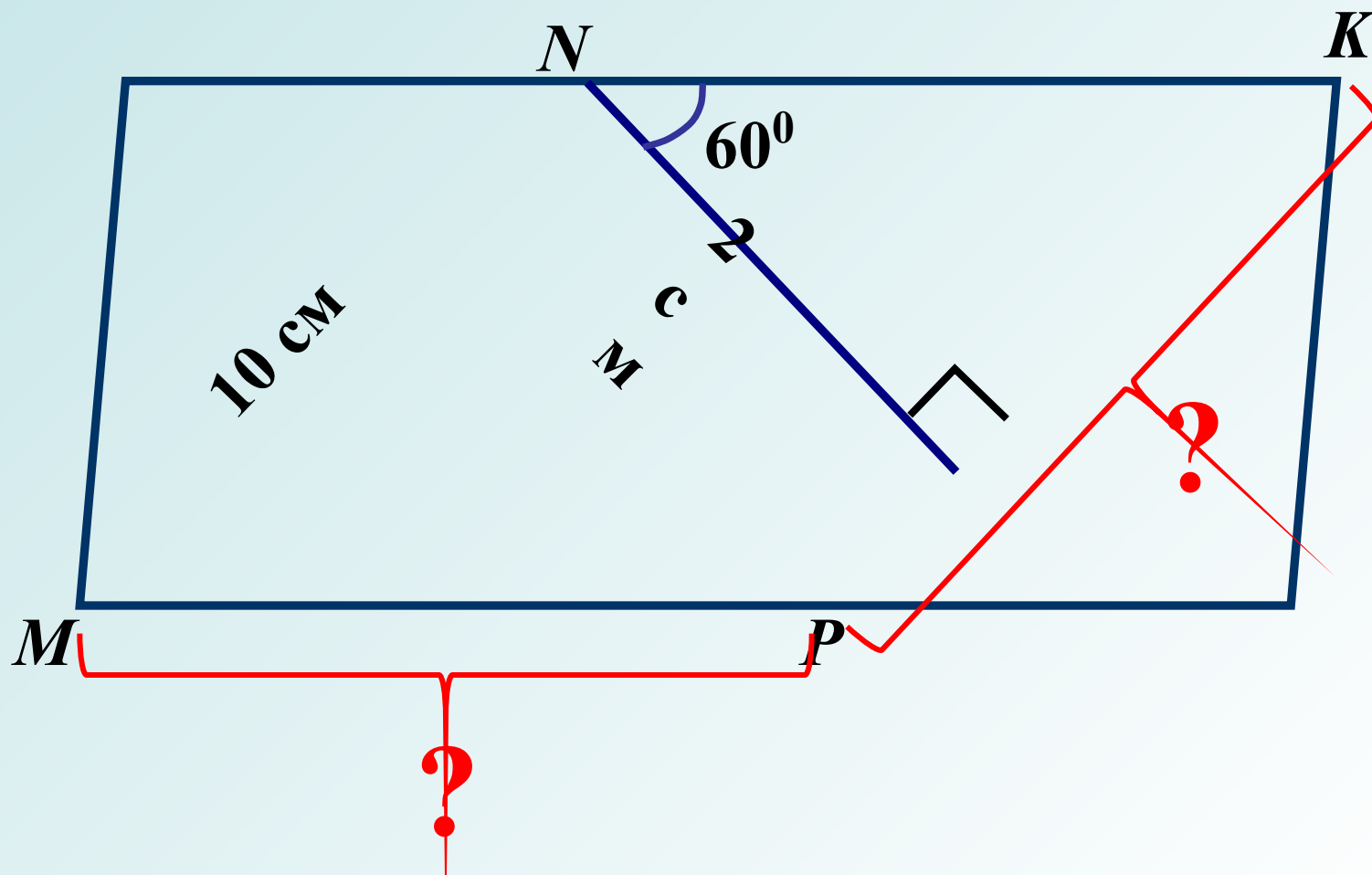

9.

Найти:

óãëû ìàðàëëäëîã ðàìà ABCD

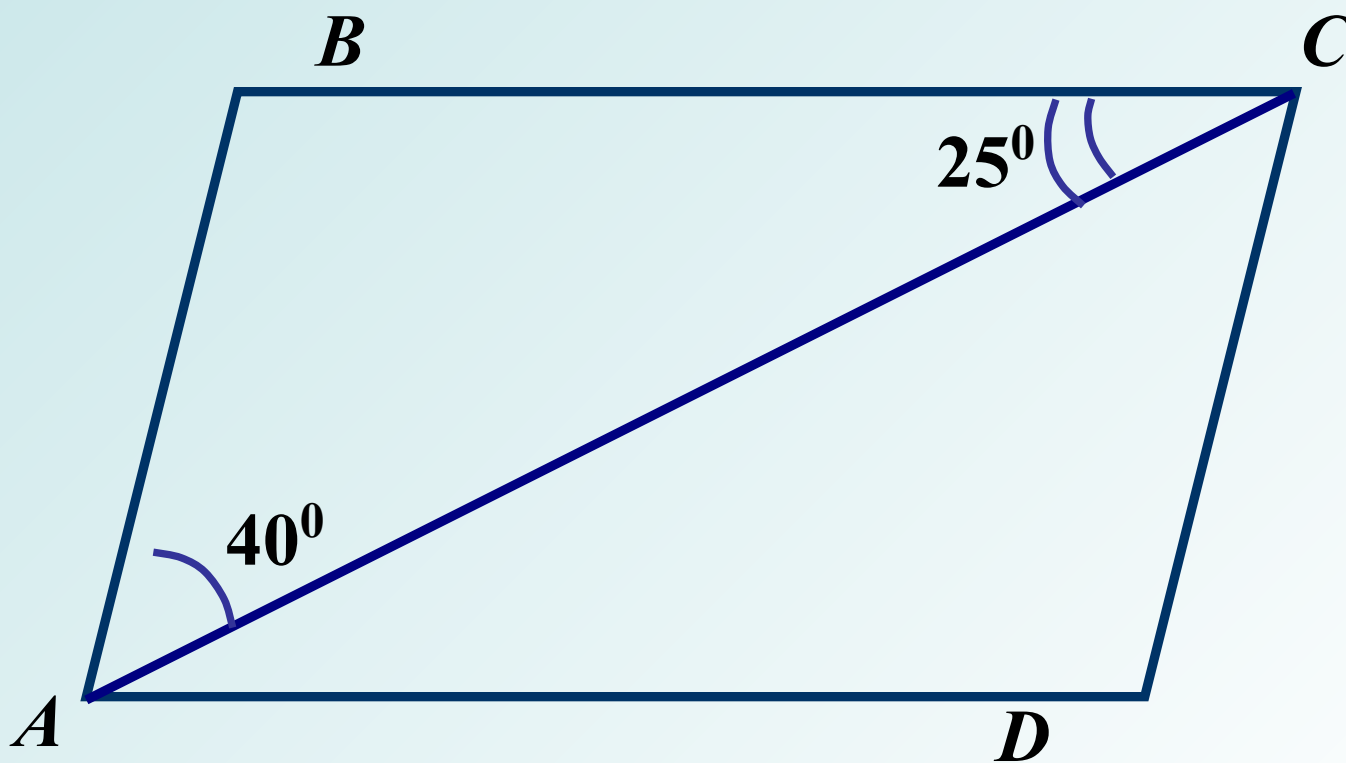

10.

Дано: $ABCD$ – ïàðàëëäëïã ðàìì

Найти: P_{ABCD}

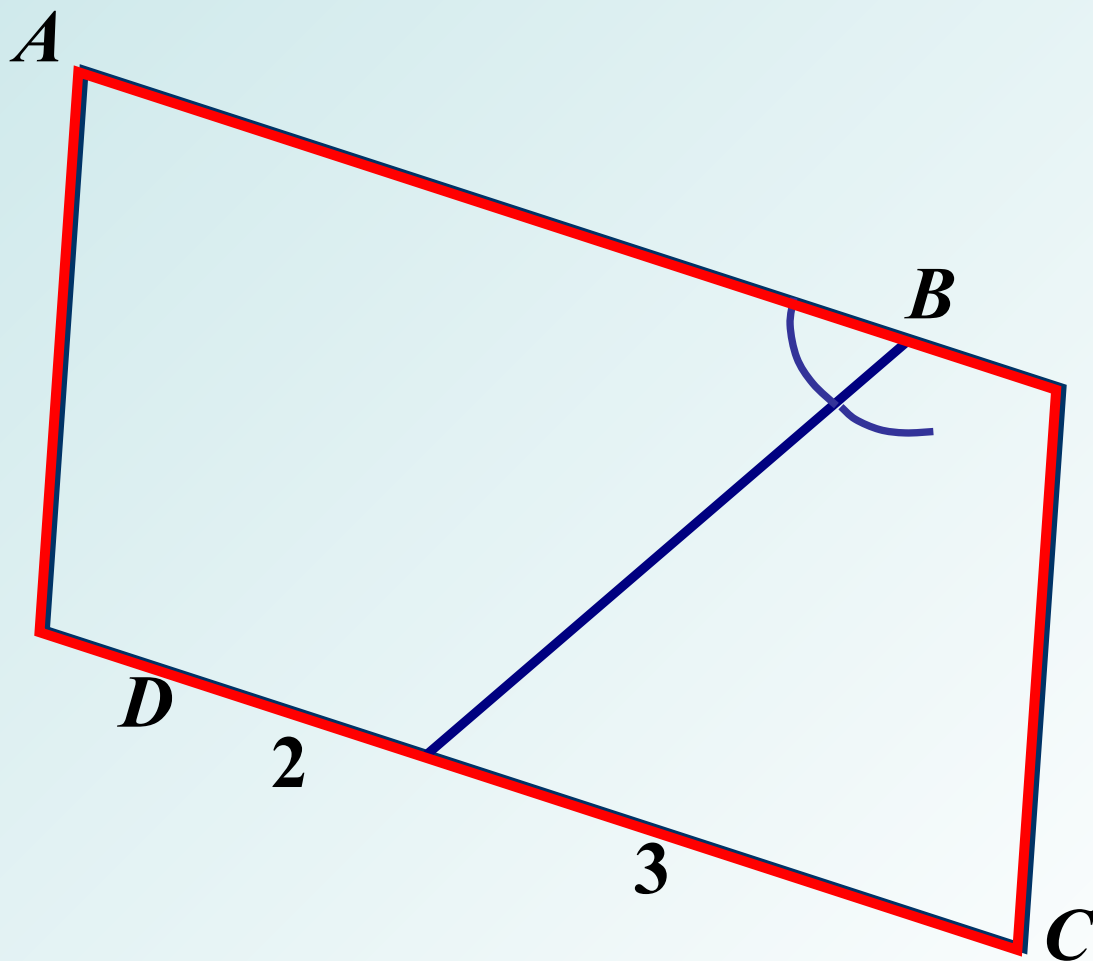

11.

Дано: $ABCD$ – параллелограмм

Найти: AD

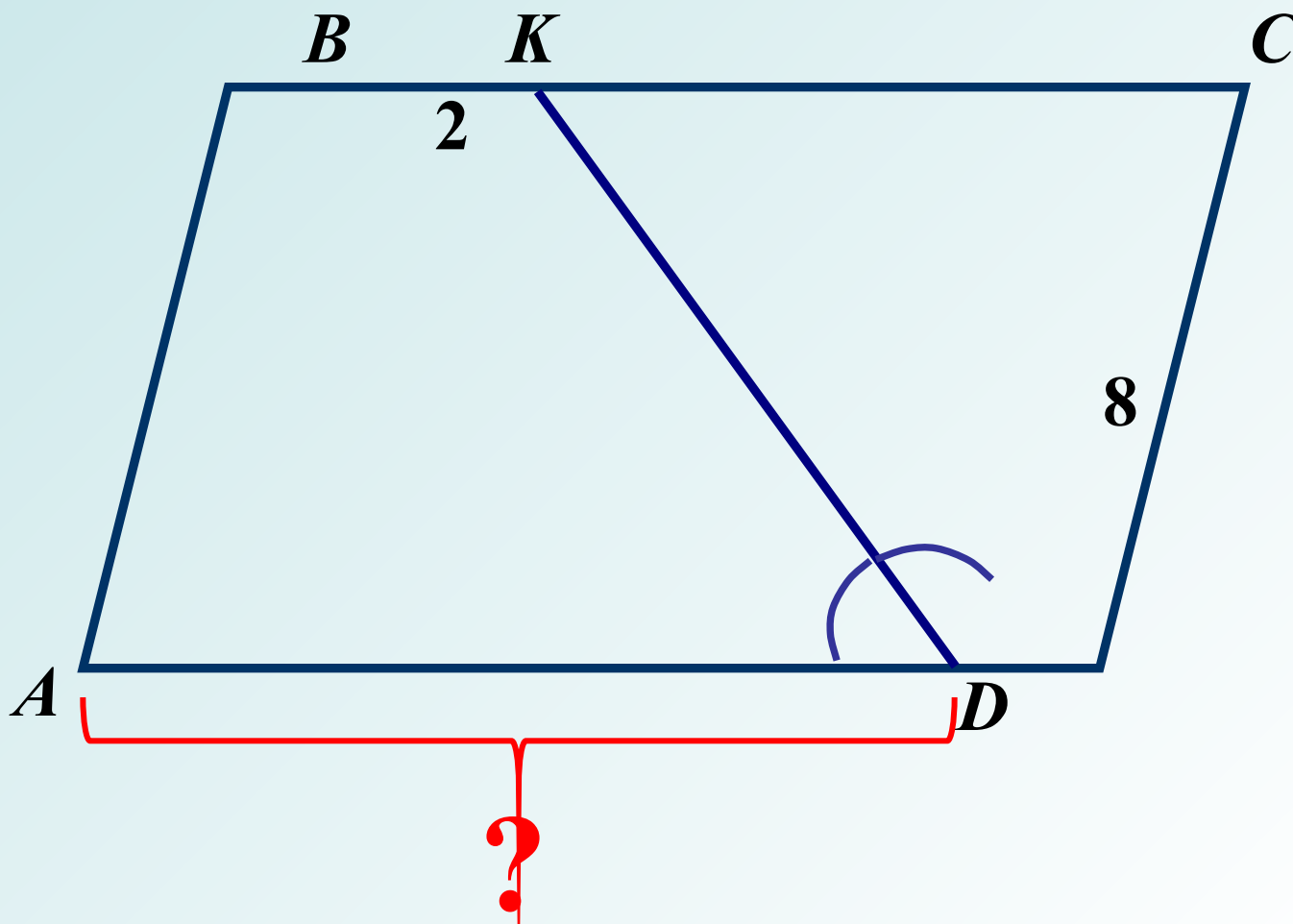

12.

Дано: $ABCD$ – ïàðàëëäëïã ðàì

Найти: P_{ABCD} , $\angle AED$

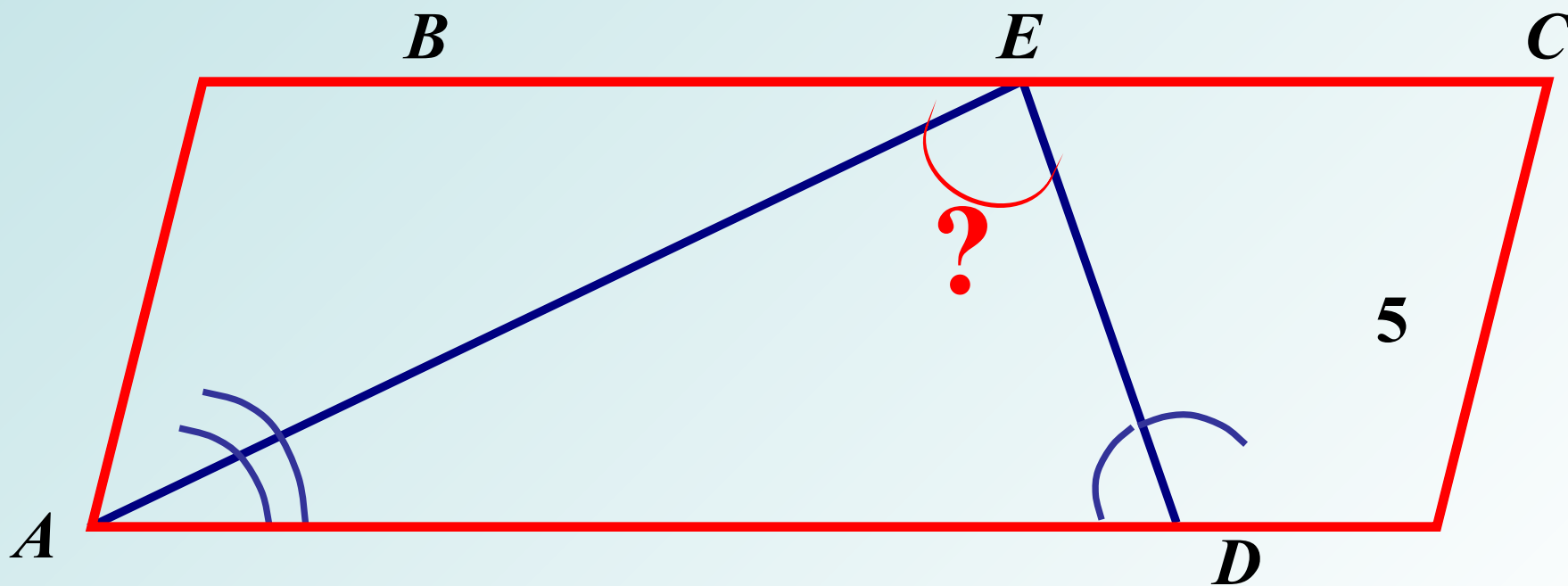

13.

Дано: $NBFD$ – трапеция
 $AD = 4$ см, $NB = 5$ см

Найти: AN , CD

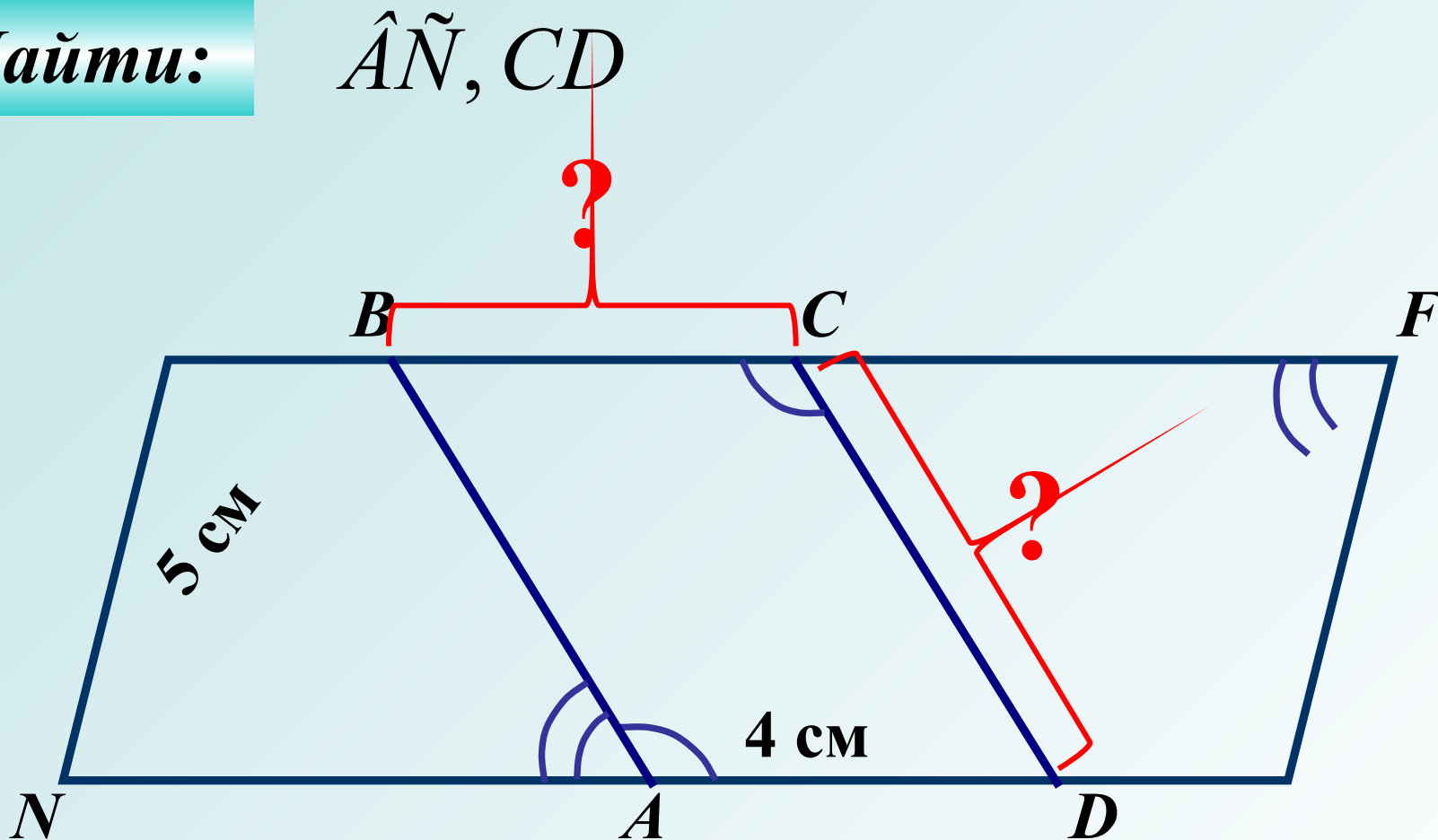

14.

Дано: $ABCD$ – параллелограмм

$$P_{MNKP} = 20 \text{ см}^2$$

Найти: MN, MP

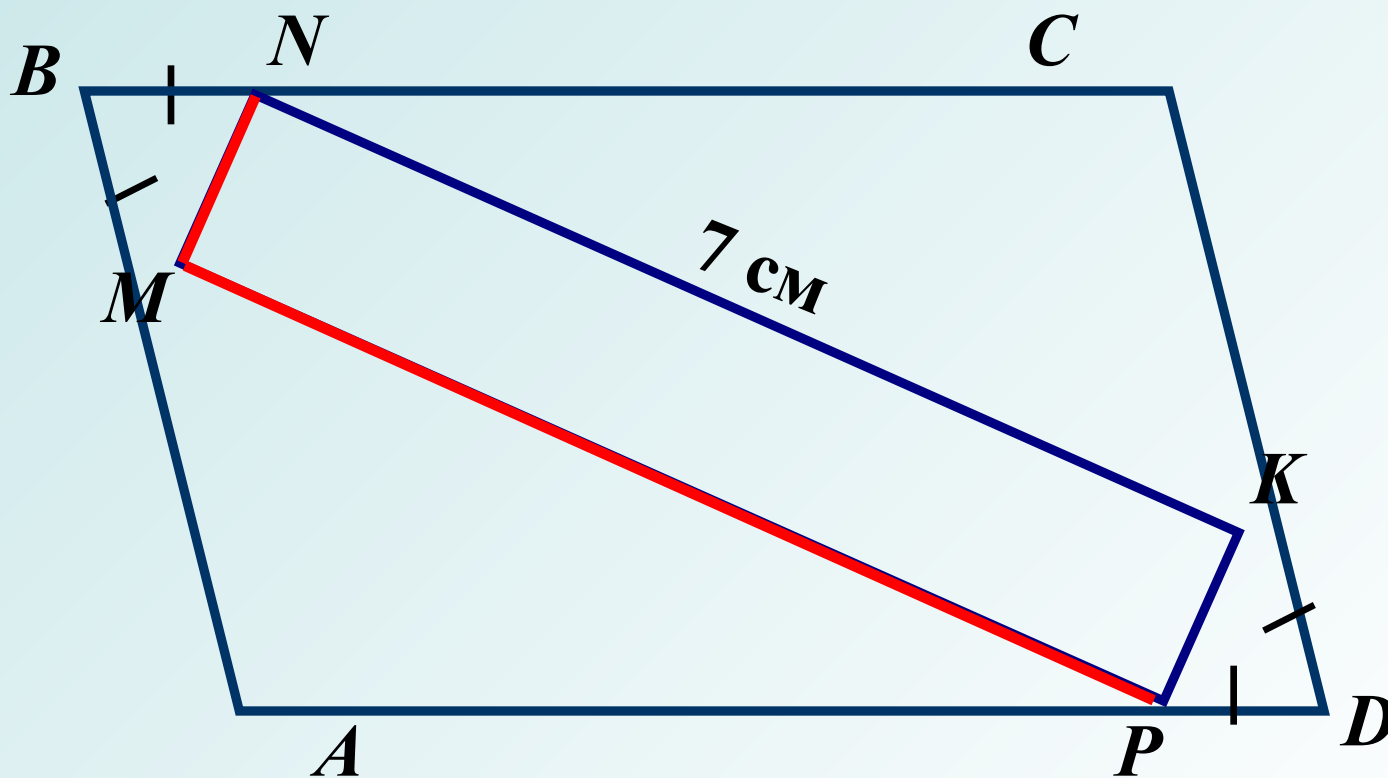

15.

Дано:

$BNDM$ – параллелограм
 $AB : BC = 4 : 5$, $P_{ABCD} = 18$

Найти:

AD , DC

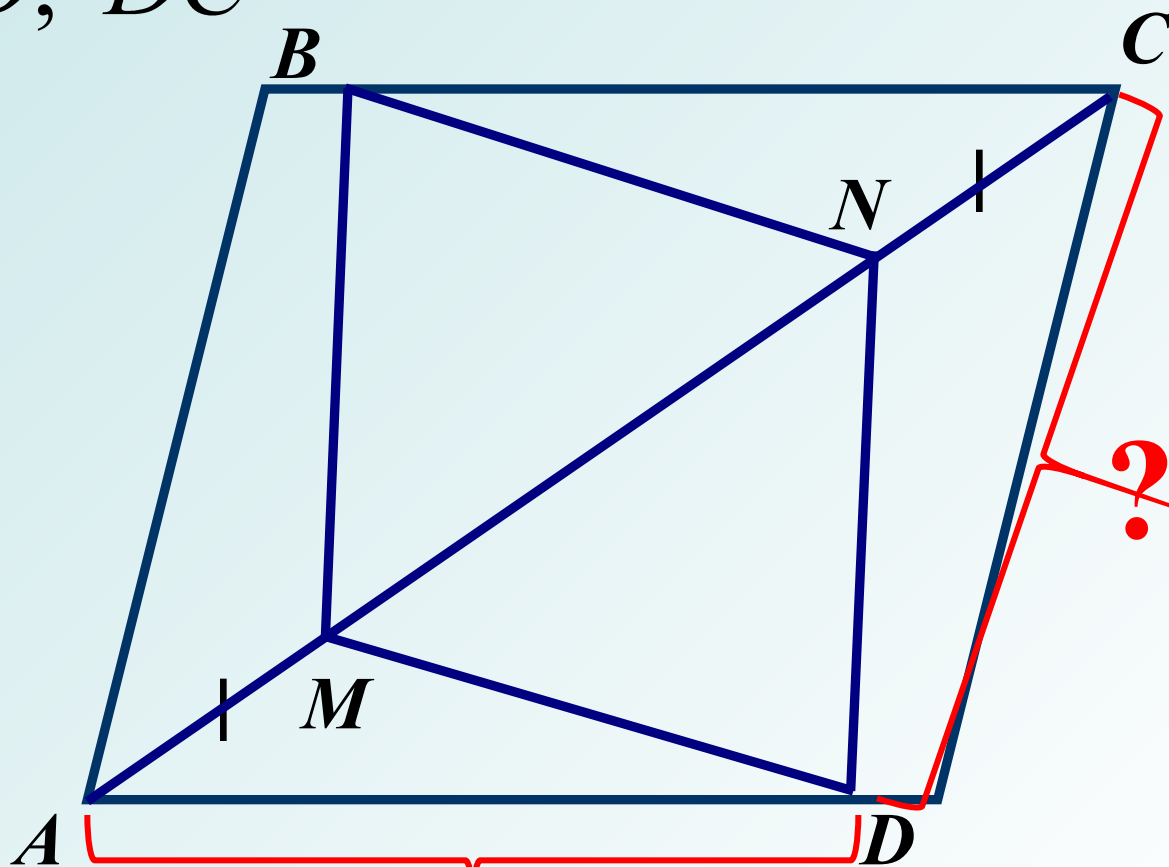

16.

Дано: $ABCD$ – о́дàìàòöèÿ

Найти: $\angle A_1A_2A_3$

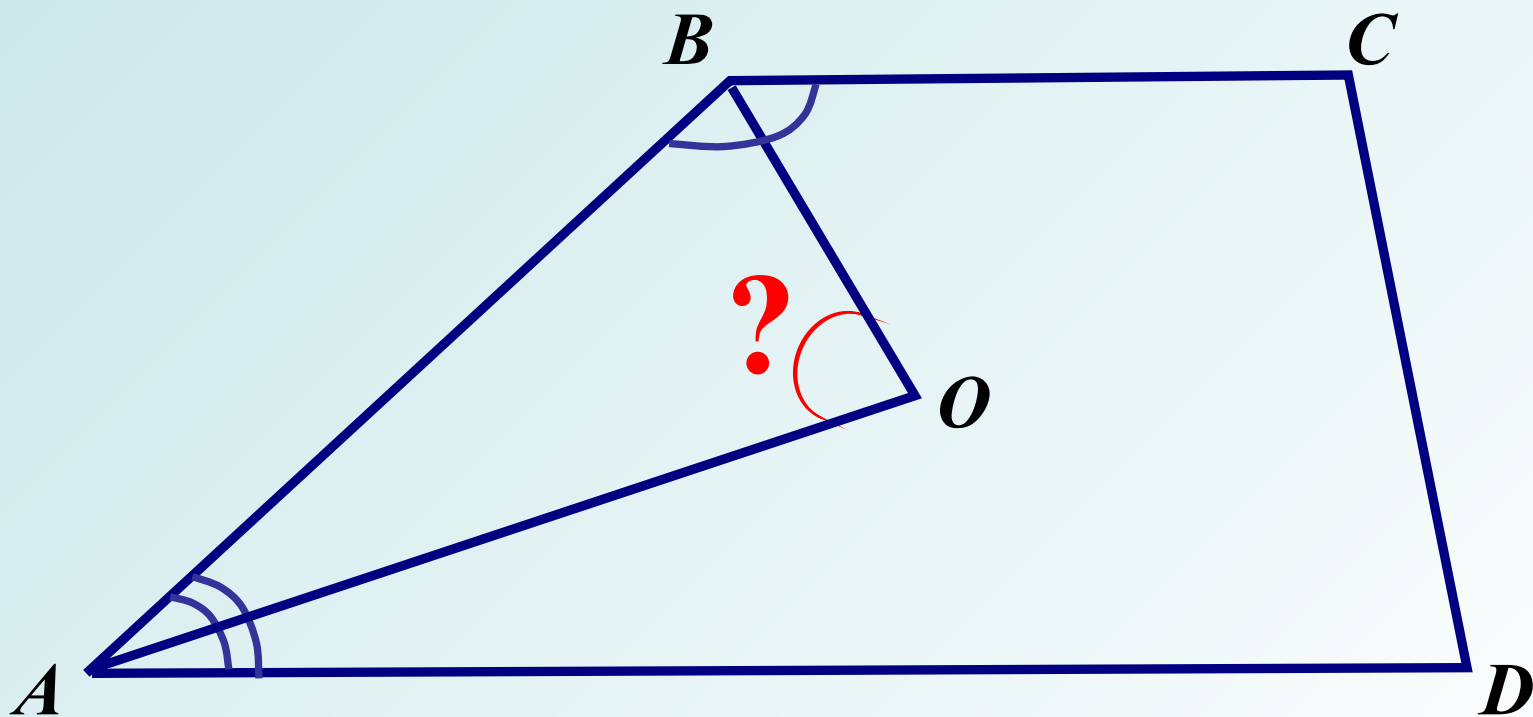

17.

Дано: $ABCD$ – òđàìáöèÿ

Найти:

óãëÿ òđàìáöèè

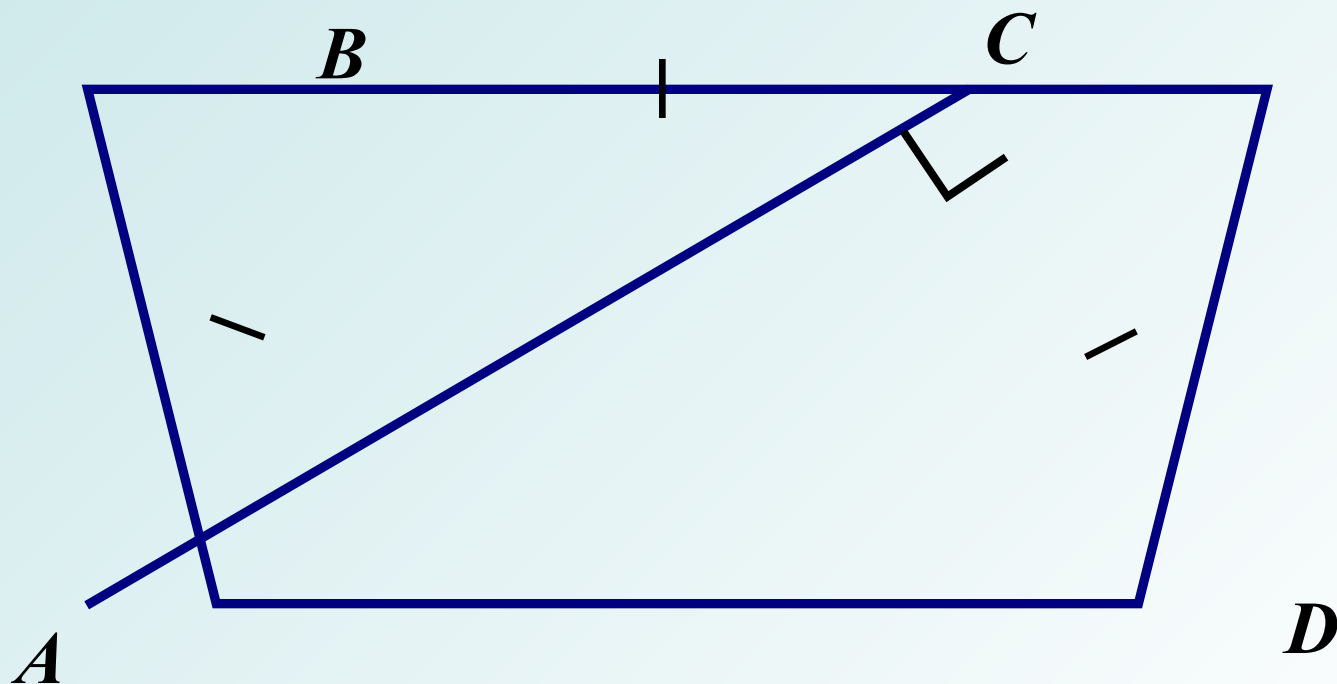

18.

Дано:

$ABCD$ – $BC \parallel AD$ $BE \parallel CD$

Найти:

$\angle B$

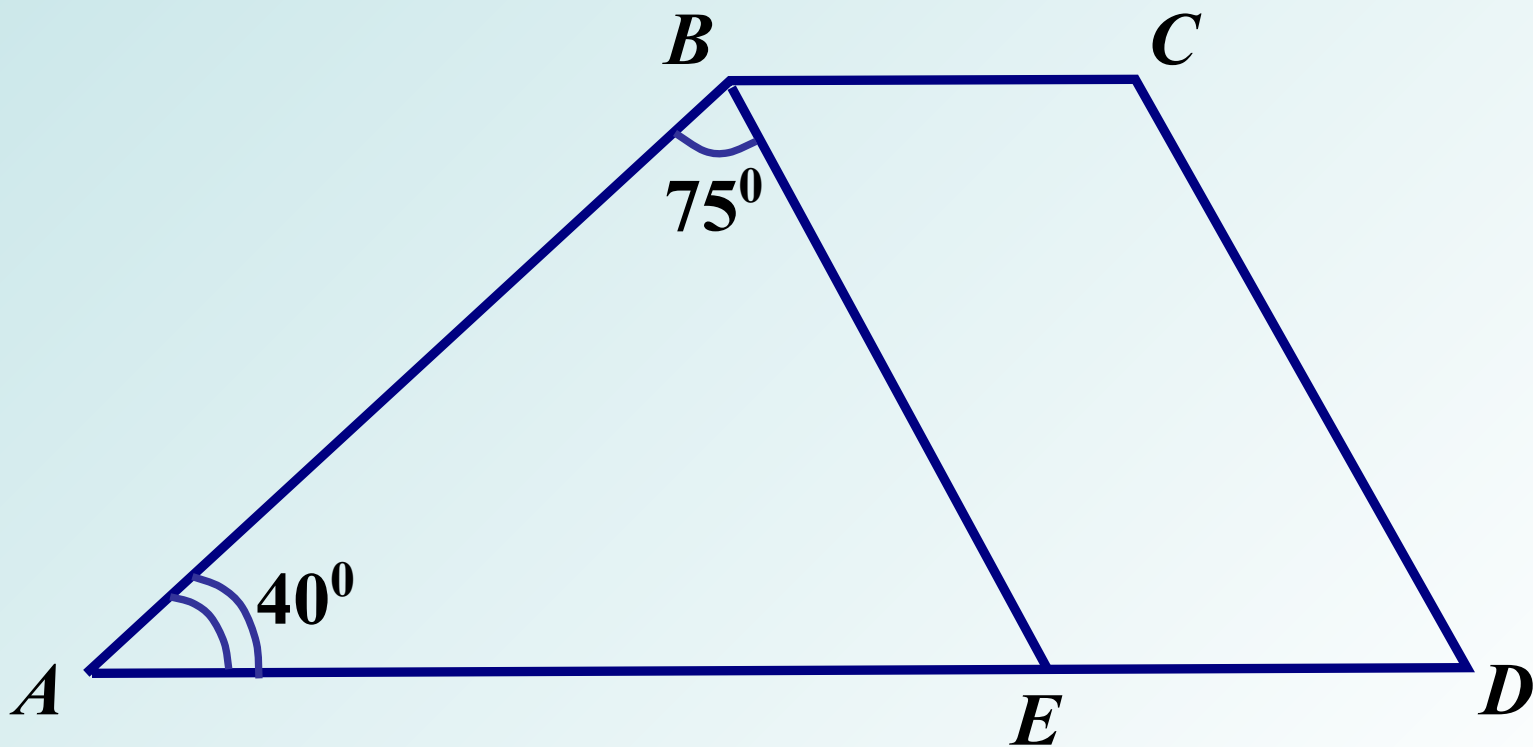

19.

Дано:

$ABCD$ – òđàìäöèÿ

Найти:

$\hat{A}\tilde{N}$

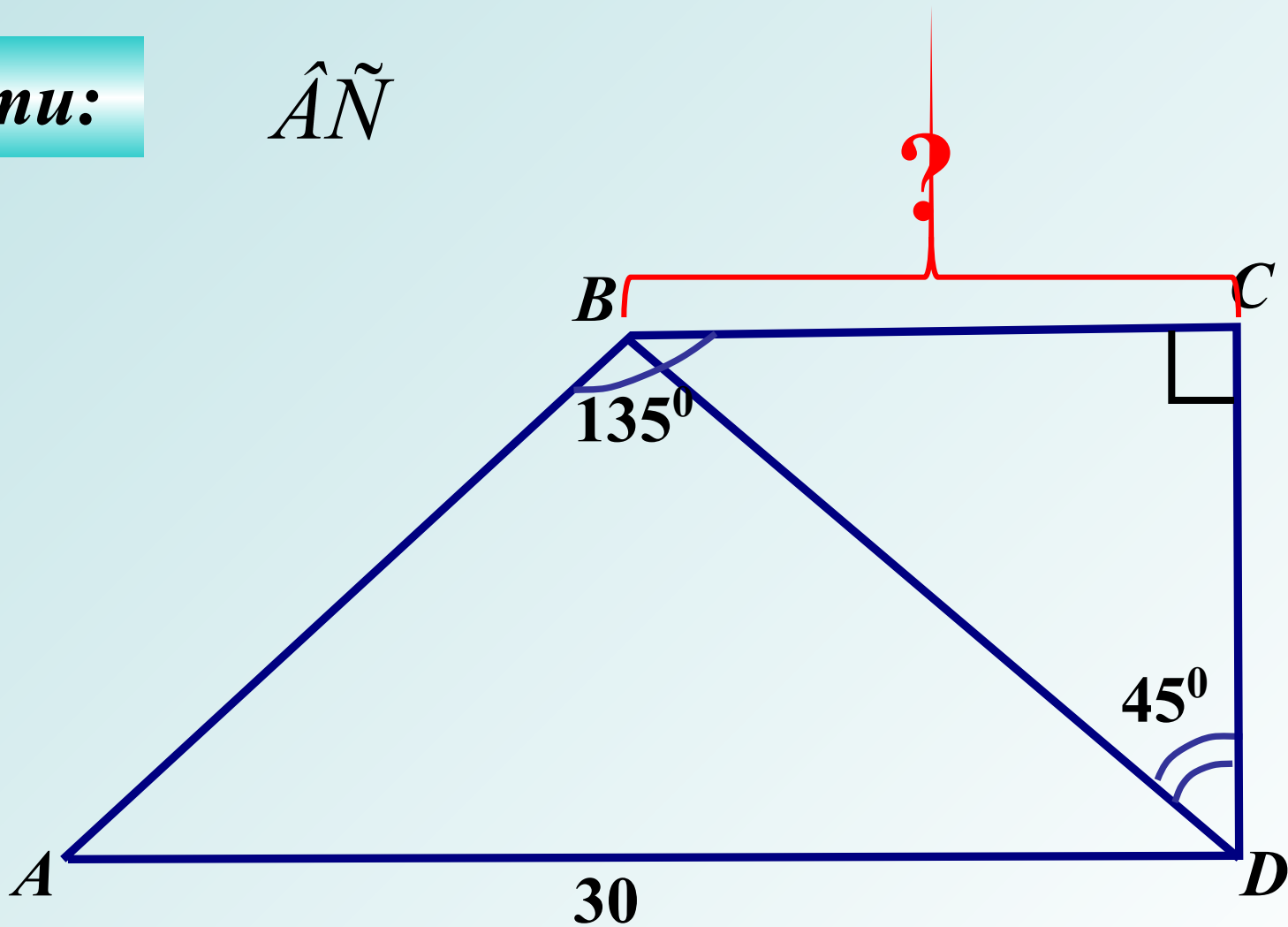

20.

Дано:

$ABCD$ – о́дàìàòöèÿ $AD = 15$

Найти:

\tilde{NA}

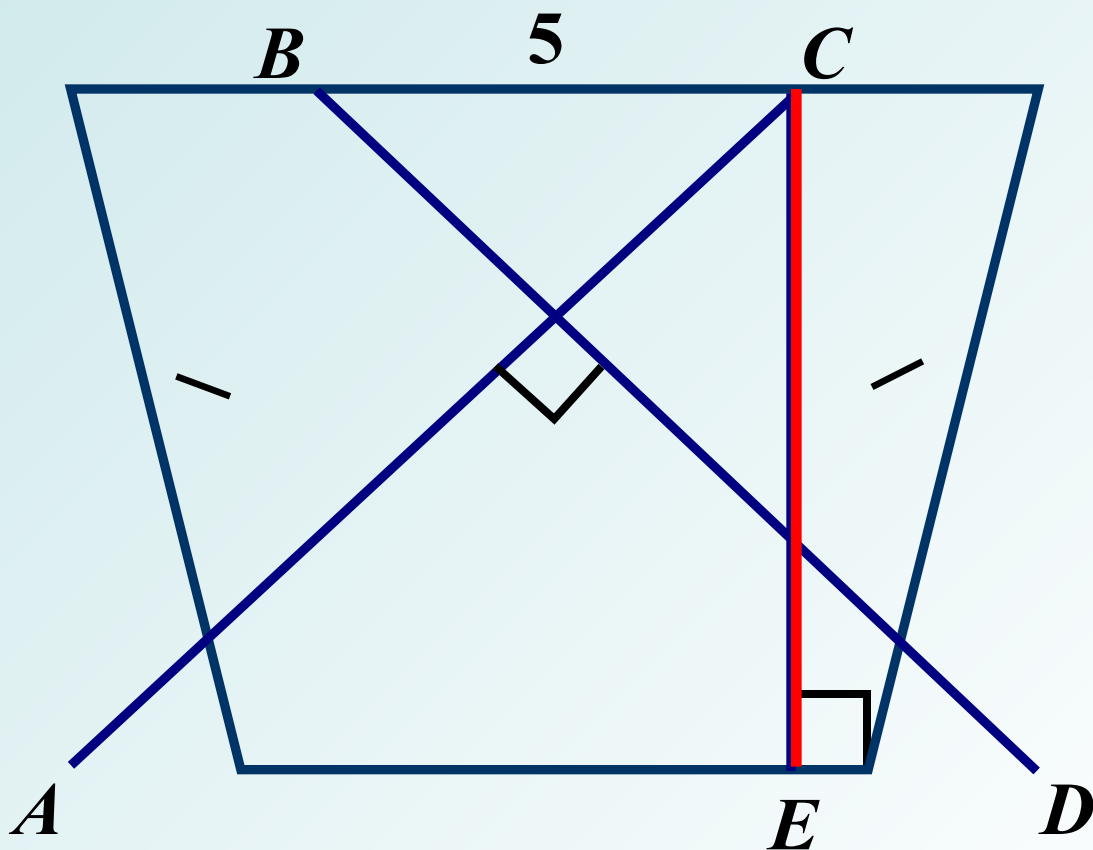

21.

Дано:

$ABCD$ – трапеция $AD = 15$

Найти:

P_{ABCD}

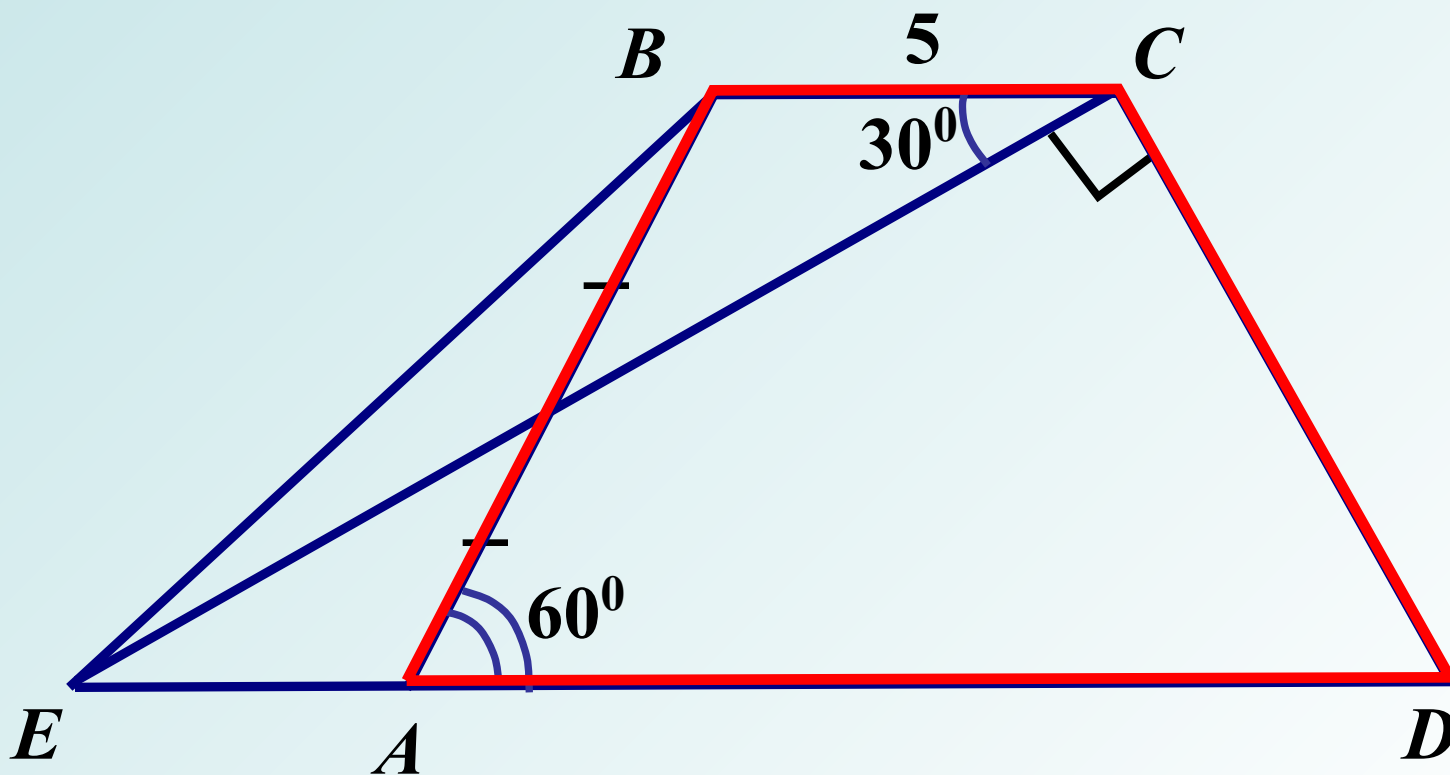

22.

Дано: $ABCI$ – о́дàìàöèÿ $AI = 7$

Найти: NI

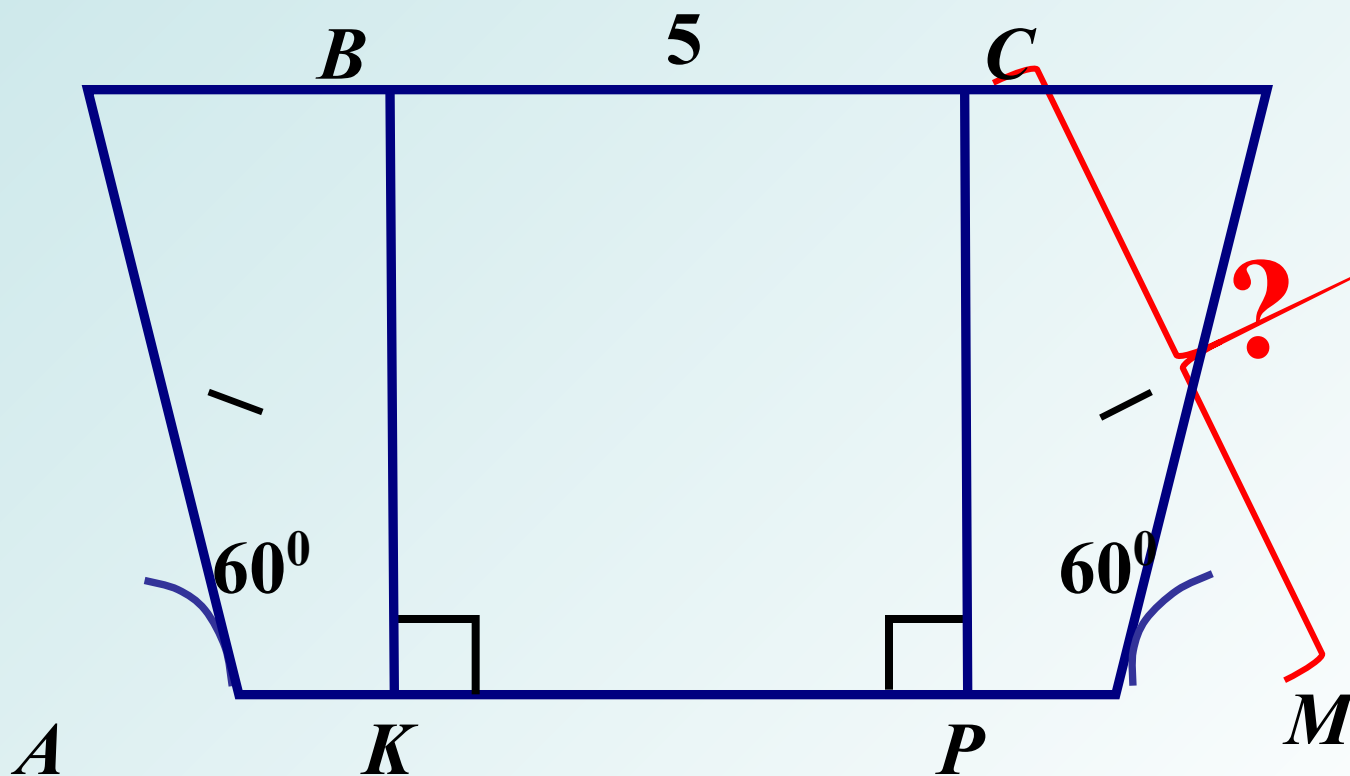

23.

Дано:

$ABCD$ – òđàìäöèÿ

Найти:

$\angle \tilde{N}$

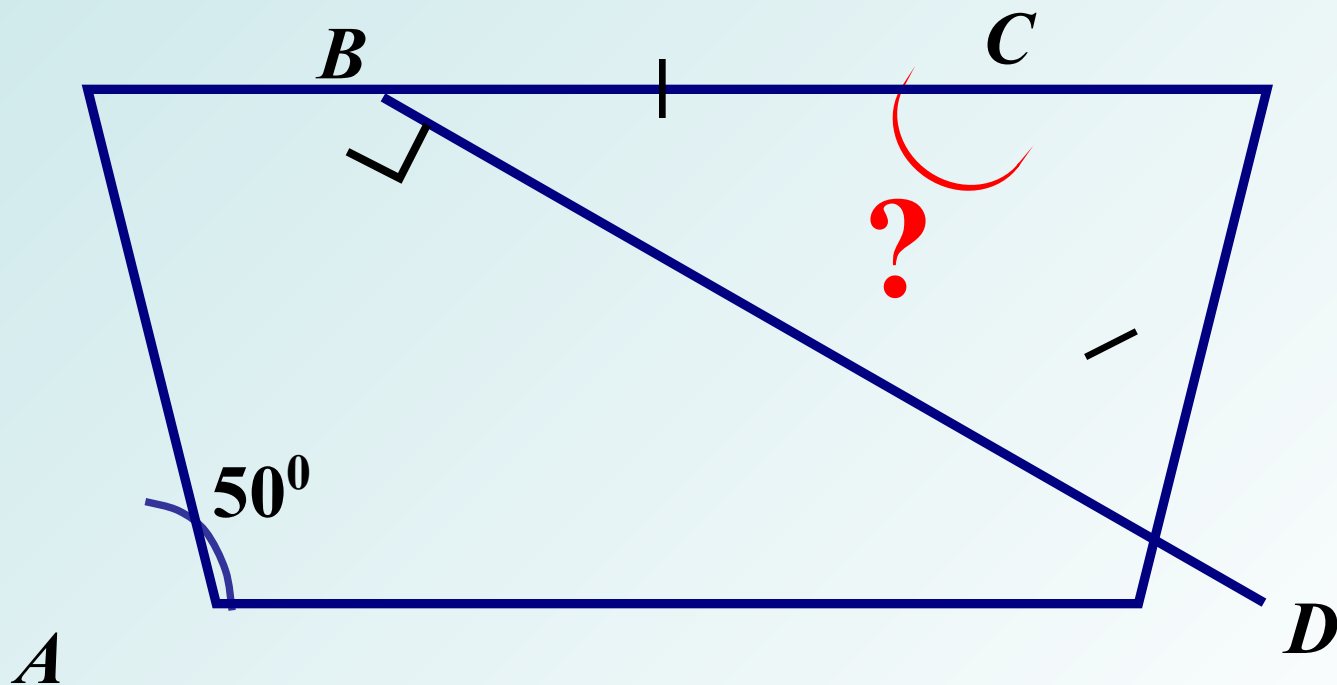

24.

Дано:

$$A_1B_1 \parallel A_2B_2 \parallel A_3B_3 \parallel A_4B_4$$

$$AA_1 = A_1A_2 = A_2A_3 = A_3A_4$$

$$AB_4 = 20\tilde{n}i$$

Найти:

$$\hat{A}_2\hat{A}_3$$

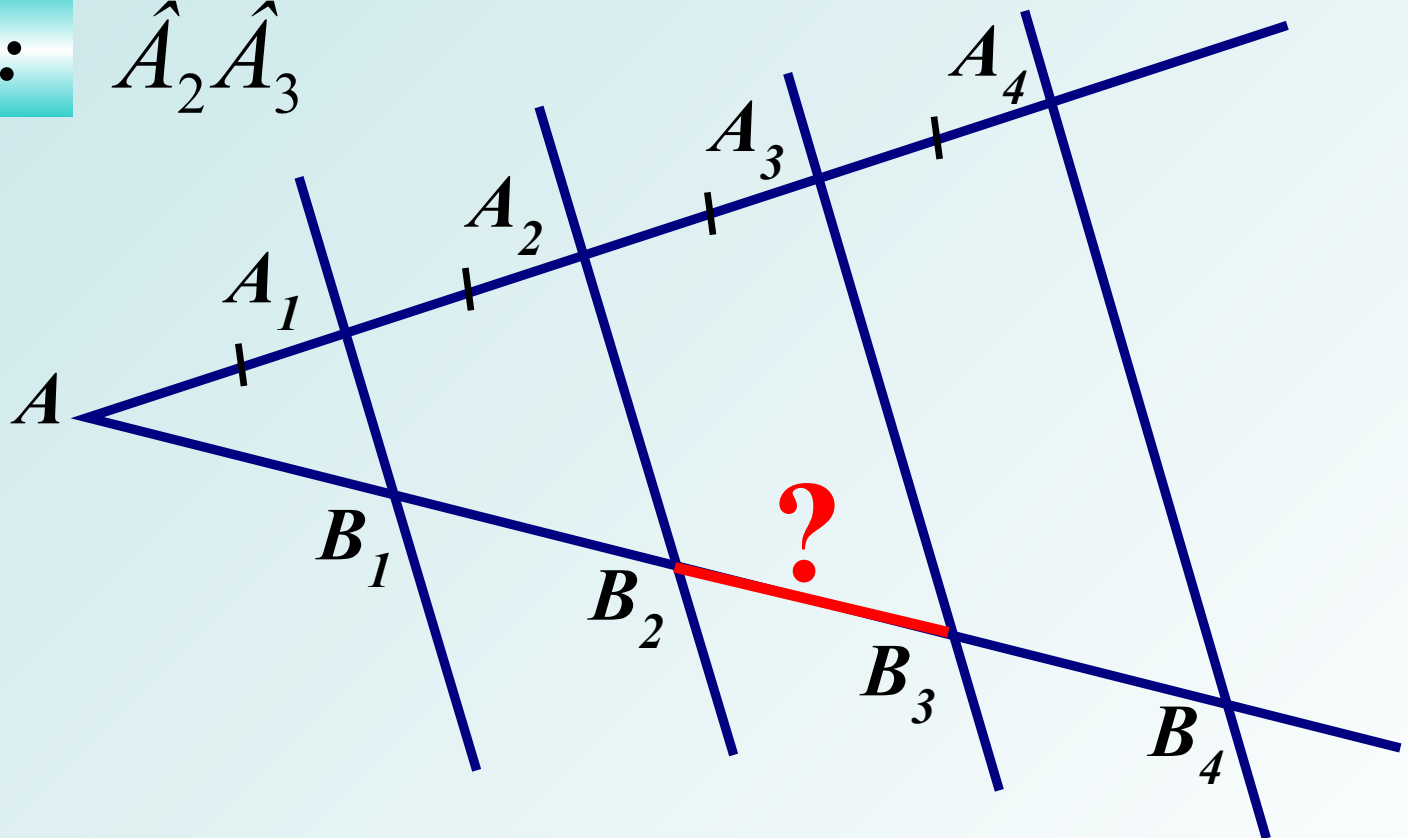

25.

Дано: $EF \parallel AC$

Найти:

P_{ABC}

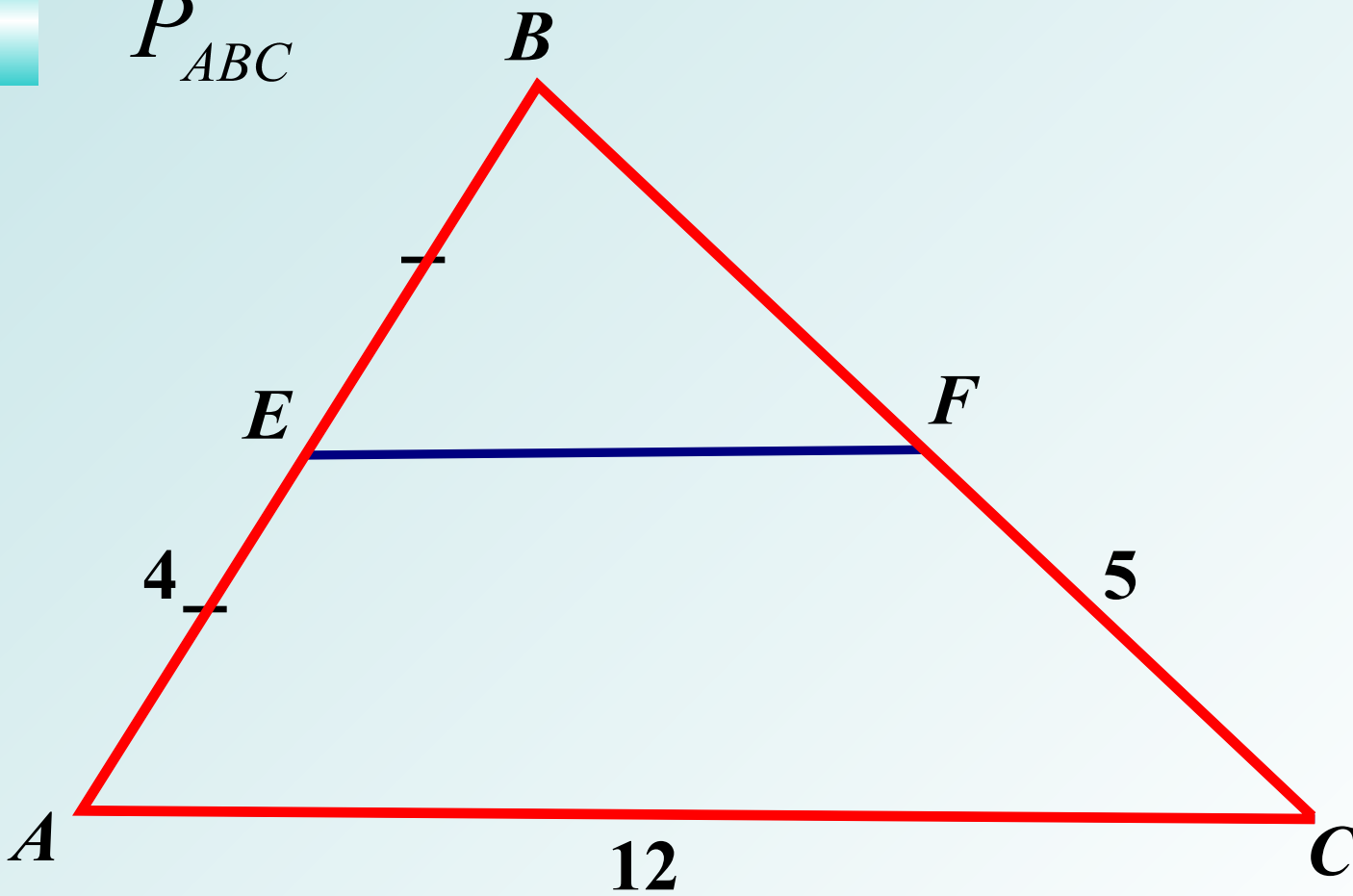

26.

Дано:

$MK \parallel BE \parallel CD$, $AD = 16$

Найти:

AK

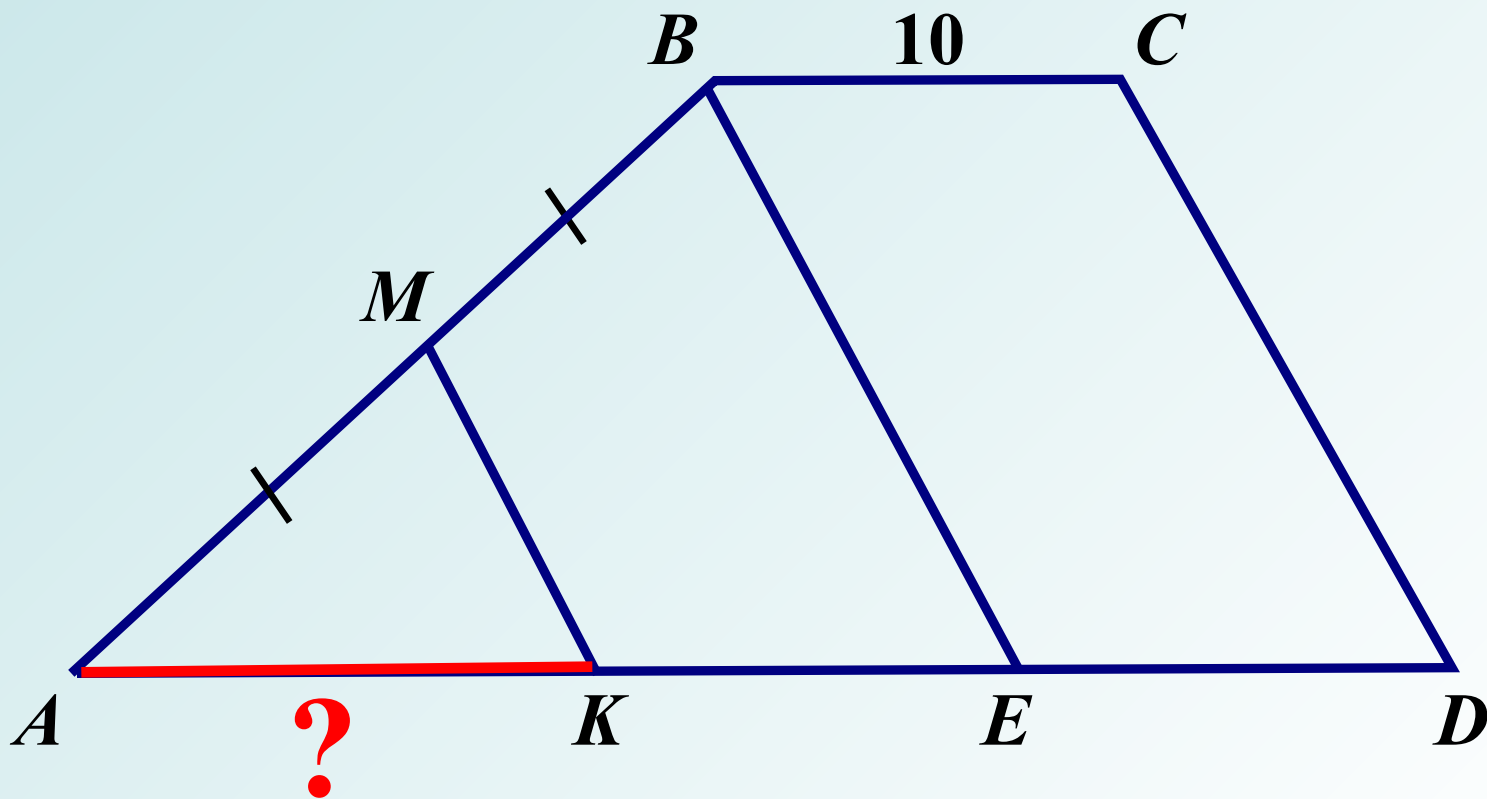

28.

Дано: $ACEK$ – \square
 $BC = 5cm$

Найти: P_{BDFM}

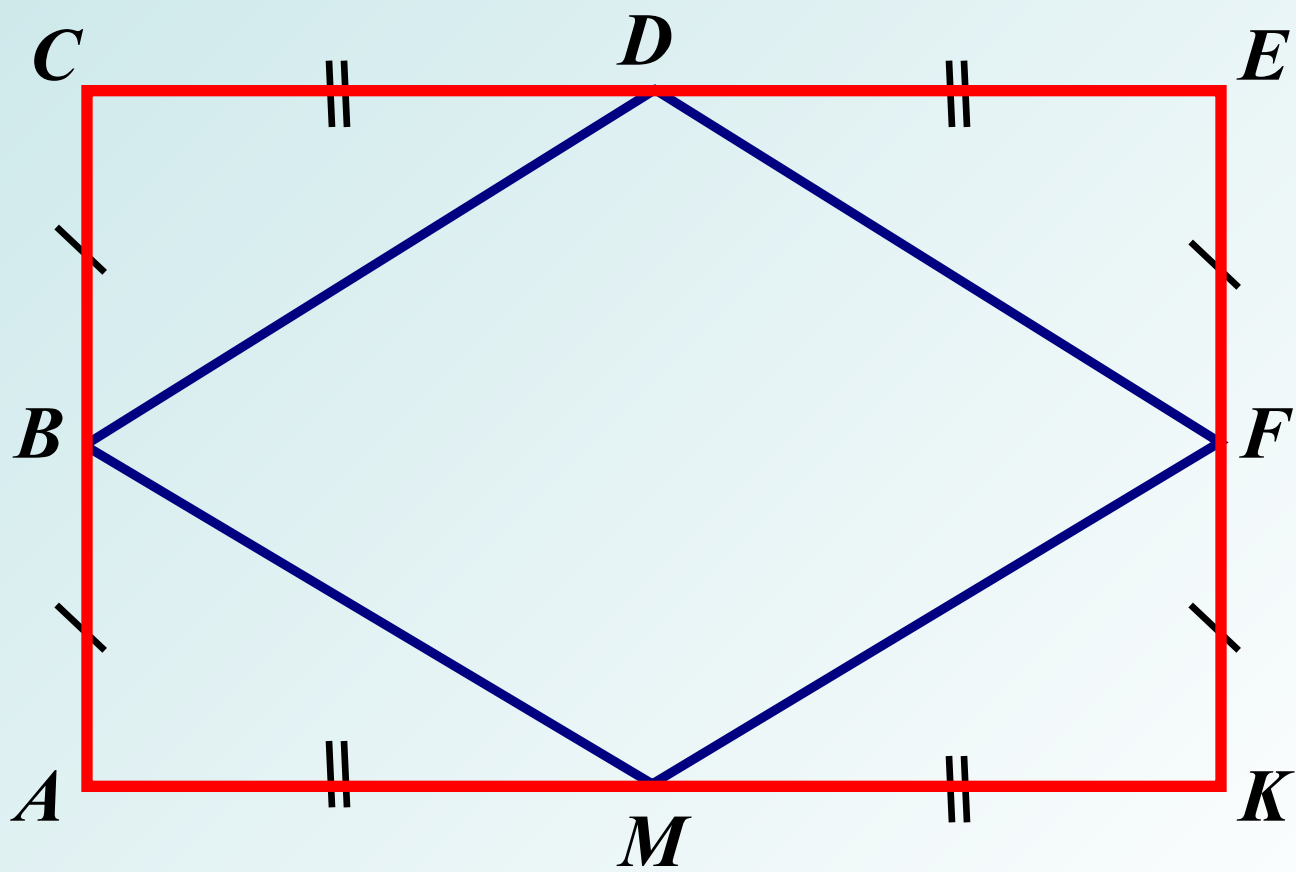

29.

Дано: $ABCD$ – $i\delta y\ddot{i}\hat{o}\tilde{a}\hat{i}\ddot{e}\ddot{u}$ $i\grave{e}\hat{e}$

Найти: $\angle A\hat{I}B$, $\angle A\hat{I}\tilde{N}$

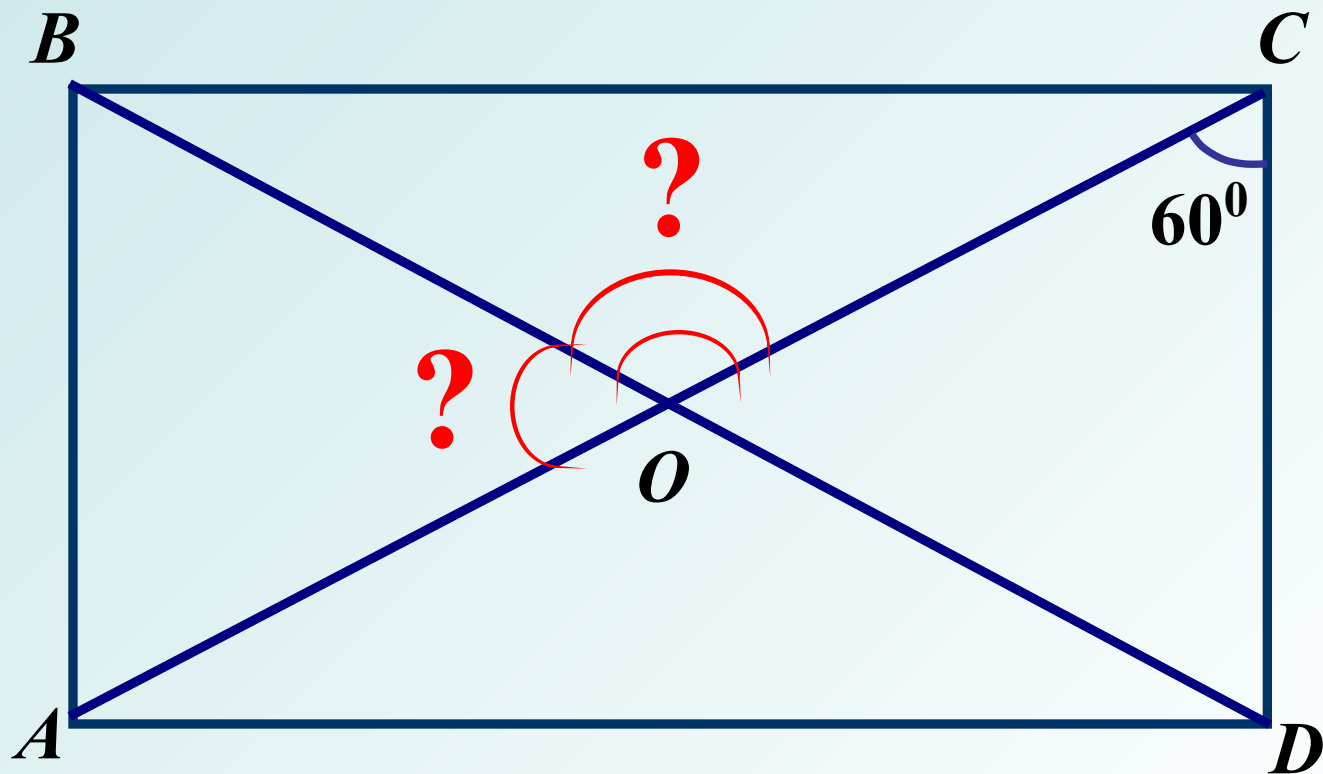

30.

Дано: $ABCD$ – ïðÿìîóãîëü íèè

Найти: AN , AA

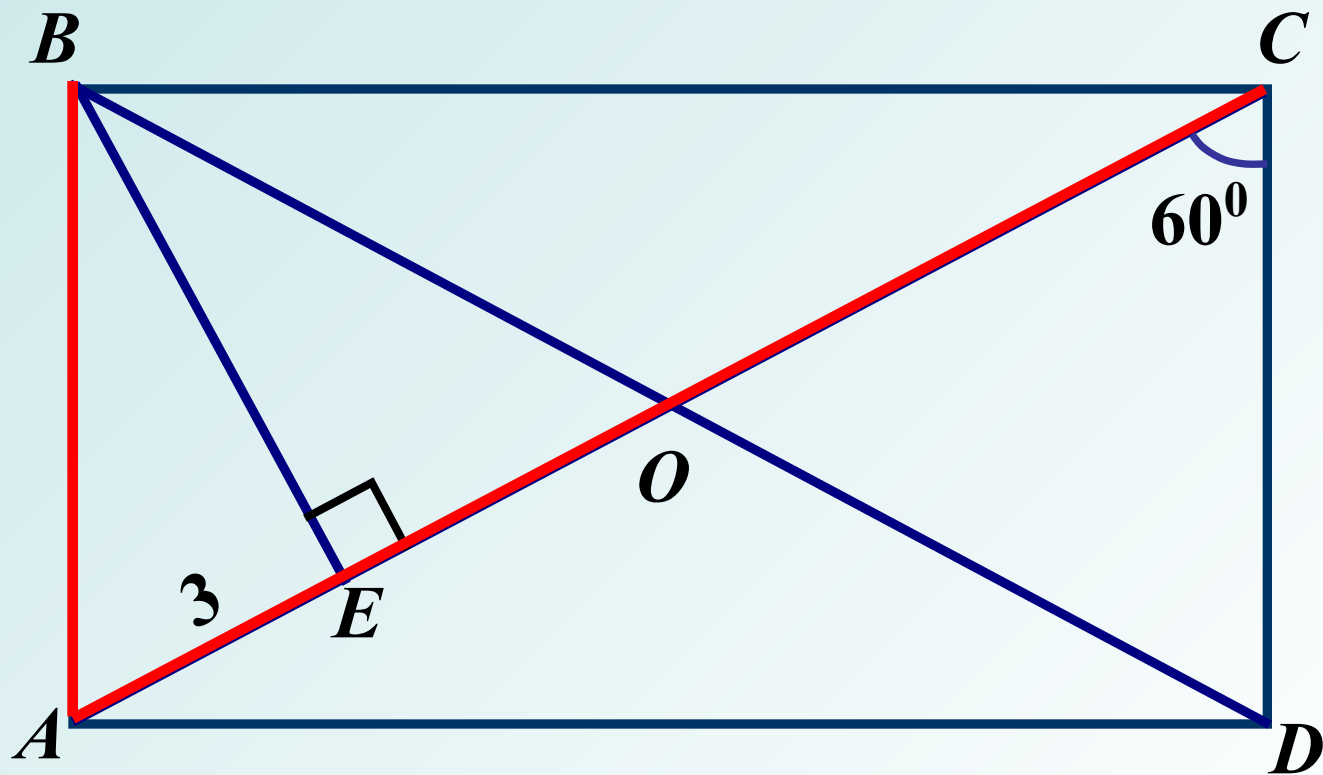

31.

Дано: $ABCD$ – прямоугольник

Найти: AD

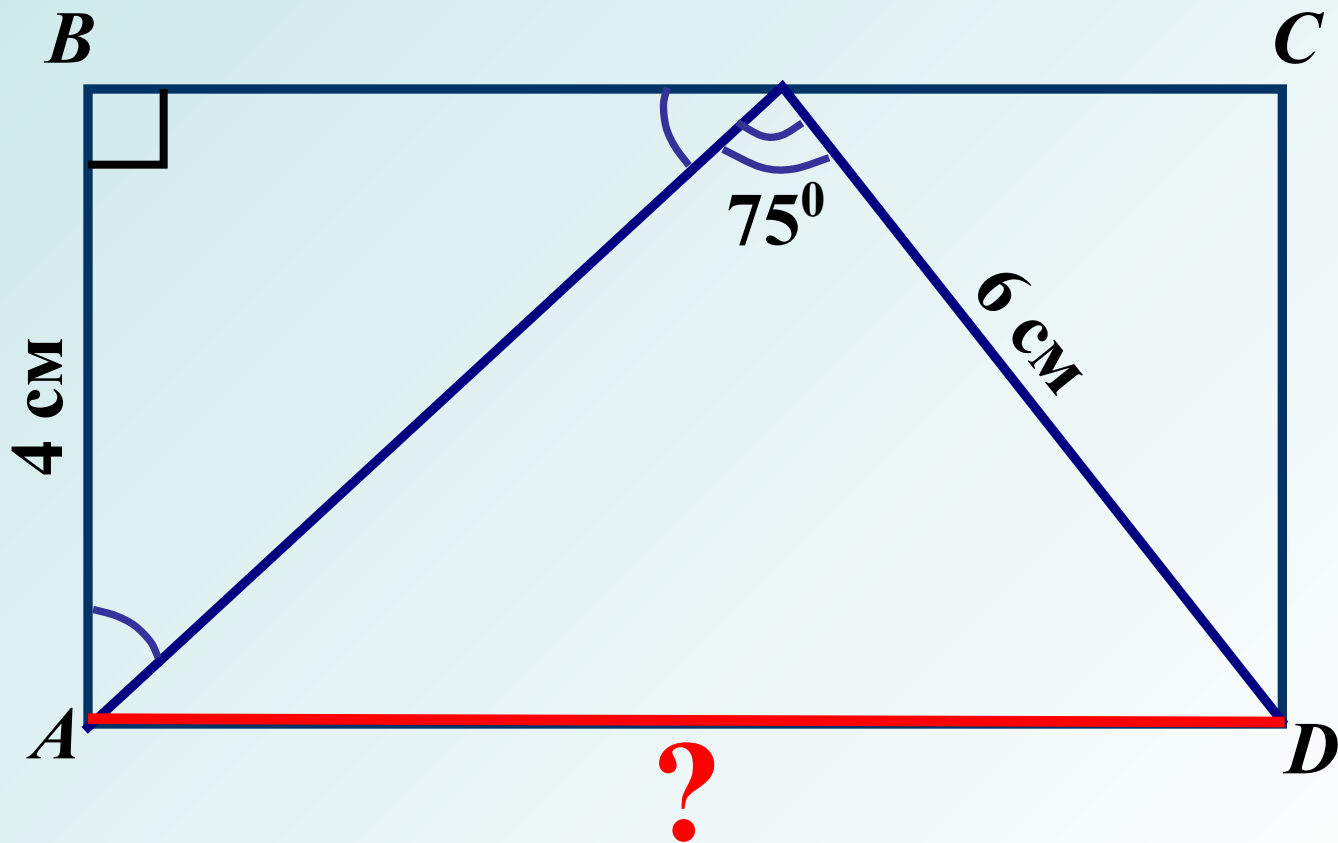

32.

Дано: $ABCD$ – діля

Найти: $MD + DN$

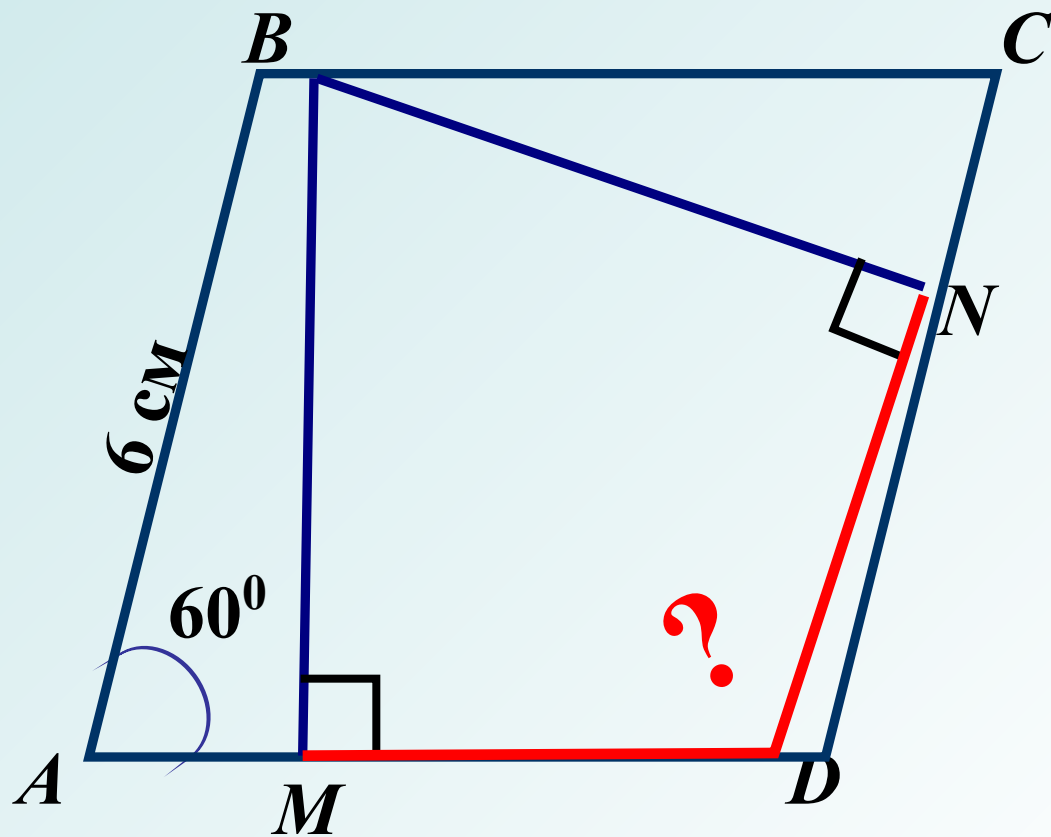

33.

Дано: $ABCD$ – діїа

Найти: $\angle \tilde{N}BA$

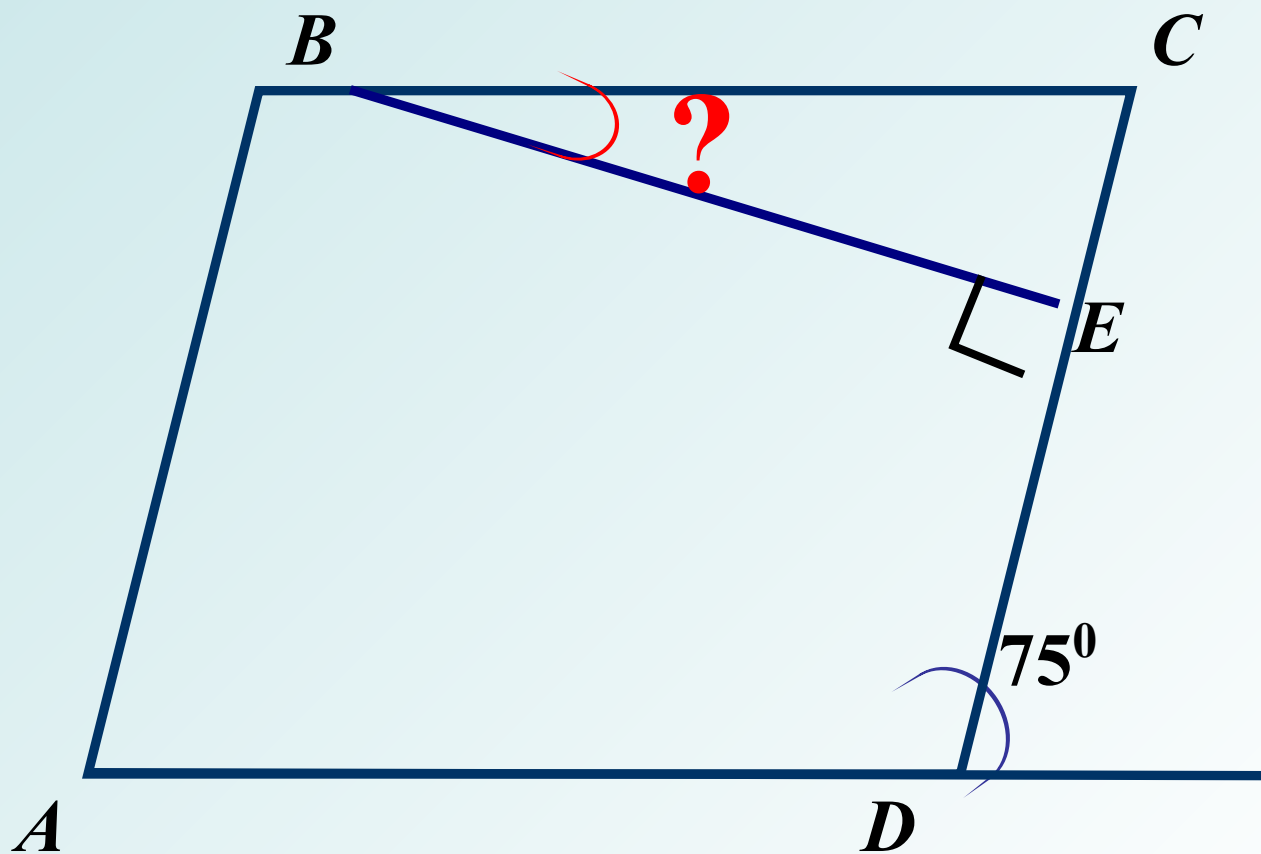

34.

Дано: $ABCD$ – δία

Найти: $\angle BAD$

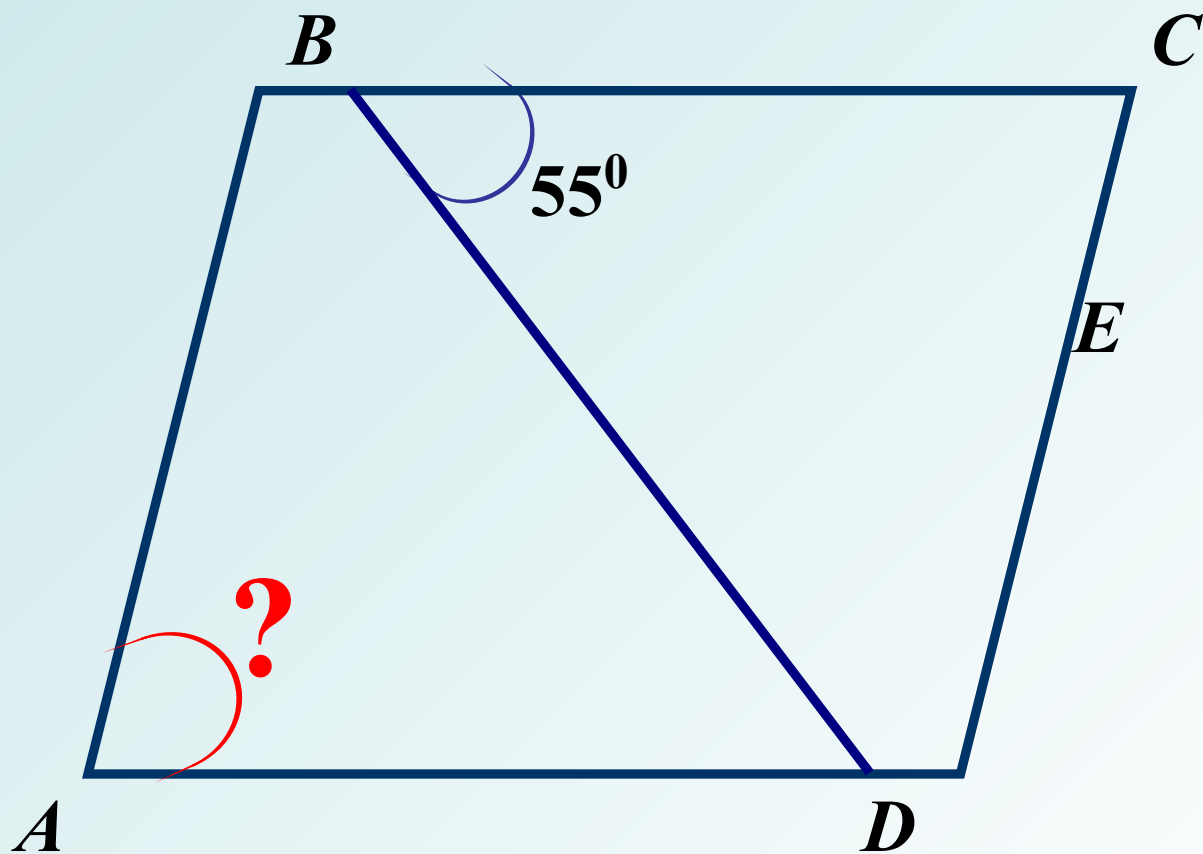

35.

Дано: $ABCD$ – діа́

Найти: $\angle ABC$

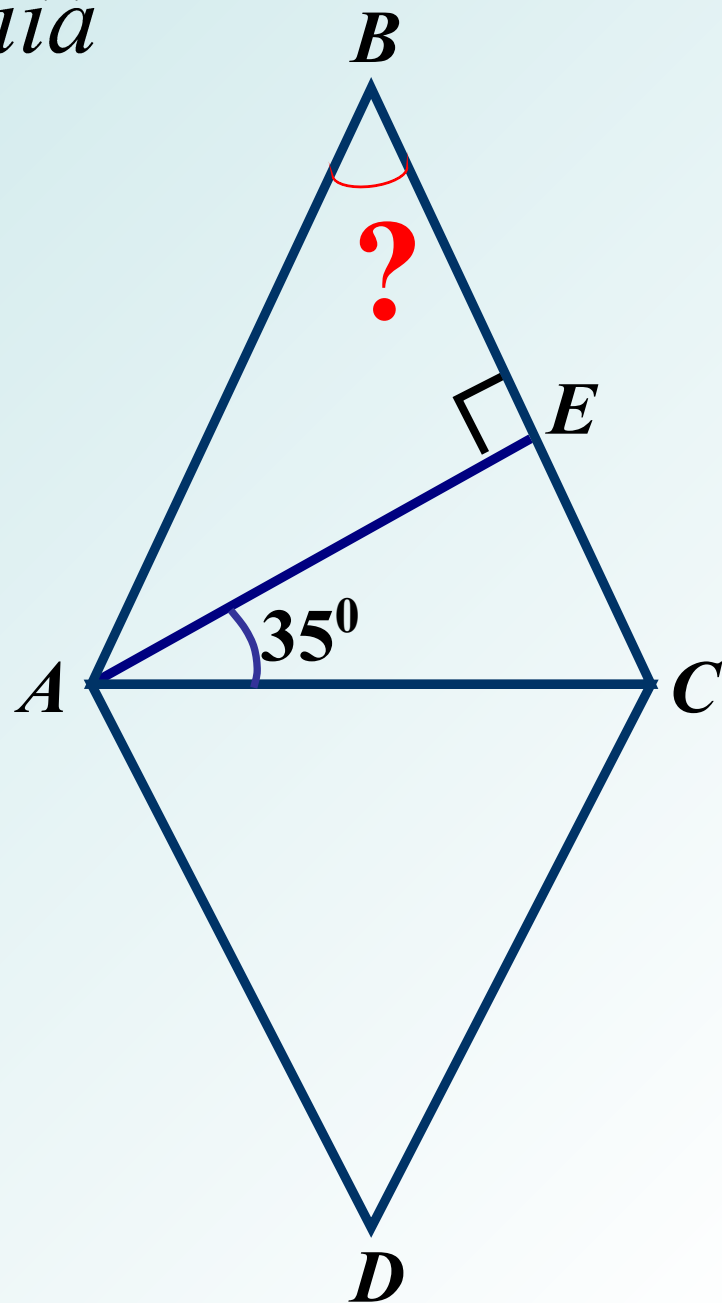

36.

Дано:

$ABCD$ – квадрат

$$DE = 2\sqrt{3}, AE = \sqrt{3}$$

Найти:

P_{ABCD}

