

Process, Power and Marine Division

SmartPlant 3D Common Task



Agenda

- SmartPlant 3D Introduction
- Templates/Session Files
- Filters (Database query)
- Views
- Common Toolbar
- Selecting Objects
- Surface Style Rules
- WBS Items
- Common Toolbar

Agenda Cont'

- Space management
- Inserting Reference Files
- Placing Control Points
- Interference Detection

SP3D Intro: Database Architecture

Report Database set

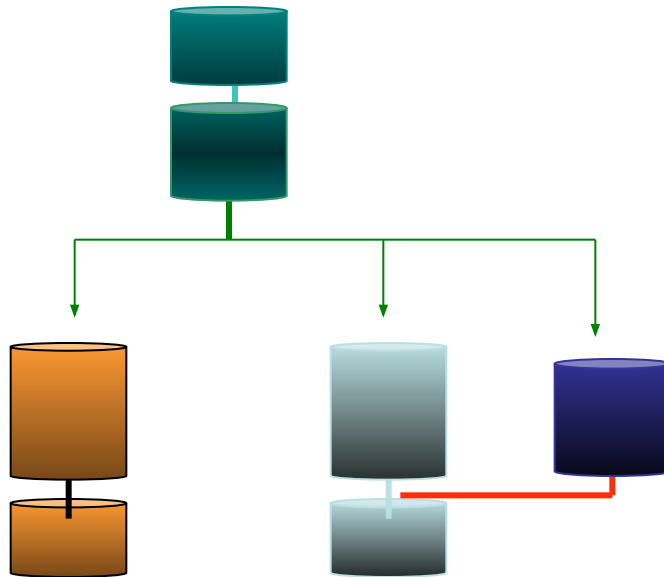

Site Database set *Catalog Database set*
Model Database

Site Database:

Contains names of plants and catalog, model and report databases associated with them.

Catalog Database:

Contains the reference data that is used by all disciplines.

Model Database: Contains design information

Report Database : Collection of views on the plant, site and catalog.

SP3D Intro: Single Database Set

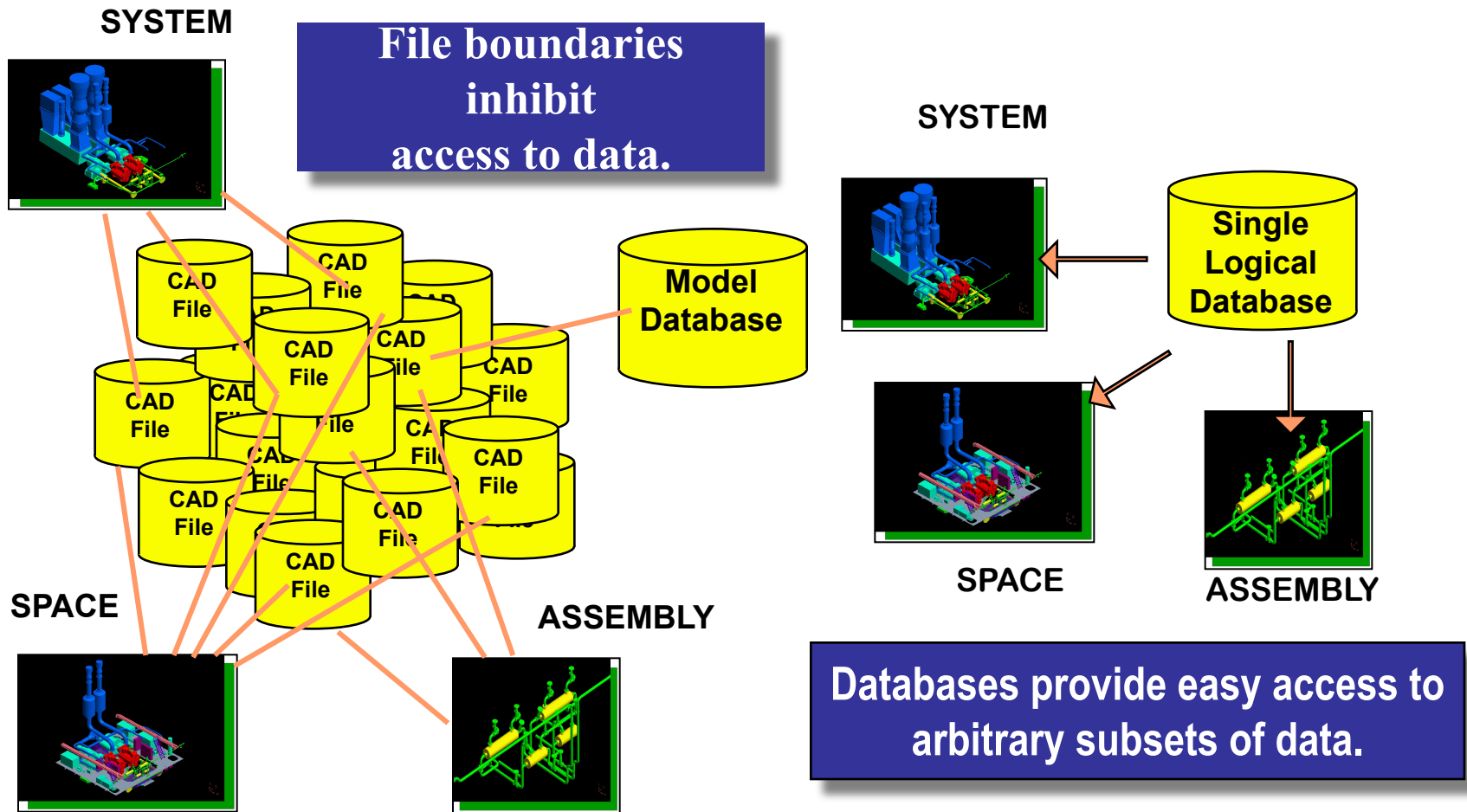

SP3D Intro: Database Query

- Define Workspace (filter on database):
- See only the data you want to see
- Builds a logical “Working Set”
 - System
 - Assembly
 - Spatial (Volume or Planes)
 - Logical Permission Group
 - Object Types/Properties
- Saved Session Files

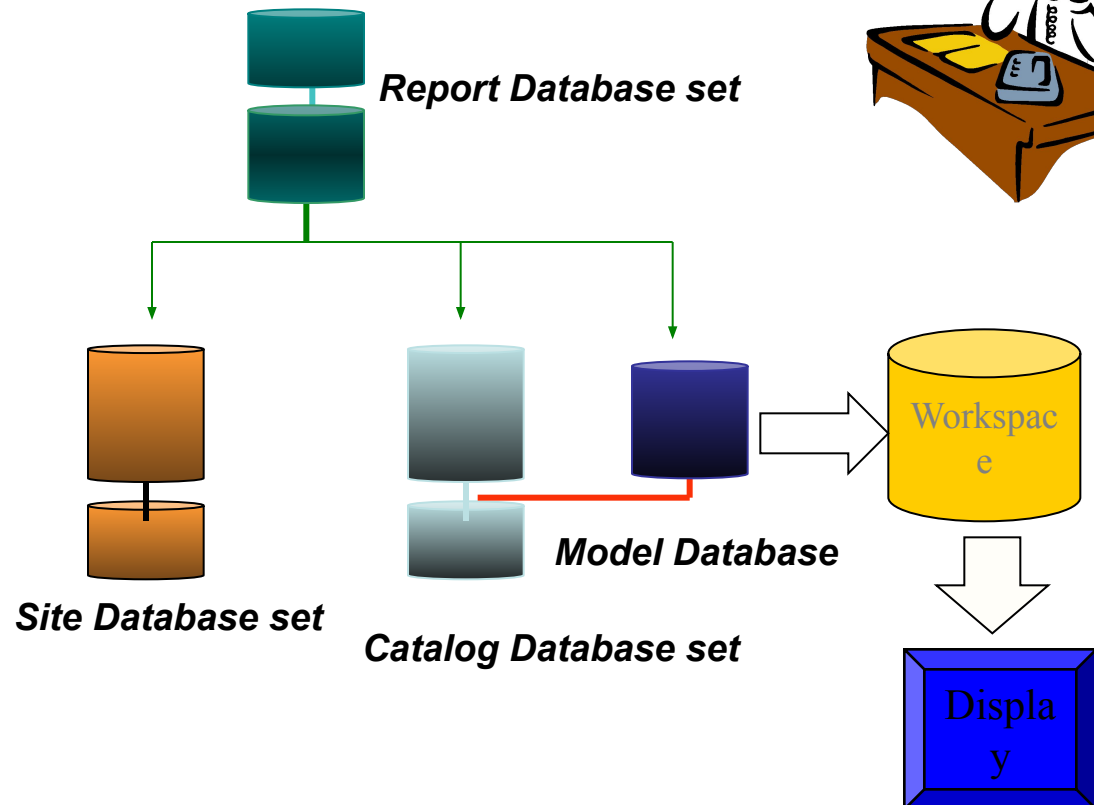

SP3D Intro: Database Architecture

Multiple Plants can rely upon the same Catalog.

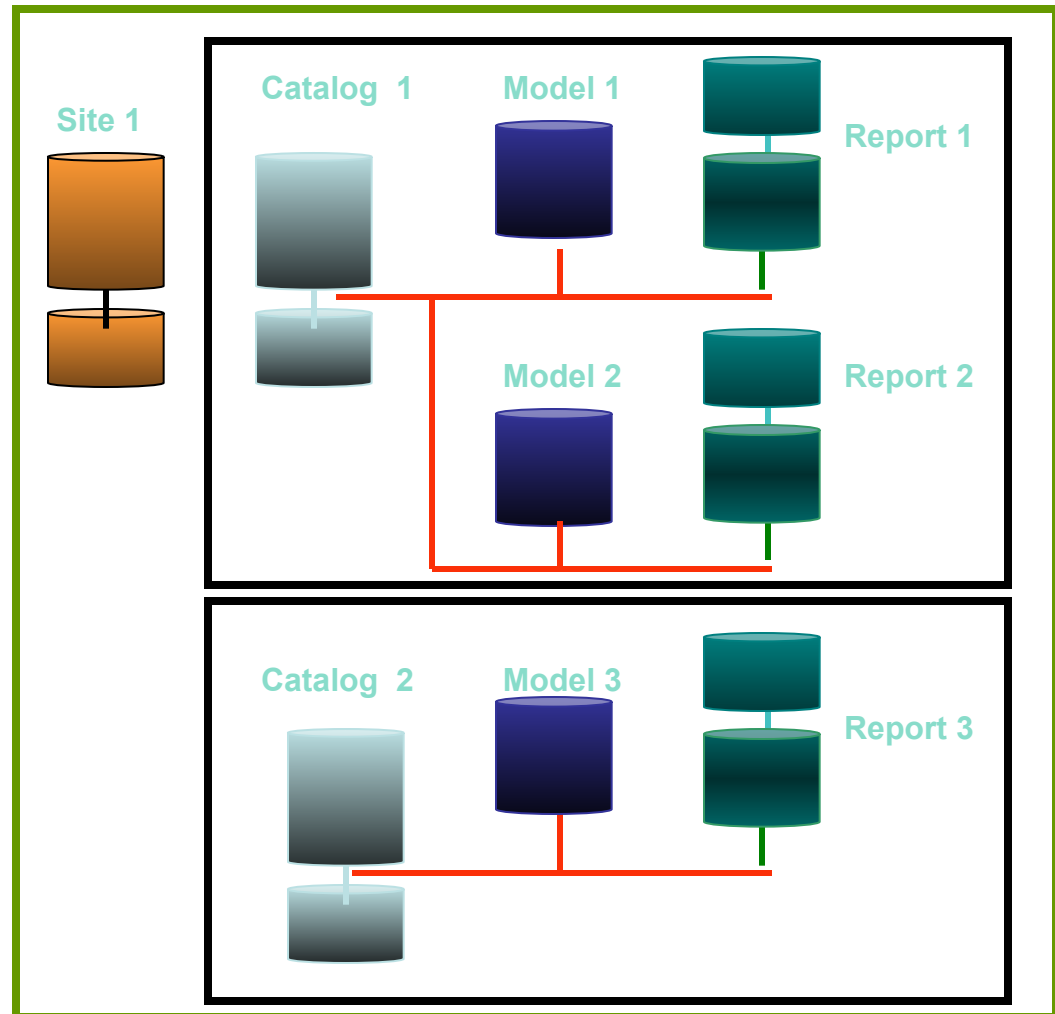

SP3D Intro: Common Windows Based User Interface

- SmartPlant “Task” Oriented Interface
- Common Windows Interface
- Ribbon Bars
- Graphic Views

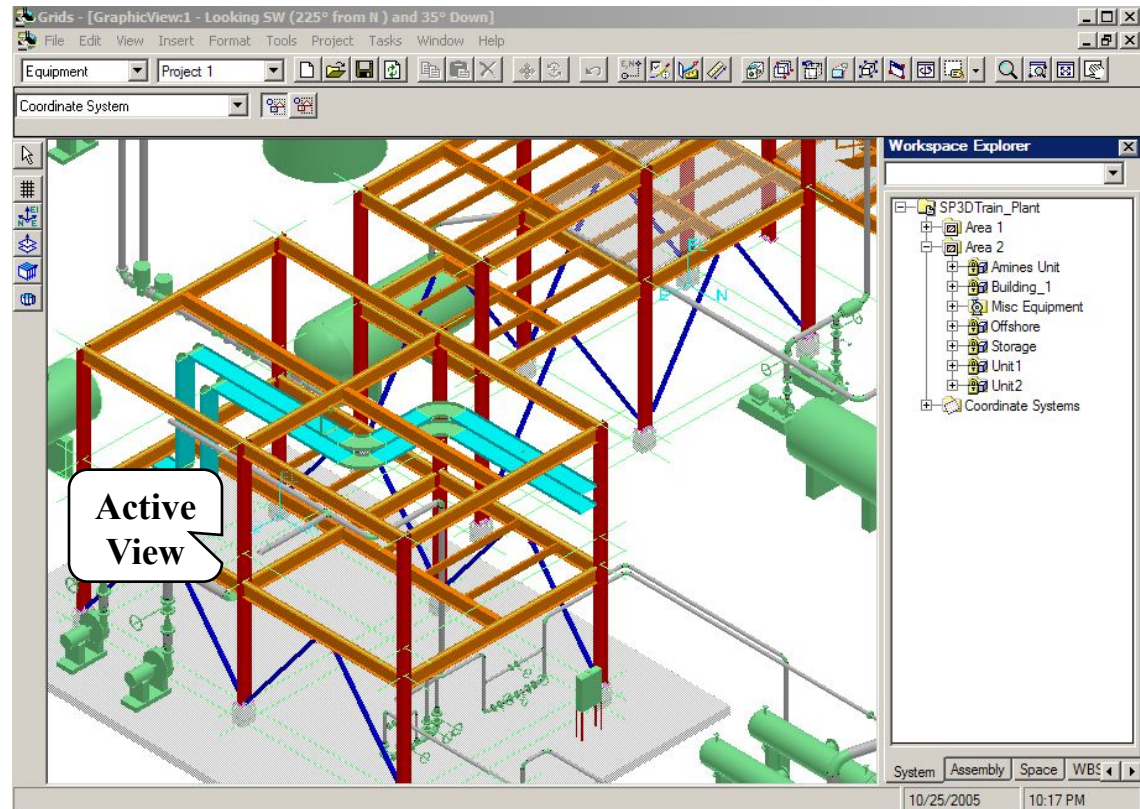
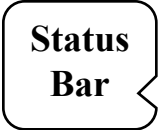
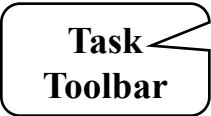
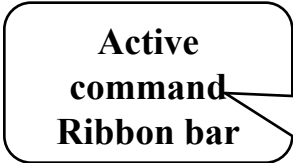
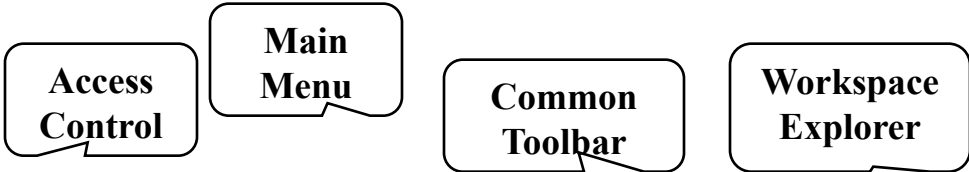

Templates: New Session Templates

Whenever you create a new session, you are working with templates. In this context, a template is a standard workspace file that a user has placed in the templates folder; you use a template as a pattern to assemble the parameters you want for a new work session.

New Session Templates

- Store option settings
- Store Tasks Lists Settings
- Views
- Background colors
- And more

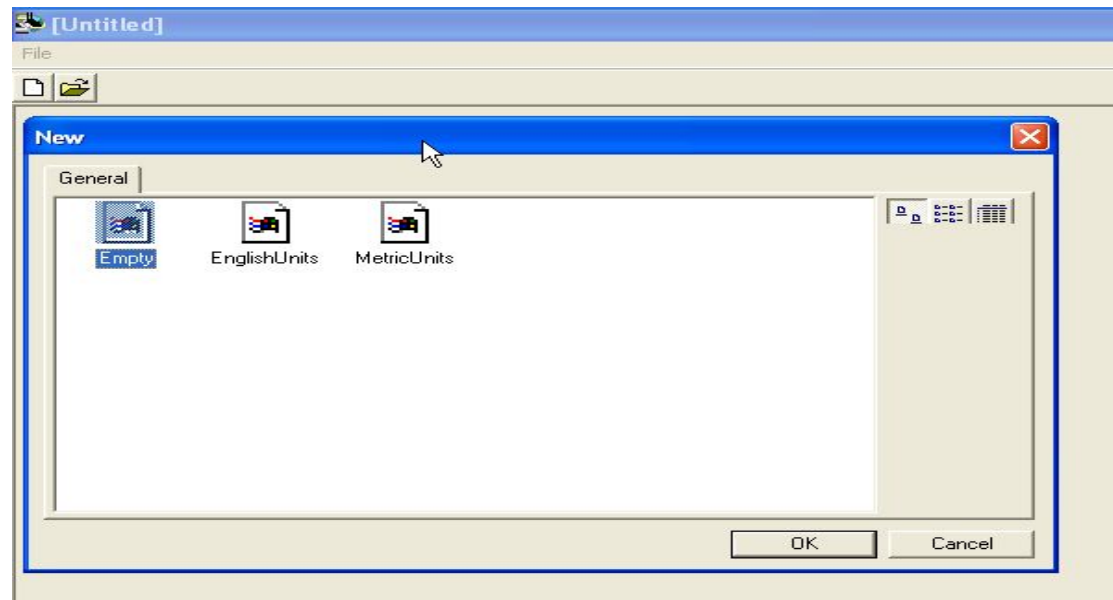

Templates: Session Files

When the save command  is selected while in the SmartPlant 3D interface a dialog box will prompt immediately asking for the desired path for the .ses file:

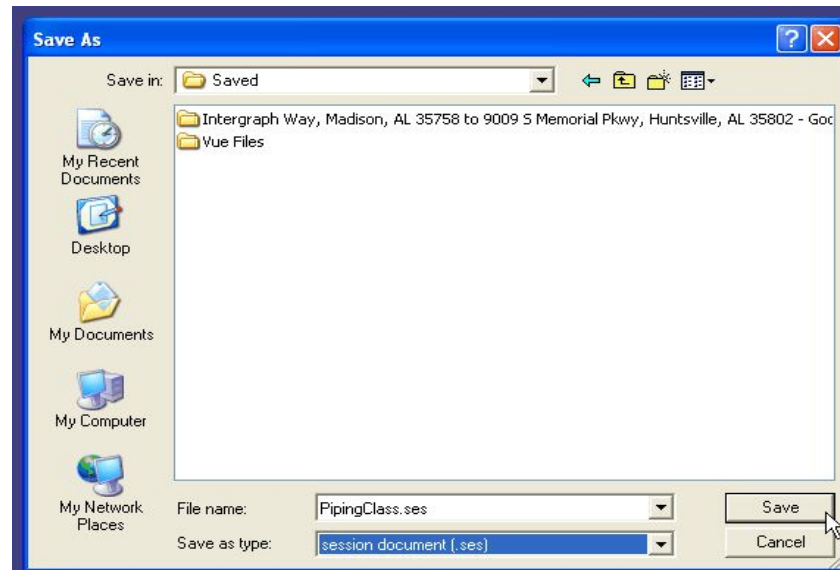

Templates: Session Files cont'

Once the .ses file path has been specified all of the 3D model data displayed in the model workspace as well as options task list and graphical views will be stored in a session file.

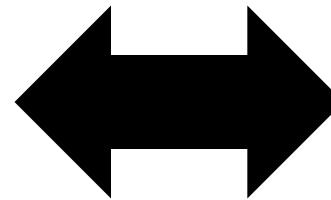
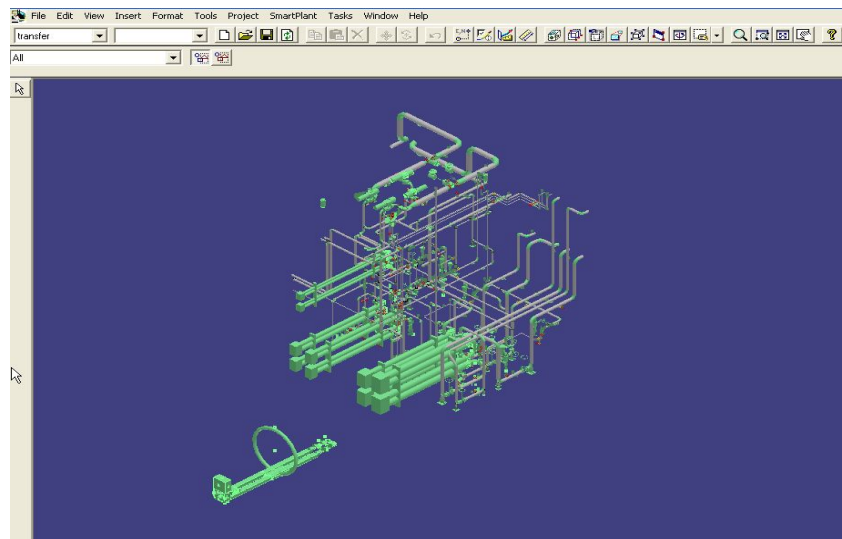

Pipe Class.ses

SmartPlant 3D Interface

- Define Workspace Command - (Ctrl +W)

Select the model
database



Select or create
new filter

Filters

A filter is a set of search criteria that selects or retrieves data based on the object properties:

- System
- Assembly
- Named Space
- Work Breakdown Structure (WBS)
- Analysis
- Permission group
- Object Type
- Spatial (Volume)
- Reference
- Properties
- PDS (If PDS project attached)

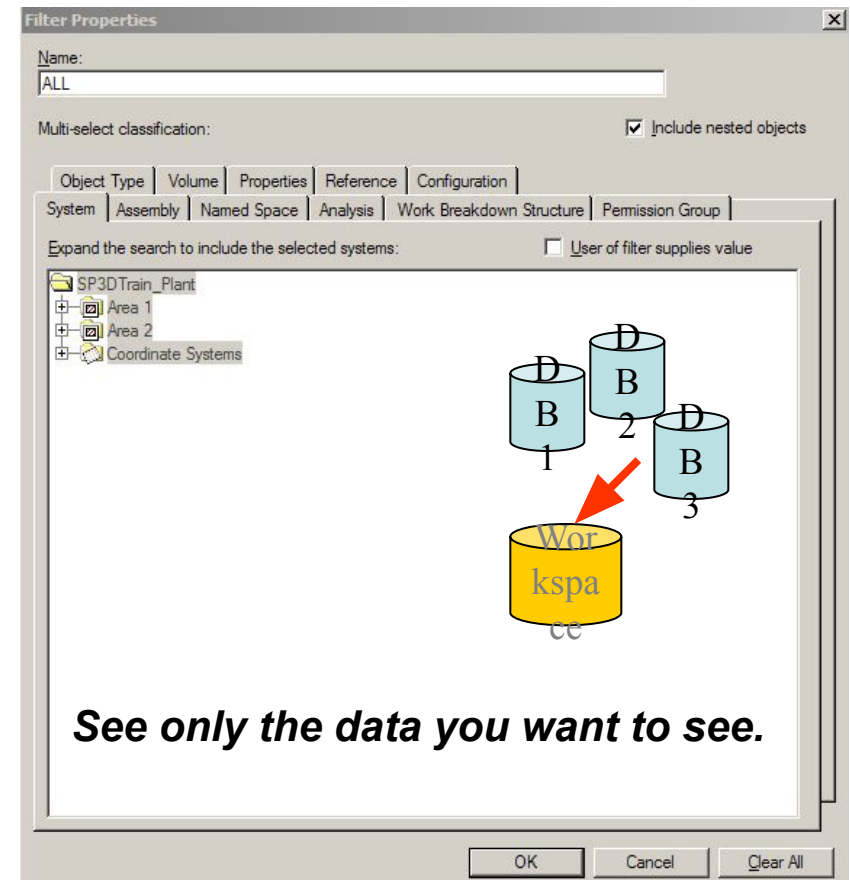

Filters

- Catalog Filters are filters which are stored in the catalog and are available to all users that use the same catalog
- Plant Filters are filters available to all users in a model. These filters are stored in the model database
- My Filters are created by the user and are only visible to him. These filters are stored in the model database

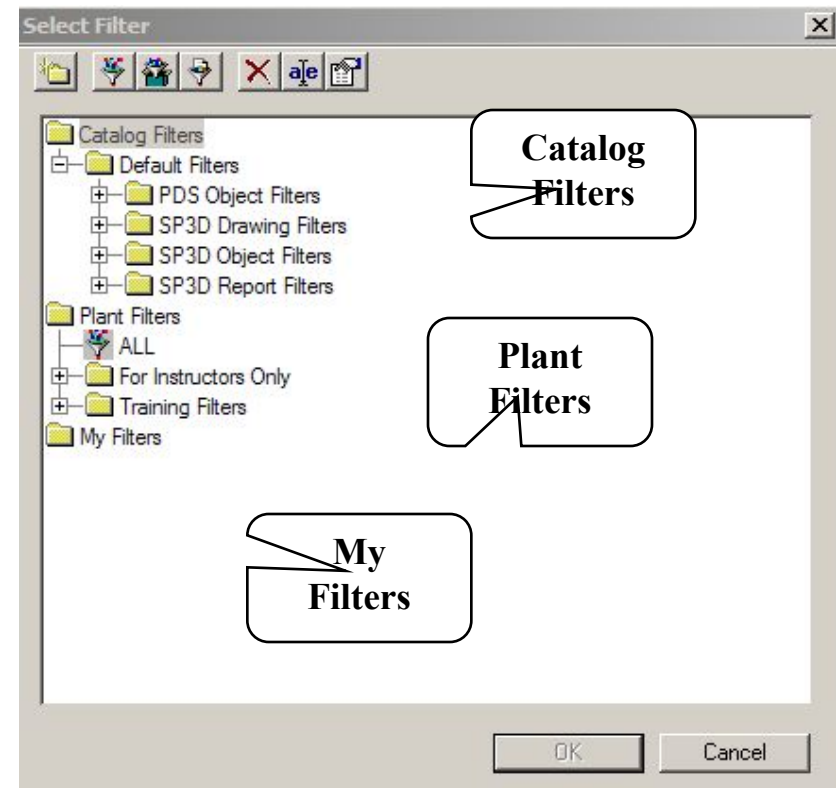

Filters

Simple
Filter

Compound
Filter

SQL
Filter

Simple Filters

Simple Filter is a query based on the object properties defined through GUI

Compound Filters

A “Compound” filter is two or more filters with an operator between them.

SQL Filters

Is a filter which provides a place to store user-written SQL query

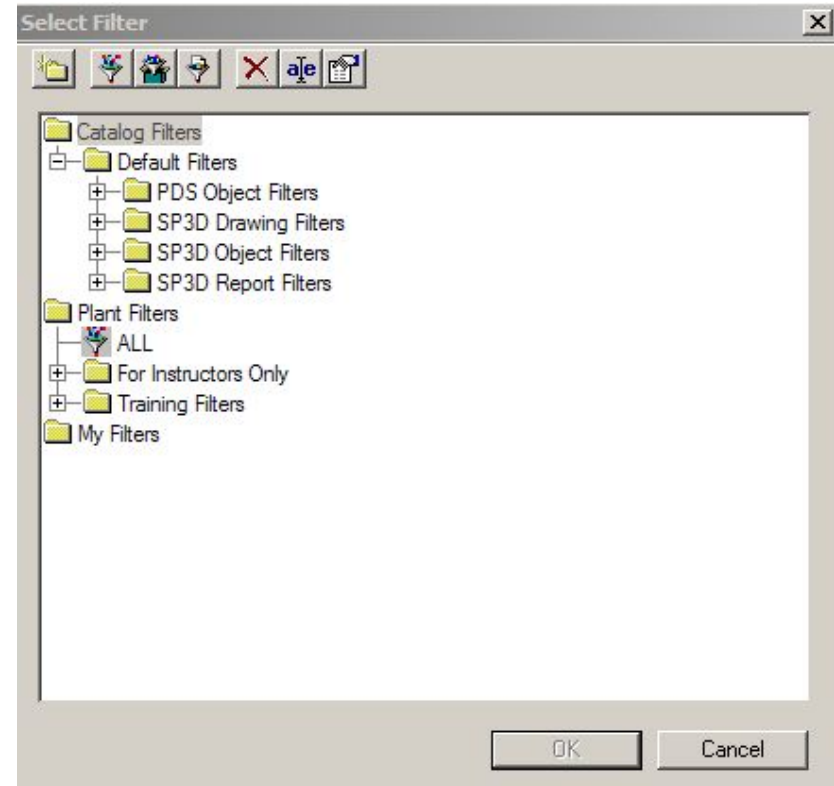

Filters

- New Folder
- New Filter (Simple or Asking)
- New Compound Filter
- New SQL Filter
- Delete
- Rename
- Properties

Folder

Delete

Rename

Properties

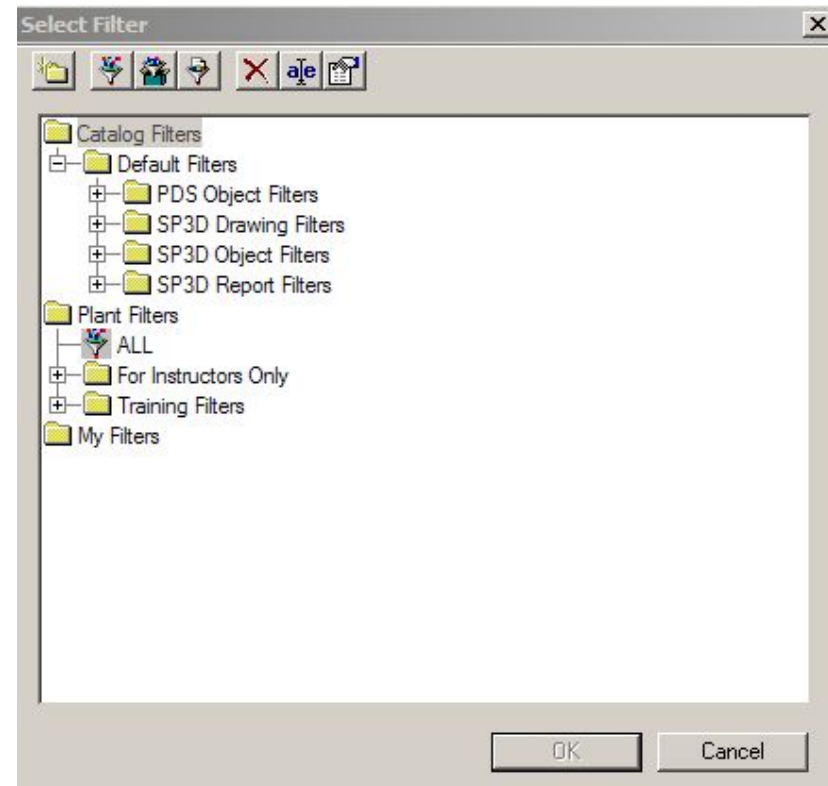

Filter Properties

System Tab

Expand the search to include all selected systems

- A system is a way to group objects logically
 - e.g. by discipline, by design area, by physical area, etc
- Every object must belong to a system
- System Types

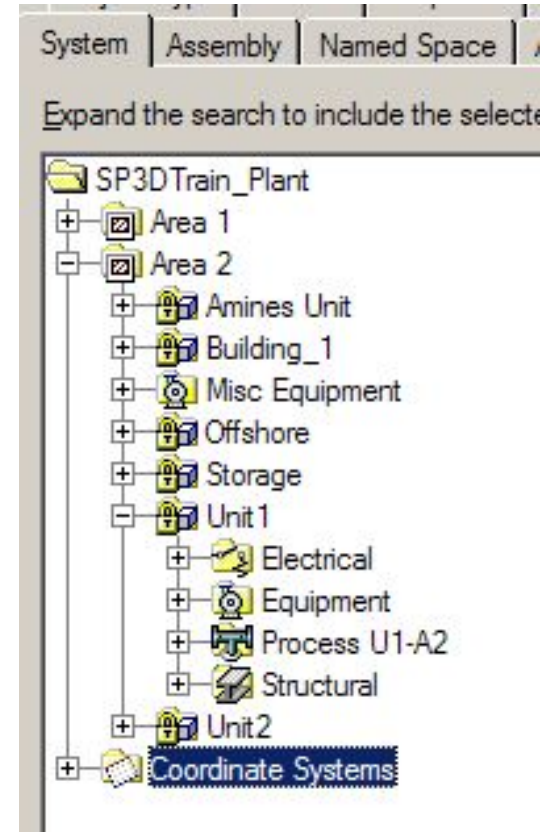

Filter Properties

Volume Tab

Restrict the search to return only objects within the volume

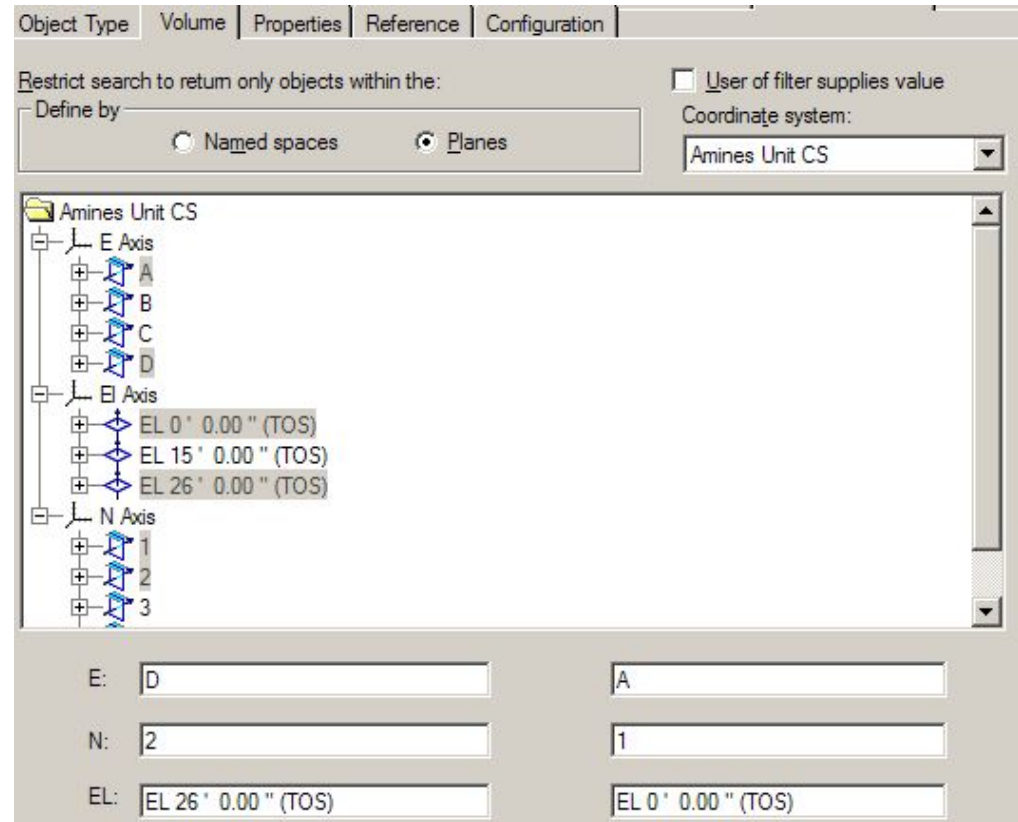
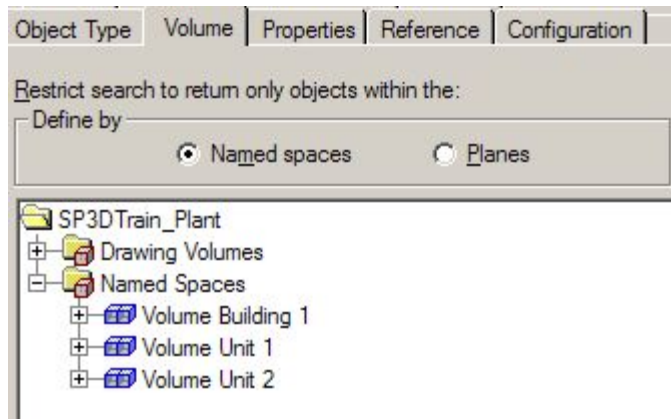

Filter Properties

Object Class Tab

Restrict the search to return only objects of the selected types

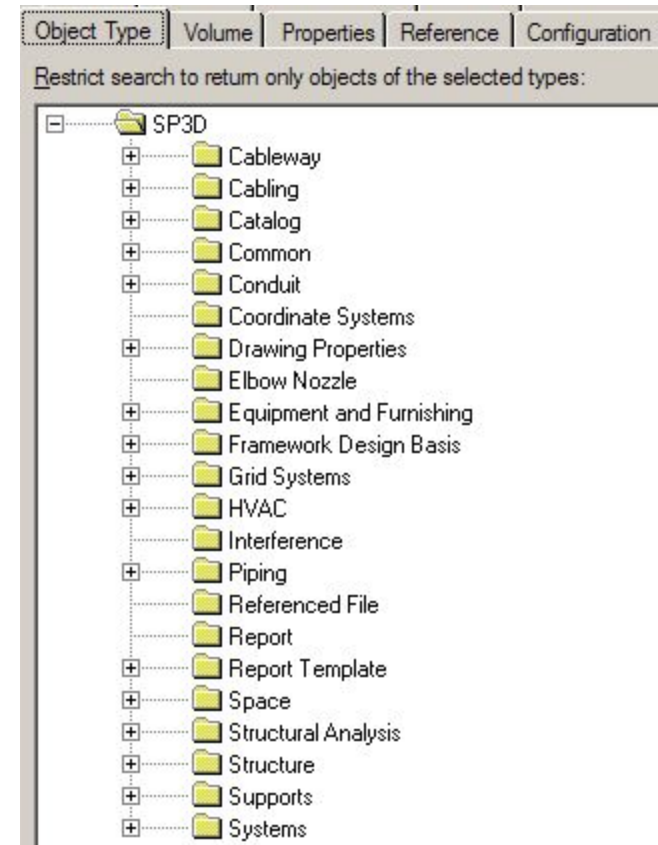

Session Templates & Filter

Session Template + Filter = Workspace/Session File

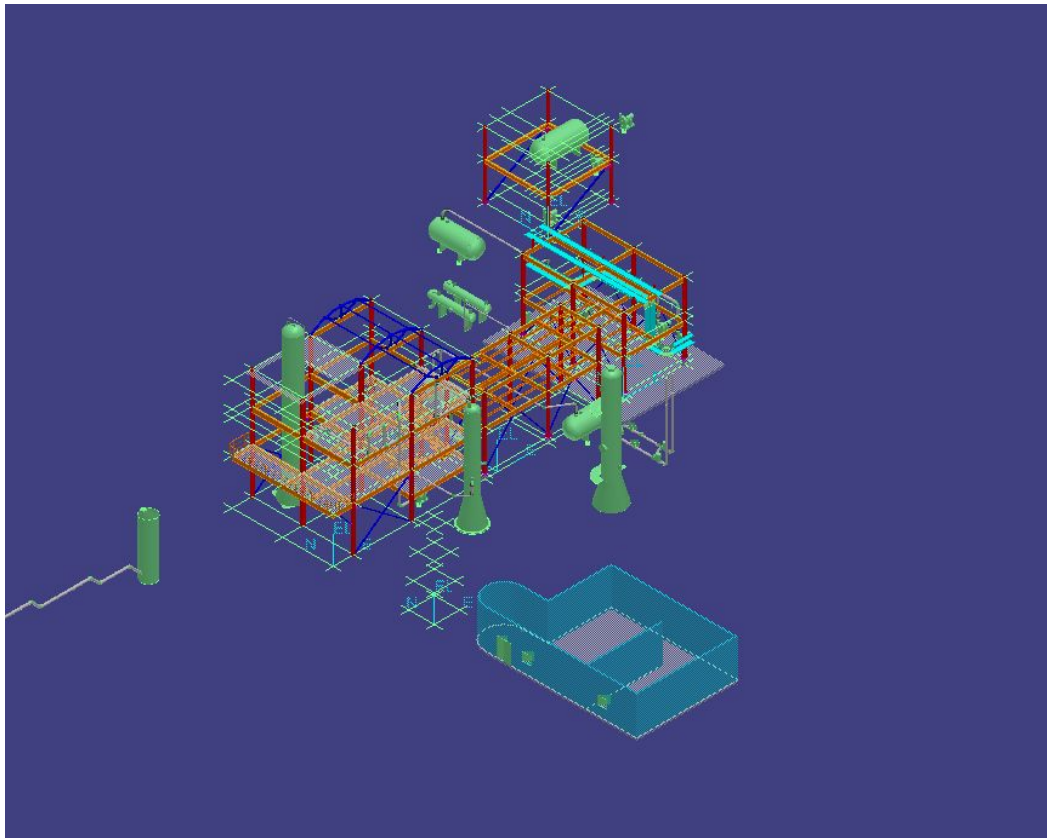

SP3D Practice Labs

- Creating a Session File
- Defining a Workspace by a System Filter
- Defining a Workspace by a Volume Filter

View Manipulation

Common Environment Toolbar

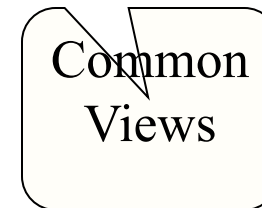
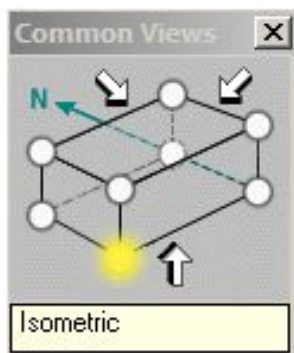

Common views command allow you quickly change the view orientation to any standard isometric/orthogonal orientation

View Manipulation

Common Environment Toolbar



Zoom
Tool

Zoom
Area

Pan

Zoom Tool command:

- Zoom in (mouse roller ball)
- Zoom out (mouse roller ball)
- Zoom Area (left mouse click, drag and release)
- Pan (middle mouse drag)

View Manipulation

Common Environment Toolbar



Fit View command:

Fit all visible objects within the current clipping volume in the Active View

If objects are selected, then the command will fit only the selected objects

Fit

View Manipulation

Common Environment Toolbar



Refresh command:

Update your workspace definition (filter) in the Active View

View Manipulation

Common Environment Toolbar

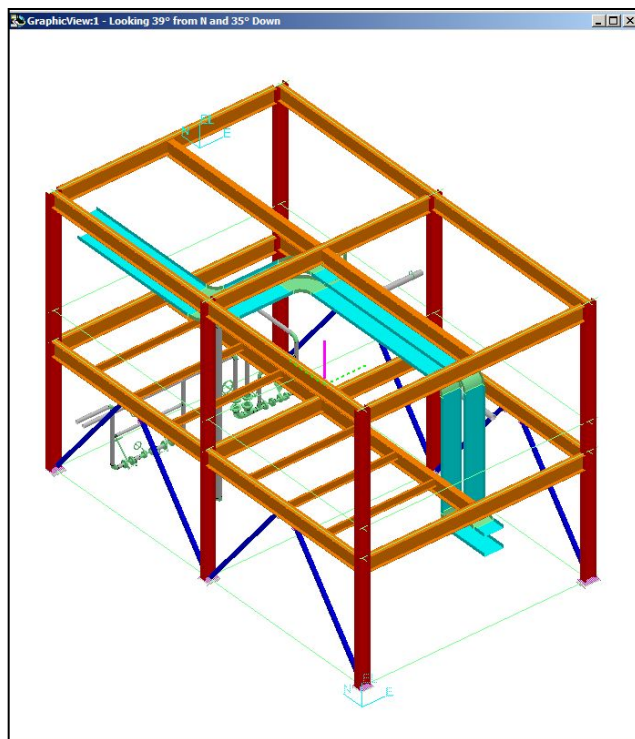

Rotate
View

45.00 deg

Close

Rotate View command:

- Rotate the view interactively
- Change the rotation axis
- Change the rotation point

View Manipulation

Look at Surface command:

- Rotate the active view planar to the selected surface

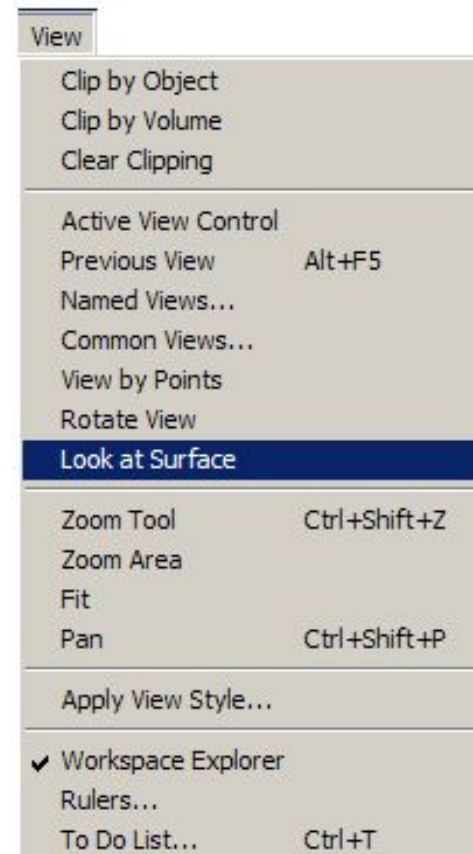

View Manipulation

Establishing Clipping Volume

- Clipping by Object
- Clipping by Volume
- Clear Clipping

View Manipulation

Common Environment Toolbar



Clip by
Object

Clip by Object command:

Allows you to define the view clipping volume (rectangular parallopiped) to be the same as the object's range box in your active view

View Manipulation

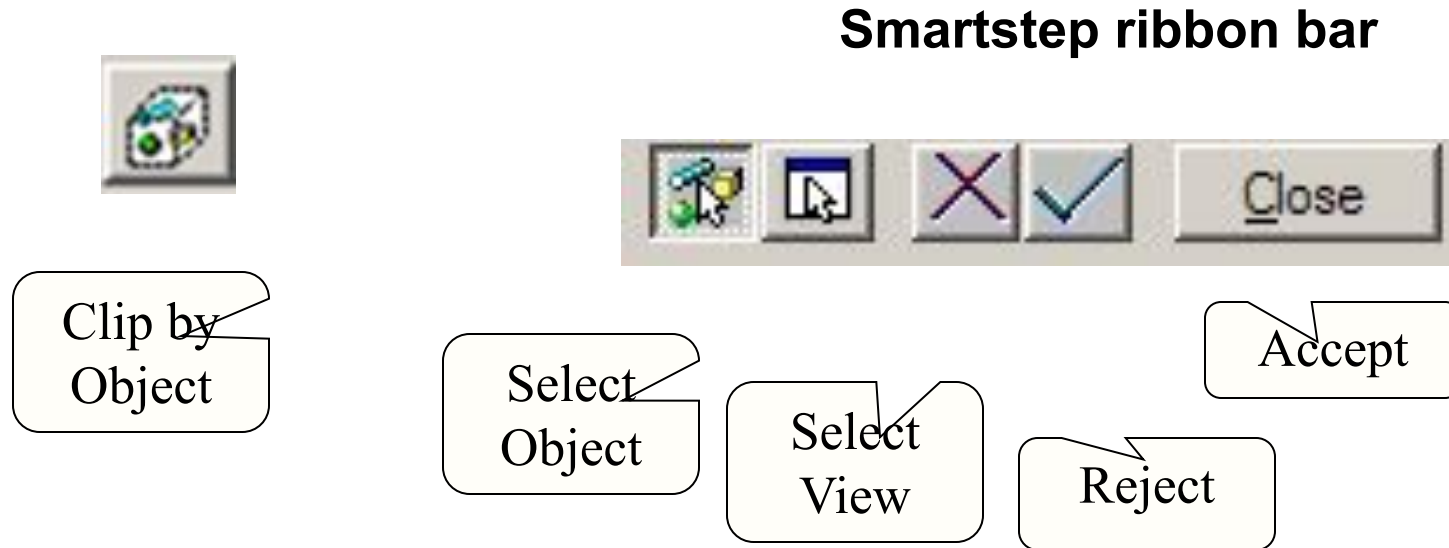

A command step is also provided to assign the same clipping volume to additional views

Use the Shift key to select multiple objects

View Manipulation

Common Environment Toolbar



Clip by Volume command:

Allows you to set the view clipping volume so that all objects not inside the clipped area are hidden from the selected view

View Manipulation



Smartstep ribbon bar

Select
View

Drag
Clipping
planes

Clip by
Volume



First
point

Second
point

Third
point

Four
point

View Manipulation

Common Environment Toolbar



Clear Clipping command:

Remove the clipping volume.

It then prompts for select of the next window to clear

The command is terminated by:

- Right mouse click
- Esc Key
- Pick of another command

View Manipulation

Restore the Previous View

Main Menu

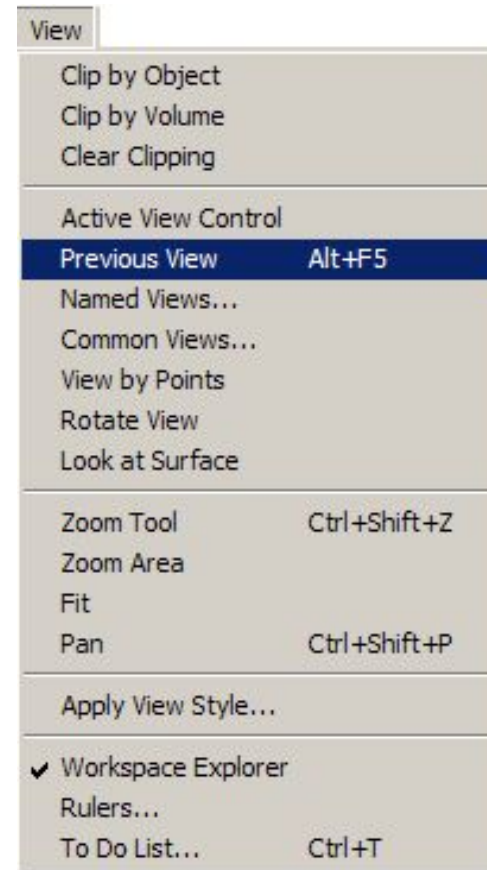

View Manipulation

Common Environment Toolbar

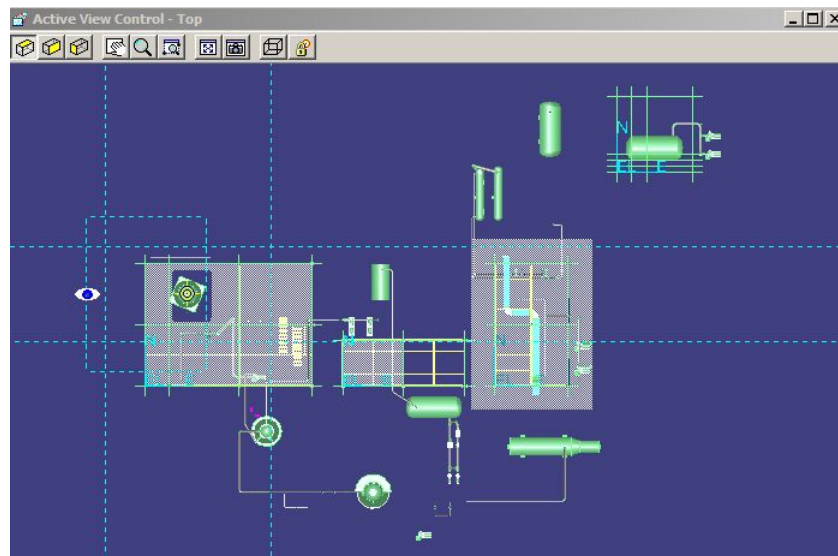

Active View
Control

Active View control command:

Provides commands to dynamically control the view parameters of the active view

View Manipulation

Common Environment Toolbar



Named
View

Recall
Views

Saved View (Named View) command

You can save the settings (location, orientation) of the active view so that you can apply them again later

Recall views from the pull down on the command, four standard views supplied.

View Manipulation



Common Environment Toolbar



View by
3 pts

View along
line

View by
pts

View by 3 Points

- Let you pick 3 Points that define a plane
- The plane of your screen is the plane defined above (pt3 will be located the center of the view plane)

View along line

- Lets you pick the two points along a line.
- The plane of your screen is the plane perpendicular to above line

Measure



Tool -> Measure

Measure Actual or Minimum 3D linear distance between two points

Measure delta E, N, EL distance between two points

Measure actual angle defined by three points

Measure radius and diameters

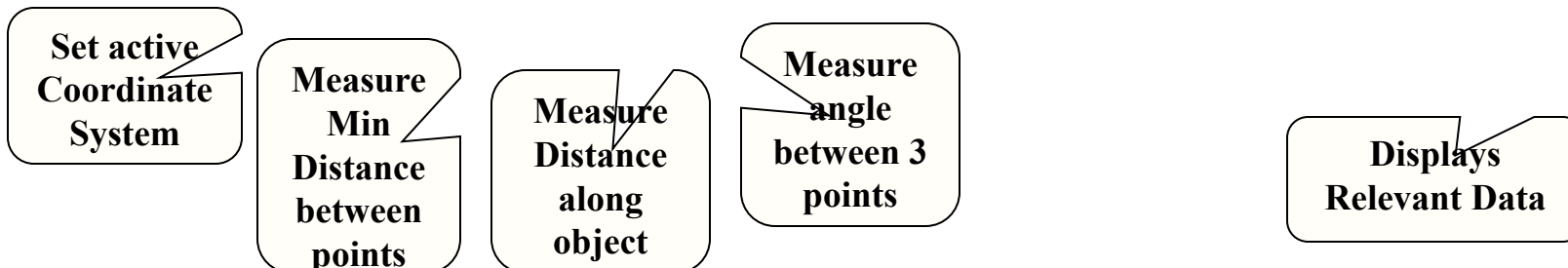
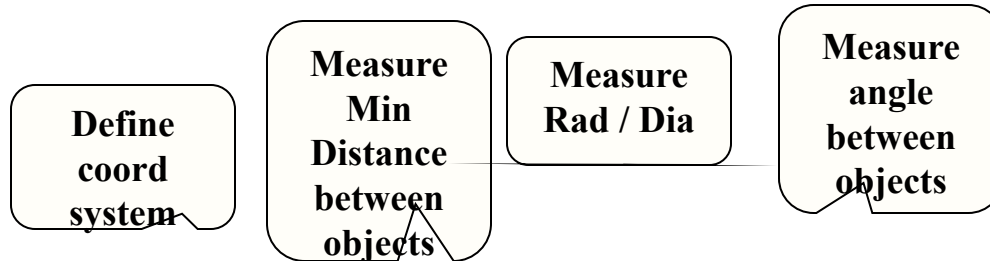

SmartSketch

SmartSketch is the mechanism to automatically find special points when the command is looking for a point.

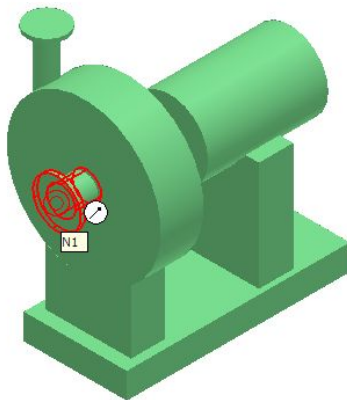

Parallel			
Perpendicular			
Angle			
Reference axis aligned			
Point on Surfaces			
Offset			
Intersection			
Divisor			
Point on curves			
Key point			
Add to stack			

SmartSketch Options

- Allows you to enable the SmartSketch indicators

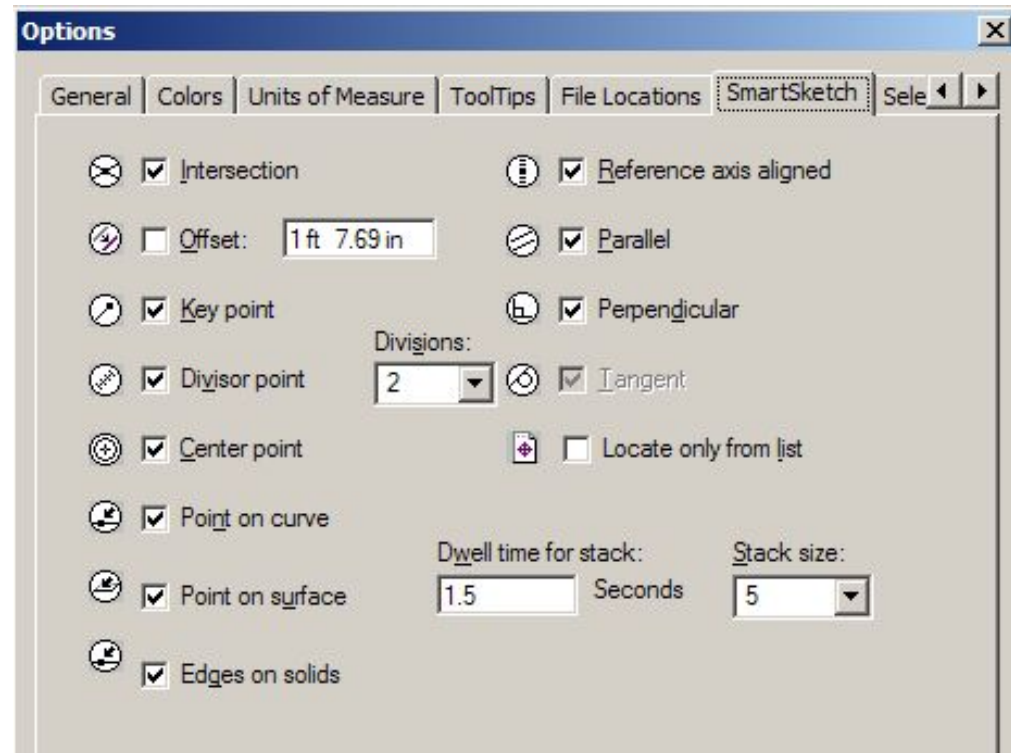
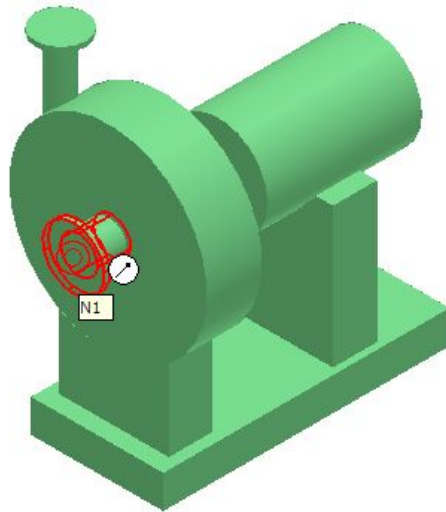

SmartSketch

The system finds Key point and Point on Geometry whenever you move the cursor over those points

System uses only those points (stored in the stack) and check for linear relationship points against every object in the workspace



SmartSketch

User will have two options on what objects are located by SmartSketch

- Locate on Display List
- Locate on List Only

SmartSketch Lock Constraint

When SmartSketch is being used, a middle mouse click will lock the currently active smartsketch constraint.

- **Middle mouse button (VERY USEFUL TOOL)**
- Ctrl –L keys

SmartSketch

User will have two options on what objects are located by SmartSketch

- Locate on Display List
- Locate on List Only



Clear Stack

Set Stack
Size

Locate List



Toggle
Display/List
Only

Set Dwell
Time

Pinpoint

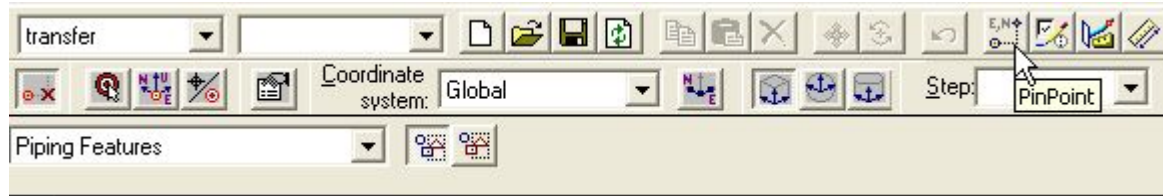

- **PinPoint**

An options for moving or placing objects with precision.







- **Display On/Off (F9)** - Displays or hides the **PinPoint** options and distance values. The shortcut key for this box is F9.
- **Reposition Target** - Changes the location of the target point. The EX- and NY-coordinates are relative to a target point you define in the view. Also, you can reposition the **PinPoint** target by pressing F12.

Common Toolbar

- Common Views
- Zoom Tool
- Window Area
- Refresh View
- Active View Control
- Rotate View
- Looking at Surface
- View by 3 points
- View along line
- Clipping





Common Tools







-  Copy
-  Paste
-  Delete
-  Move
-  Rotate Object
-  Undo

Common Tools Conti'



-  New Session
-  Open Existing Session
-  Save Current Session (.SES file)
-  Refresh Active Workspace

Select Objects

-  Select Command
-  By Fence Inside Control
-  By Fence Overlap Control
- Use shift key to add or remove objects from the select set.
- Tools -> Select by Filter
- Use Workspace Navigator
-  &  Quick Icon and toolbar

Main Menu

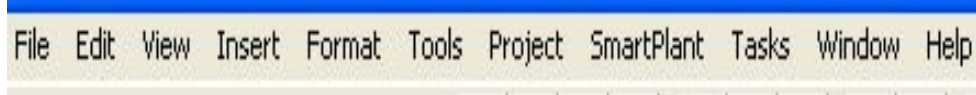
A screenshot of the main menu bar in the SmartPlant 3D software. The menu bar is a horizontal strip with a light beige background and a blue border. It contains the following menu items: File, Edit, View, Insert, Format, Tools, Project, SmartPlant, Tasks, Window, and Help. The text is in a standard sans-serif font, and the 'SmartPlant' item is highlighted with a blue background.

File Edit View Insert Format Tools Project SmartPlant Tasks Window Help

The software's menu bar allows you to access all commands, divided by workflow or task. When you click a command, a description of the command appears in the message field at the bottom left of the main application window. You can also click the **Help** button on the main toolbar, and then click a menu command to view a description of that command.

General Options

- Allows you to enable the Undo command and the status bar
- The activation time of the quick pick tool
- Define the locate zone for SmartSketch
- Define the Tabs to display in the Workspace Explorer

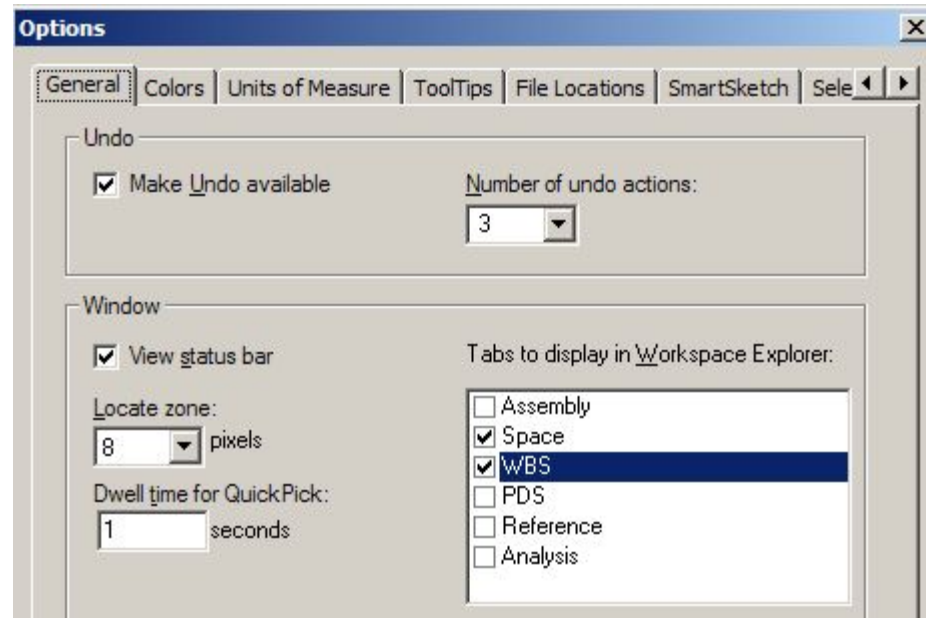
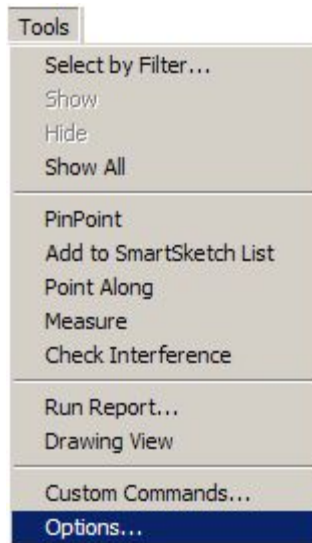

Colors Options

Allows you to select the colors the system uses for the background, Highlight and selected elements

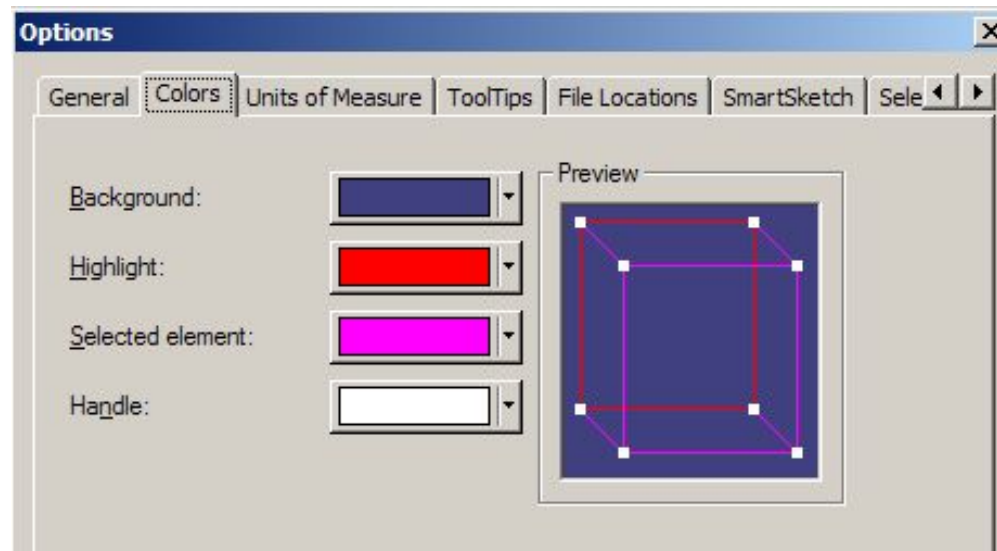

Units of Measure Options

- Sets the display units
- Sets the precision of the units
- Everything stored in SI units in database
- Units can be added to any keyed in input values

Example:

Slope: in / ft

Distance: in (fractional)

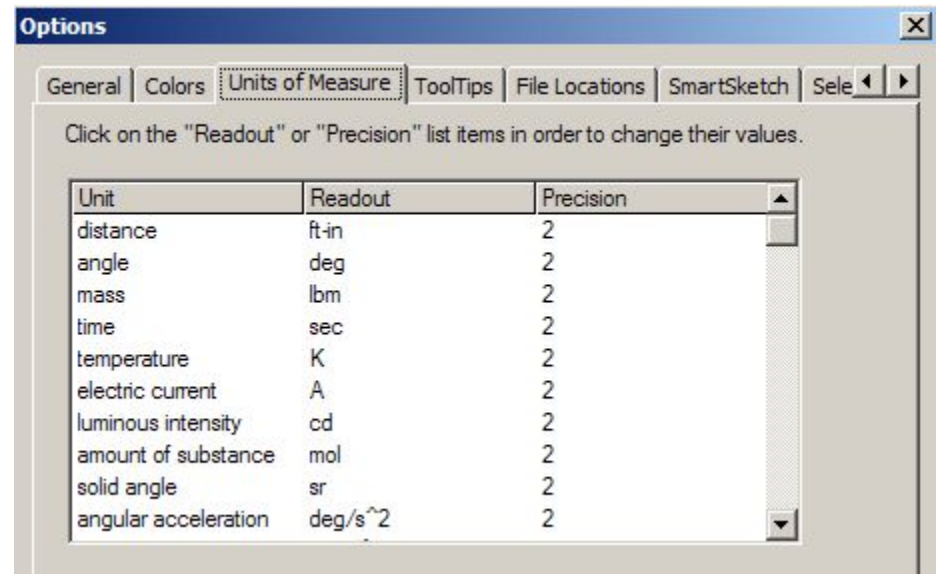

File Locations Options

- File Locations

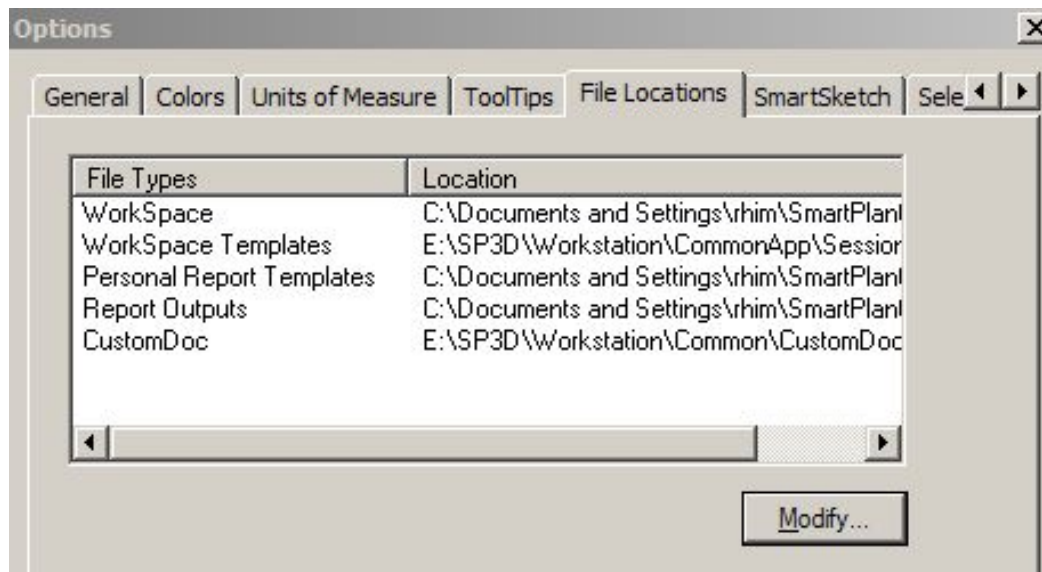

SmartSketch Options

- Allows you to enable the SmartSketch indicators

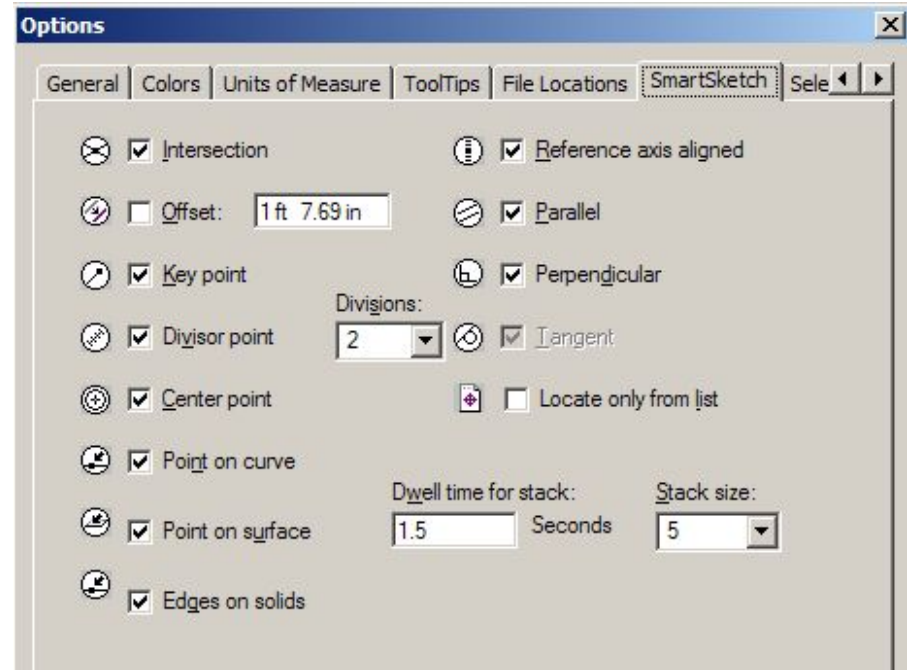
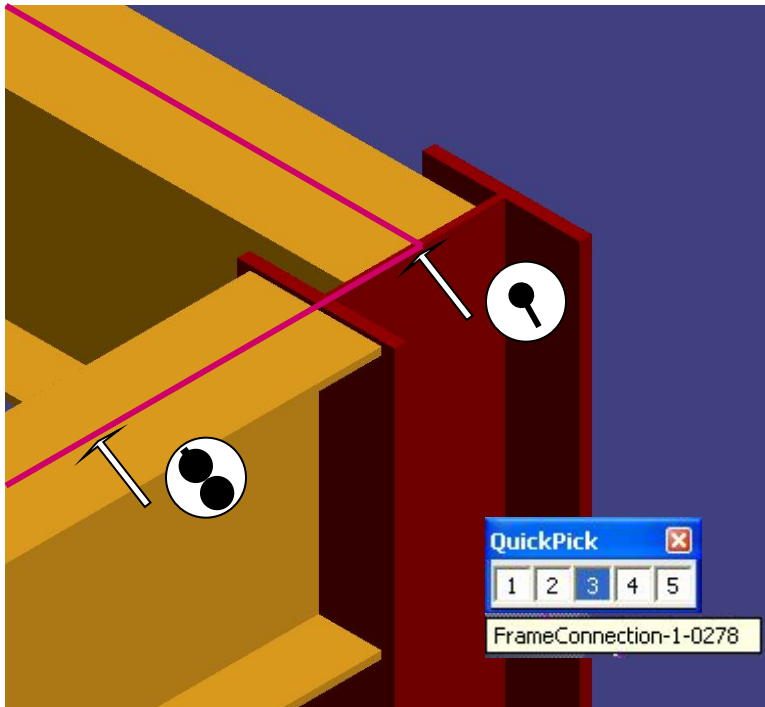

Formatting the Active View

- You can format a View by defining a render mode and perspective setting
- Render mode: Outline, Smooth Shaded and Shaded with Enhanced Edges
- Aspect is a geometric representation for an object

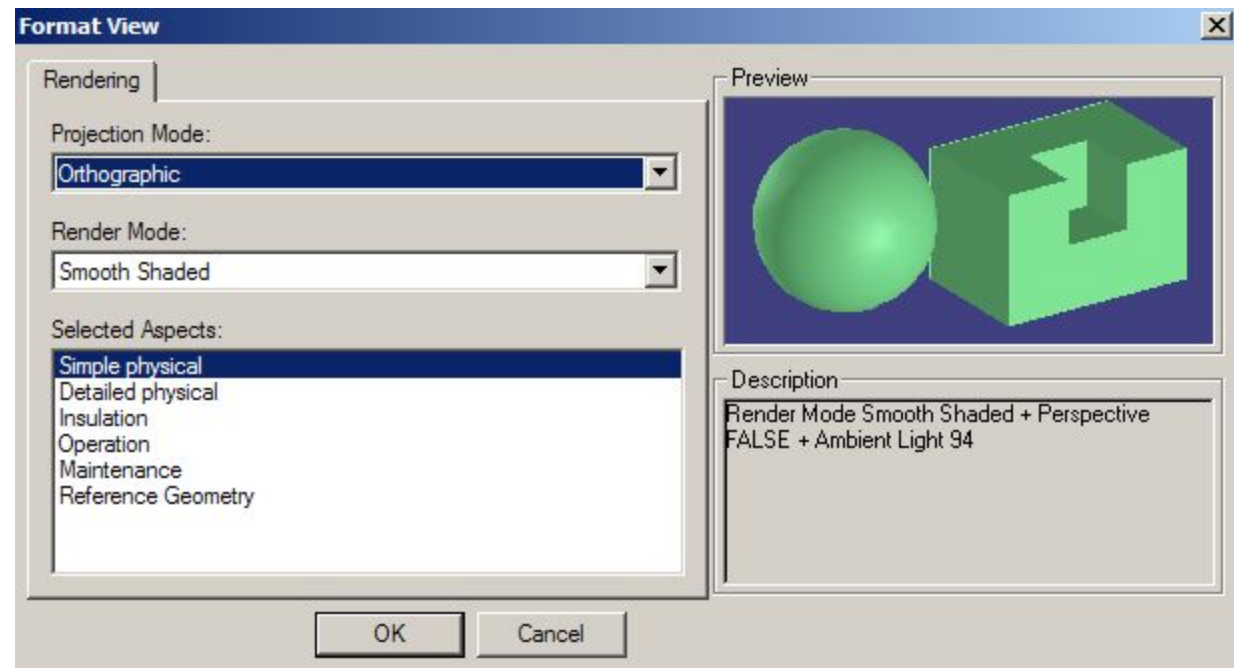
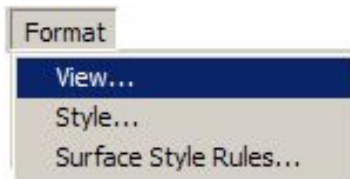

Applying Styles

Styles are collections of color, lighting, and render modes that you can apply to all views or to specific items in the views. New user styles are stored in the database

- View Style
- Surfaces Style

**All Styles
Or
Styles used in
workspaces**

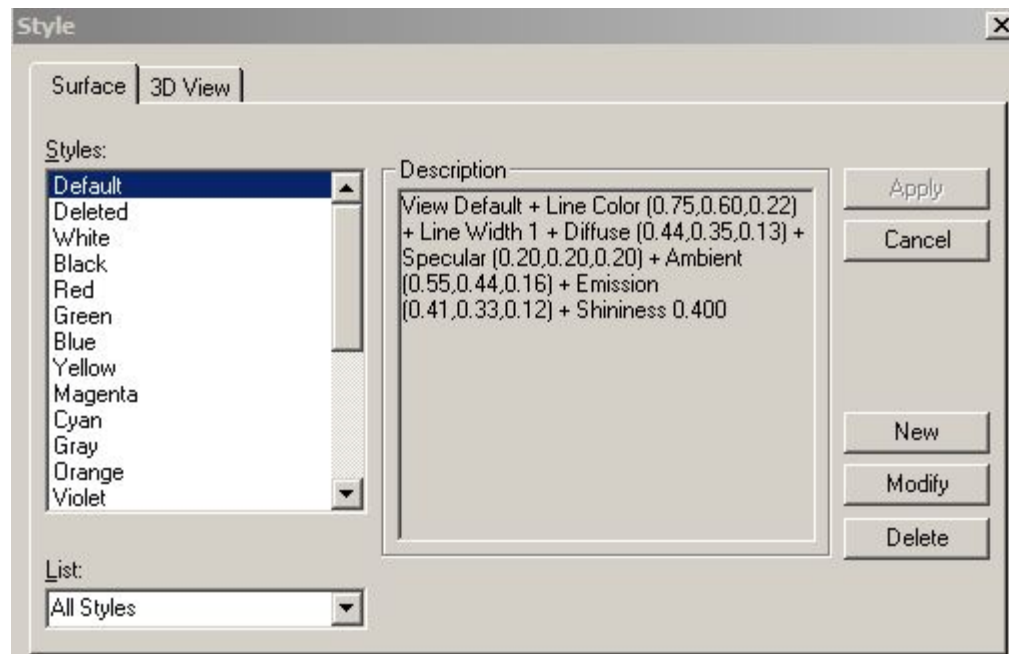

Applying Surface Style

- to Selected objects
- Using surface style rules

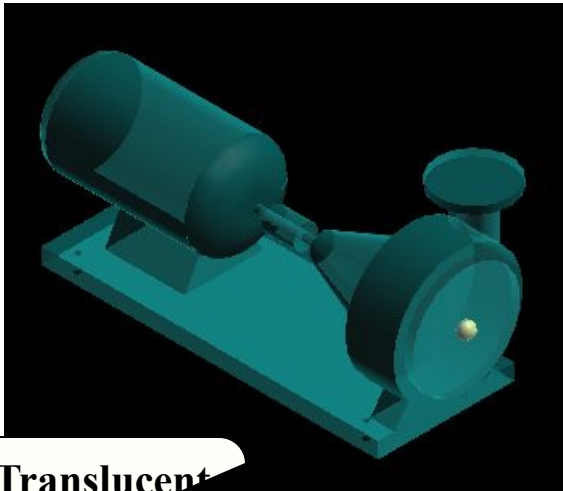

**Translucent
Green**

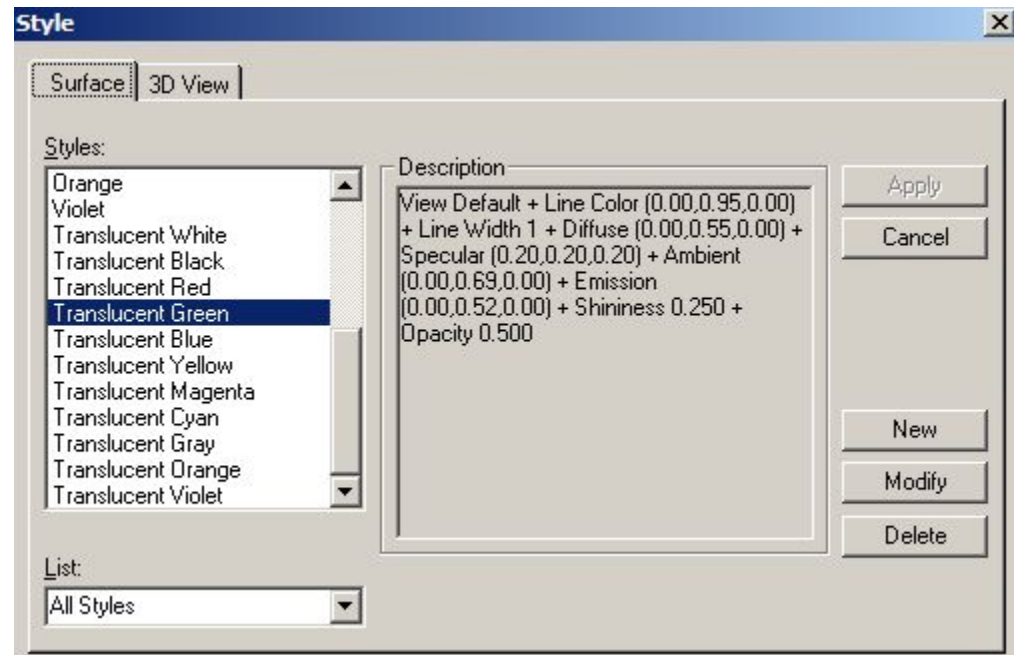

Applying Surface Style

- A Surface Style Rule consists of a filter and the named surface style to be applied to the specific aspects of the objects identified by the filter

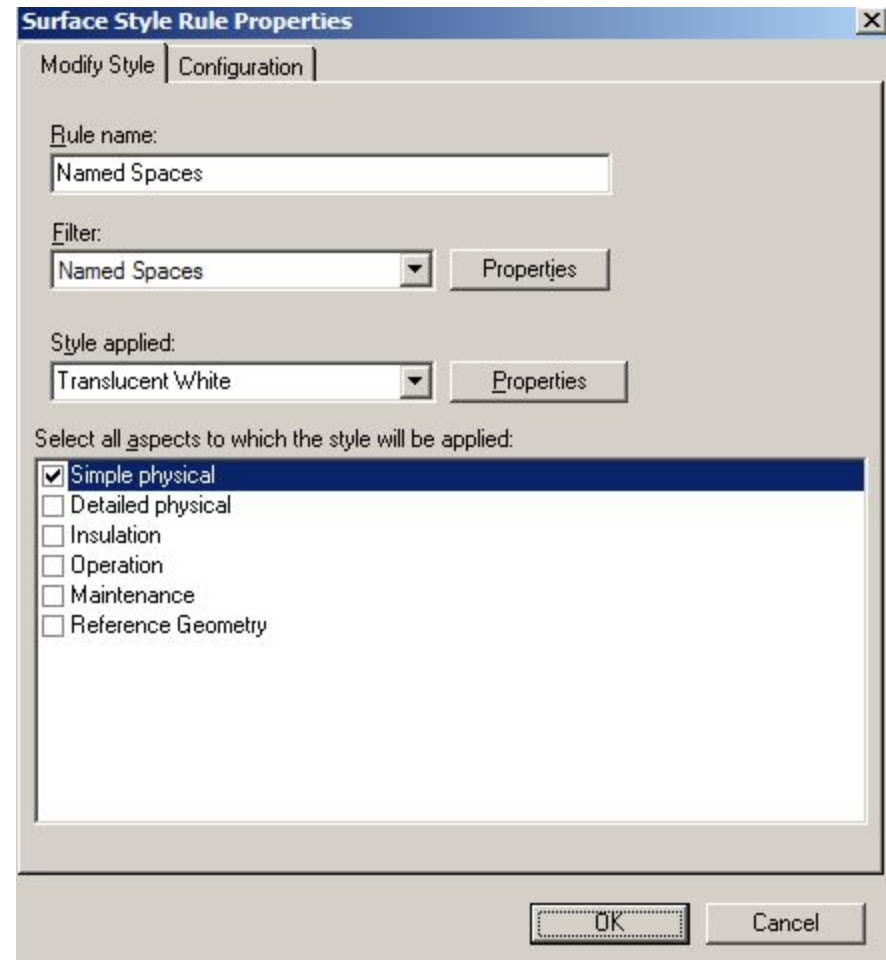

Applying Surface Style

- Surface style Rules is saved in the model database
- Surface style rule applied to the workspace is saved in the session file
- Copy/Paste functionality

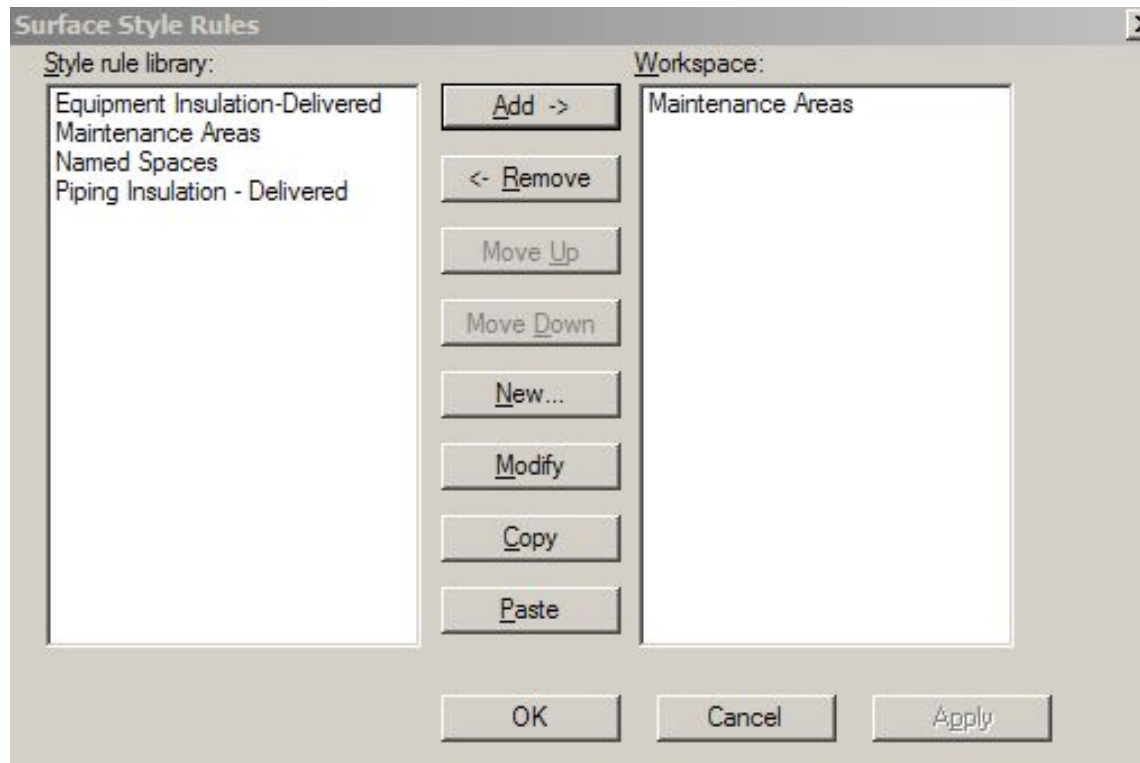

SP3D Practice Labs

- Manipulating Views
- Selecting Objects in a model
- Applying a Surface Style Rule

Hide/Show command

Hidden objects are displayed in Italic Text

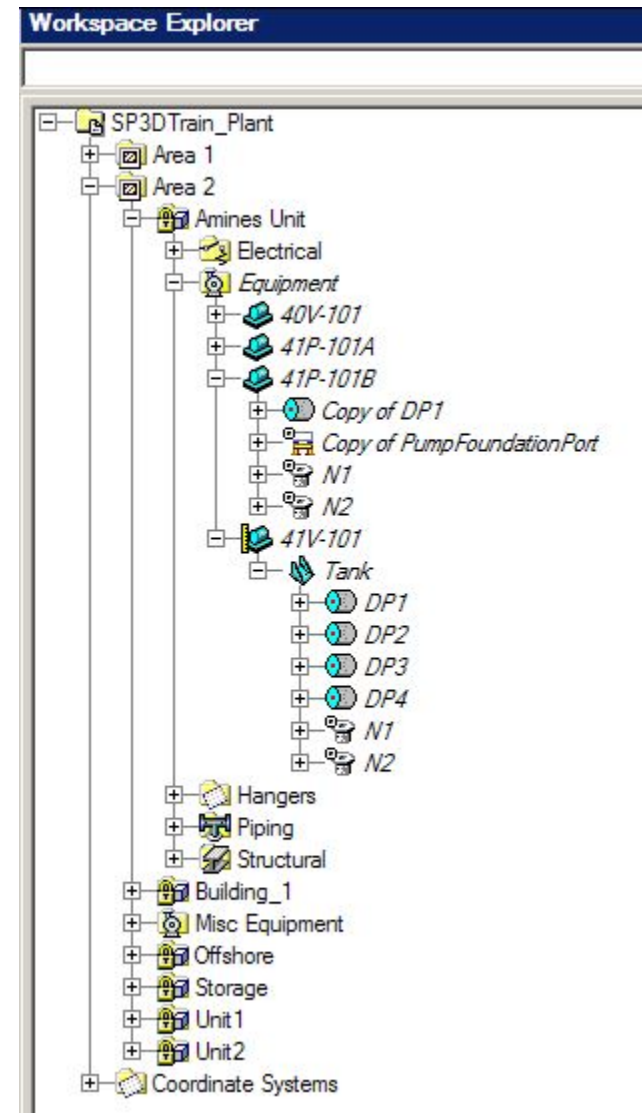

ToolTips

Label Editor

Allows to edit labels in an easy way using common User Interface

The edited label is saved in the model DB

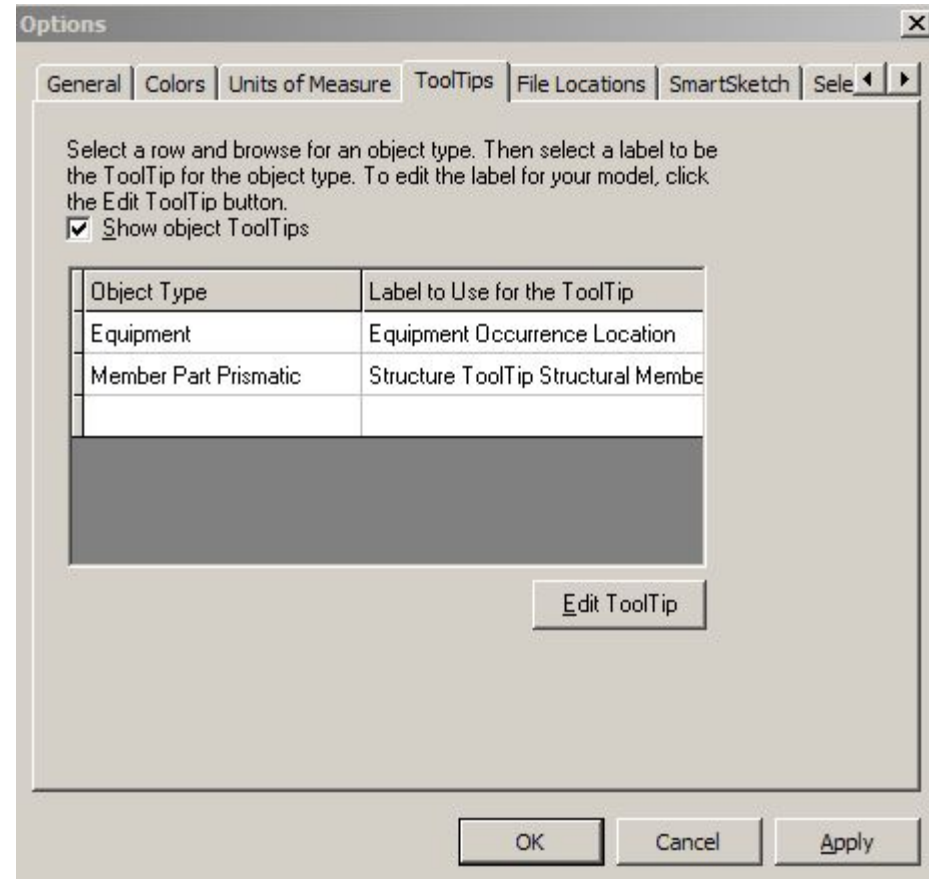

ToolTips

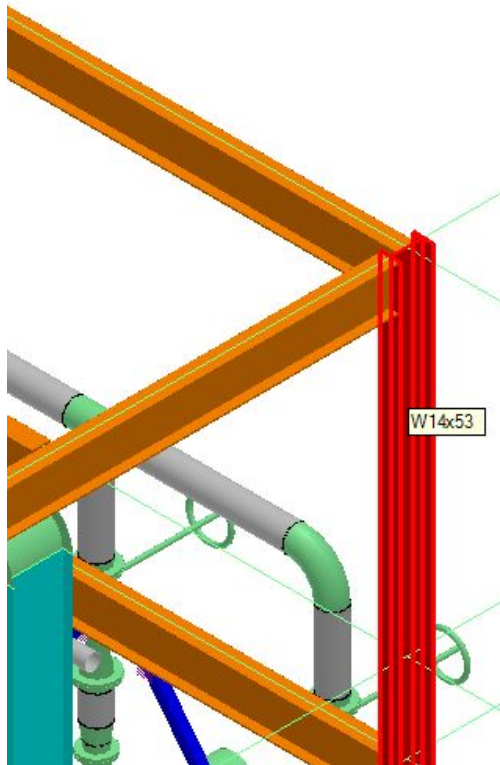

Edit Tooltip

Name: Description:

Properties

Property Name	Alias Name	Constant Type	Constant Value
Name	Name		
Section Name	SectionName		

Layout

Work Breakdown Structure

- Creates a relationship in the database between each object in the select set and the selected Work Breakdown Structure (WBS) item in the workspace explorer. These relationships are displayed in the Relationship tab of the objects properties dialog box.
- WBS is an aid that assist Projects Admin., Project leads, and Project Managers with Organizing, managing and grouping several different projects within the same plant.

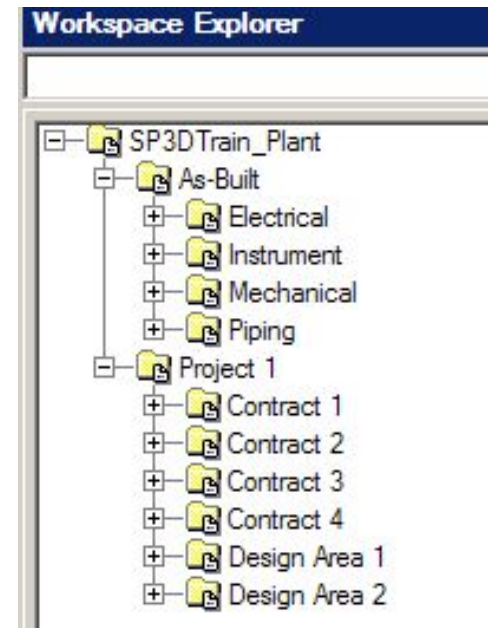

Control Points

Definition

- A 3D object representing a point in the model
- Drive label locations on orthographic drawings
- Placement method:
 - Insert Control Point Command
 - Define in the Symbol Definition
- Control point location is user defined
- The position can be declared to be at a fixed global position or the positioning method can be associatively maintained.
- The control point is associative to a parent object
- Control Point graphics is a sphere that does not support interference detection
- Control Point is displayed in Reference Geometry Aspect

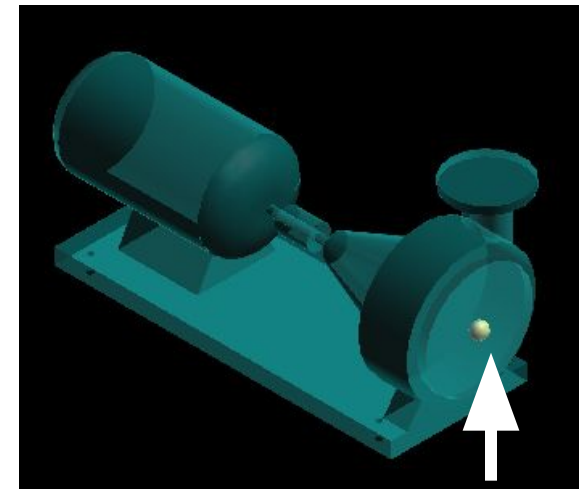

Control Point

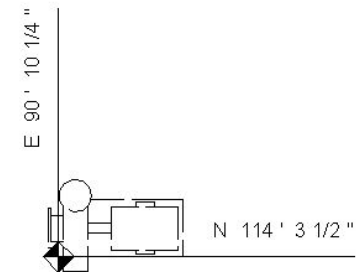

Checking Interferences

SP3D provides two mode of operations:

- Server-based Interference checking (Database Detect).
 - Run on a separate IFC server
 - Look for all interferences for the full model
- Interactive interference checking (Local Detect).
 - Help the designer in real time
 - Local to a session (what you see in your workspace)

Checking Interferences

Major Differences between the two methods:

Database Detect	Local Detect
Runs all the time (System Admin. choice)	Works only within the current session
Minimizes impact on users and improves performance	Provides immediate graphical feedback (works in a dynamic mode)
Creates persistent interferences that are stored in the model database	Shows interferences when the pointer is idle for a brief amount of time; based on a hesitation approach
Based on administrator settings (controlled by permission groups)	Based on individual user settings
Provides feed back on how much has been checked	Checks only created and modified items
Users can visualize the interferences (persistent items)	Clears dynamic interferences after refreshing workspace

Checking Interferences

IFC is available in all Task

Very simple and intuitive GUI

Ribbon bar includes:

- Settings
- Visualization
- Review & Approval

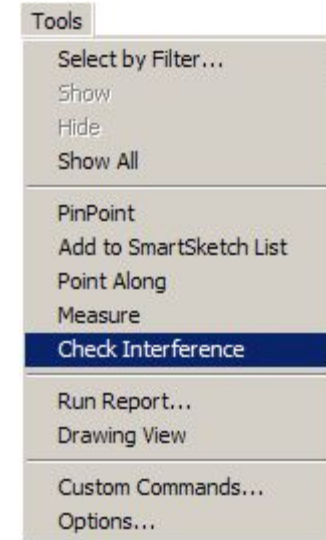

Interference List						
Part A	Part B	Type	Required Action	Last Modified	Notes	
PUMP001A_IMP-HV-0207	PUMP001A_IMP-HV-0206	Severe	Edit - must resolve the interference	12/4/2003 12:40:00 AM	John should review this interference	
PUMP001A_IMP-HV-0204	PUMP001A_IMP-HV-0202	Severe	Edit - must resolve the interference	12/4/2003 12:39:00 AM	Peter need to review	

Wrap text Close

Checking Interferences

Three type of checking (based on the object aspects):

- Required
- Optional
- Not Checked

Can process:

- Required – Required
- Required – Optional
- Optional – Optional

A clearance rule can be used

Checking Interferences

- Any persistent interference detected by the Database Detect process appears as a sphere
- Interference detected by the Local Detect process appears as a box

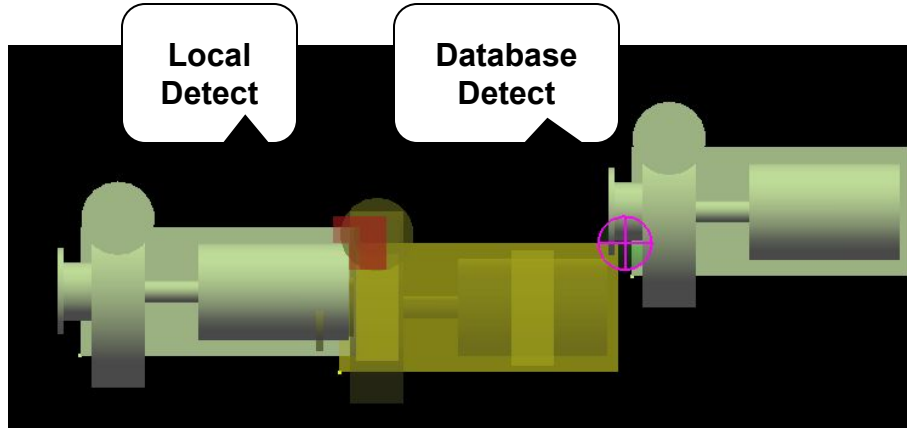

To Do List

- An object's relationship with another object become inappropriate, the system generate an **Error** entry in the To Do List.
- A relationship has changed between to object, but the person who modified the objects only have write access to one of the object. The system generate an **Out of Date** entry in the To Do List



Object name	State	Changed by	Date modified
Cableway Straight Feature	In Error	INGRPPD\rhim	10/29/2005 6:46:11
Cableway Along Leg Feature	In Error	INGRPPD\rhim	10/29/2005 6:46:11
Route Connection	Out of date	INGRPPD\rhim	10/29/2005 8:03:37

Displays list of objects that are in Error or Out-of-date

Design Re-use

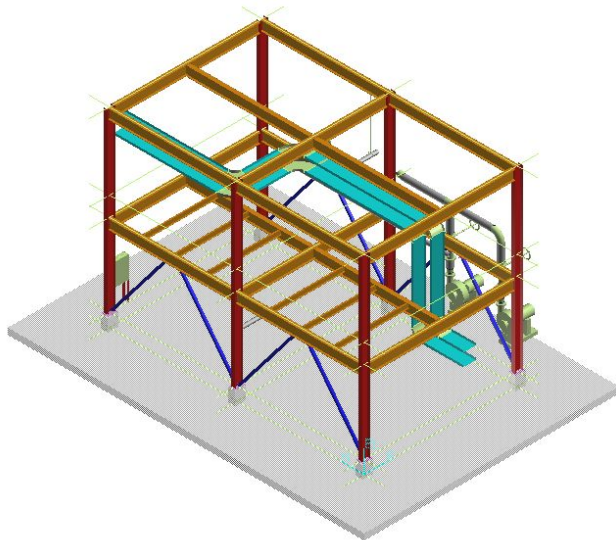

Unit1

Copy to Catalog
or
Instance in
Another Location

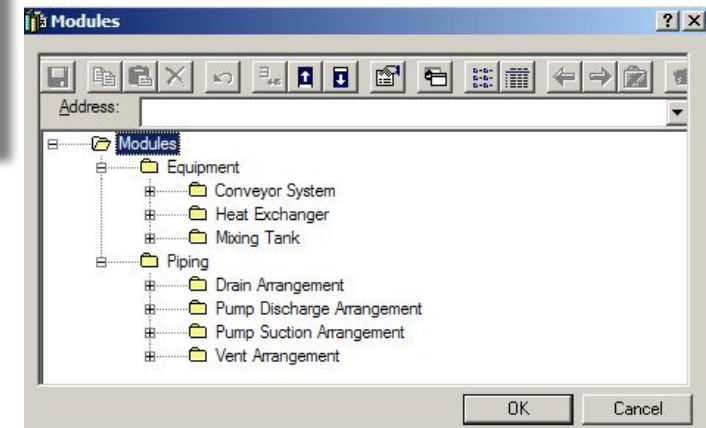

Internal Relationships
Maintained.
External Relationship Exposed.