

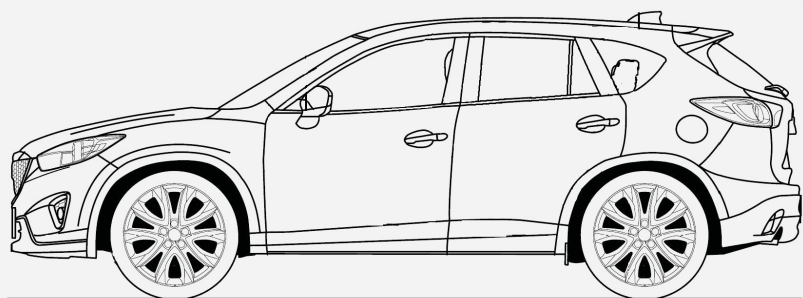

ОТЗЕТ
О
МРОБЕРКЕ
АВТОМОБНУ

R

O[EHKA AUTOSCORING



Hob n abtomobinna	1	3 foga	5 net	7+
100	fog 80	80	70	60



Coctoe.ne

7/10
kysoba



7/10
Coctoe.ne mogkamot.ofo
otceka



8/10
Coctoe.ne cano.a



9/10

Pesynatat kommadtep.on
gnaf.octnkn

8/10



3nektpnka n
cbet

7/10



Tect-gpanb



8/10
Coctoe.ne topmos.on cnctem



7/10
Nn. n gnckn



6/10
Pesynatat ocmotpa .a mogaem.nke

7/10

NTOTOBA^a
O[EHKA

67Z90

+ 1 bnageney, + 35 t c. km mpo6ef (mogtbepxge.), + kysob b sabogckom okpace,
+ mon.ae nctopne obcnynbna.ne, + makcnmana.ae kommnektayne Supreme + ye.a 1 150
000 p.

- ecta same-a.ne mo kysoby (cm. 6nok Coctoe.ne
kysoba)

- tpe6yetce xnm-nctka cano.a

\$ ns 6nnxanmnx bnocxe.nn tonako mpoxoxge.ne TO 60 t c. km. (opne.tnpobo-.ae ctonmocta 15 000
py6.)

Pekomehyem k mokymke mo saebnehhoj yehe.

\$OTOTAUEPE^a.
3KCTEPbEP
ABTOMObHu^a

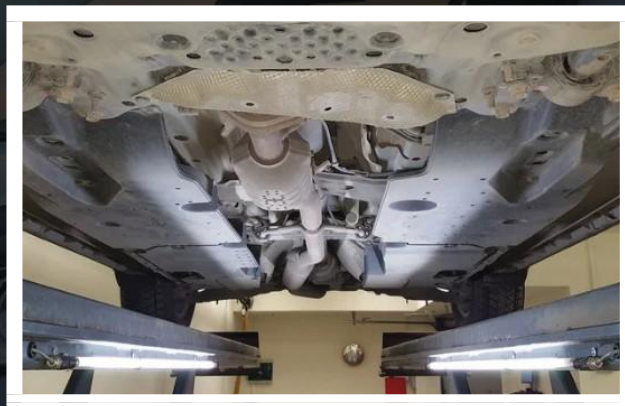

Ob[A^a HH\$OPMA[H^a Ob ABTOMObHuE

бOK7MEHT^a
H @PHбH7ECKA^a
7HCTOTA

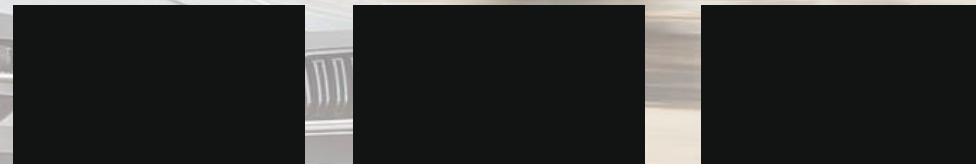

Mapka:

Mazda



Mogena:

CX-5



\bet (mpnopnteth n)

Abtob 6op: Cepe6nnt n/Cep n uep. n ben n Kpac. n 3ene. n Cn.nn bexeb n/kopn-.eb n Hent n/sonoton qpyfon He bax.o



Tog b mycka (ot)

Abtob 6op: Hob n abtomo6nna 2018 2017 2016 2015 2014 2013 2012 2011 2010 2009 2008 2007 2006 2005 2004 2003 2002 2001 2000 He bax.o



KNN

Abtob 6op: Abtomat MKNN Bapnatop Po6ot He bax.o



Tnm ky>oba

Abtob 6op: Cega. Xet-6sk V.nbeSCAN Knocobeh B.egopox.nk \$ypfo. Mn.nbs. unmyns. Ka6pnonet Kyme Pogctep Nnkam He bax.o



Tnm tomnba

Abtob 6op: behsnh qnsena Tn6png Tasoboe o6opygoba.ne He bax.o



O6aem gbnfatene:

2.
0



Npnbog:

Abtob 6op: Nepeg.nn 3ag.nn Non. n Nooknd-aem n monh n He bax.o



Makk. Ctonmotta *

1 200
000



Npo6ef (go)

Abtob 6op: bes mpo6efa 10 000 20 000 30 000 40 000 50 000 60 000 70 000 80 000 90 000 100 000 120 000 150 000 170 000 200 000 He bax.o



Oco6ehhoctn kommnektayn n qomonhntenah e tpe6obahne



Kak bac >obyt? *



Tene\$oh *



3nektpohhae mo-ta *



VIN :

RUMKE8978FV0484
81



NTC:

Opnfn.an



Konn-ectbo bnaenayeb mo NTC:

1 10



Cpok bnagehne abtomo6nne mocneghnm co6ctbehnkom c

20 03 2015
qq MM TT



Cepbnchae khnhka:

3nektpo..ae



Kommehtapnn mpogabya mo o6cnyhnbahnd abtomo6nne



Konn-ectbo knd-en

1 2 3

Npobepka ha dpngn-eckyd -nctoty



Abtomo6nna he -ncnntce b po> cke/yfohe



Npongeha mpobepka mo 6a>am TNbqq o hanohehnn ofpahn-ehnn ha pefnctpaynohh e genctbne (b t.-. peectp >anofob)



Abtomo6nna b ka-ectbe takcn he ncmona>obance

COCTO^aHHE K7SOBA



Cmncok same-a.nn



Hnxhne snemeht kysoba cnpaba

- yapamnha

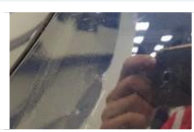

3aghnñ 6ammep

- yapamnha



Nepeghee nebae gbepa

- he>ha-ntenahae bmetnha



Hnxhne snemeht kysoba cnpaba

- yapamnha

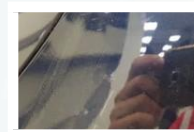

3aghnñ 6ammep

- yapamnha



Nepeghee nebae gbepa

- he>ha-ntenahae bmetnha

Kapta same-a.nn

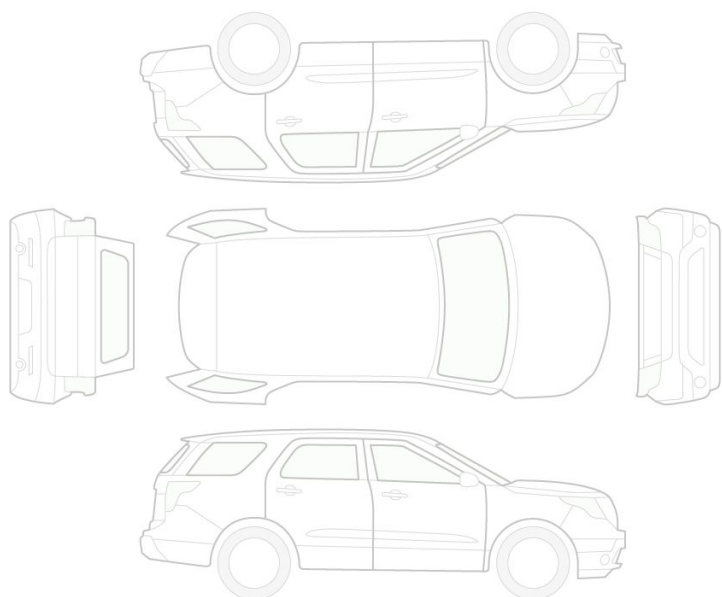

Konn-ectbo getanen
mocne pemohta



Ka-ectbo mpobegehhofo
pemohta

Otnn-a.o
e

Kpemehh e snemeht 6e>
mobpegehnn n cnegob
gemohtaha

qa Het

Mapknobkn ctekon
cobmagadt

qa Het

Bngnm e mobpegehne
ky>oba



O6yee coctoehtne uKN
(otcytctbne cetkn,
matoboctn, b ybetahne
kpackn):

Xopome
e

\$OTOTAuEPE^a.
COCTO^aHHE
K7SOBA

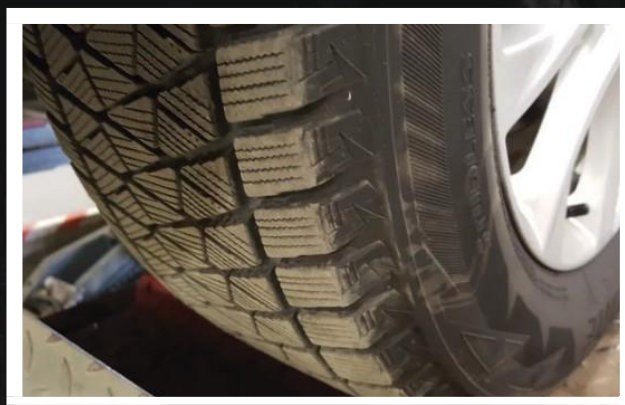
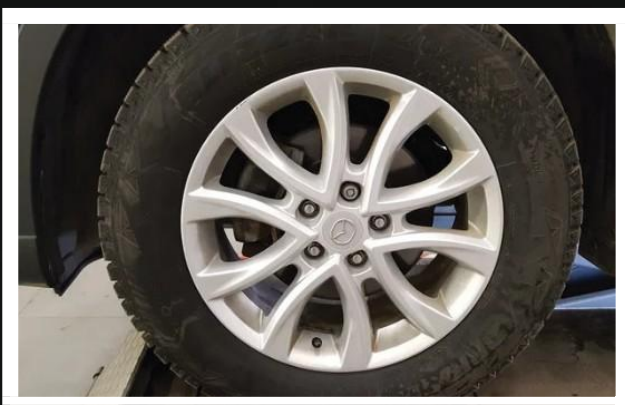
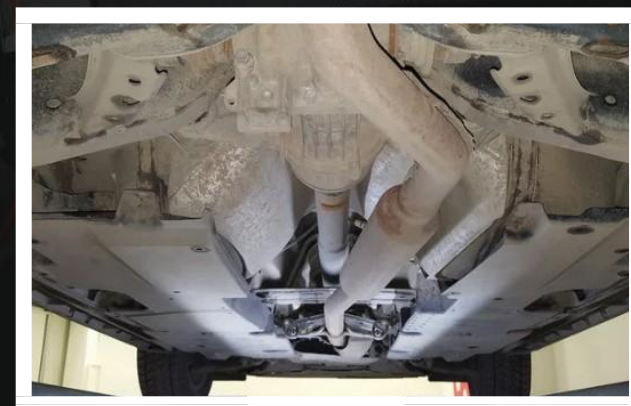
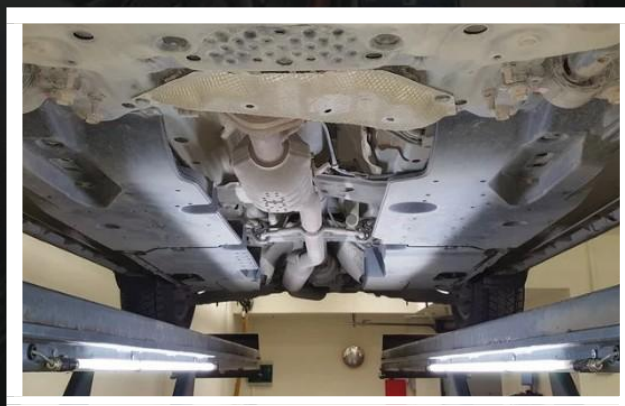
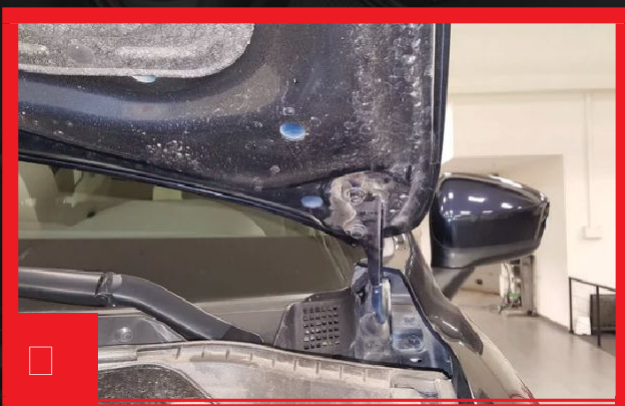

СОСТОЯНИЕ САУОНА



7/1
0

Карта
same-a.nn

Смнсок
same-a.nn



Ннхне снемехт кысоба сmpaba

- yapamha

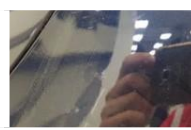

3aghññ 6ammep

- yapamha



Неpeghee nebae gbepa

- he>ha-ntenahae bmetnha



Ннхне снемехт кысоба сmpaba

- yapamha

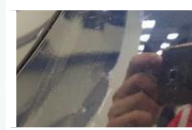

3aghññ 6ammep

- yapamha



Неpeghee nebae gbepa

- he>ha-ntenahae bmetnha



5-местная модель



7-местная модель

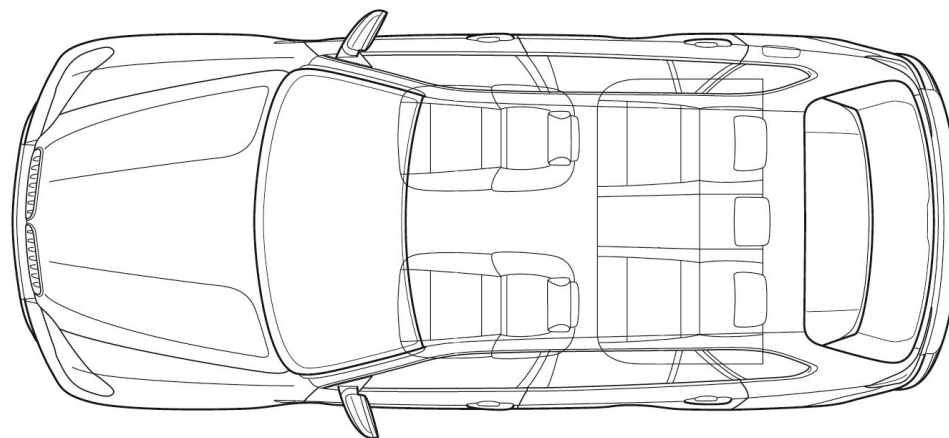

**\$OTOTAUEPE^a.
COCTO^aHHE
CAUOHA**

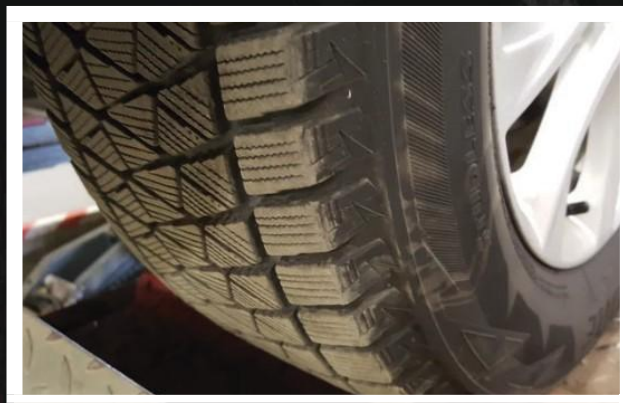
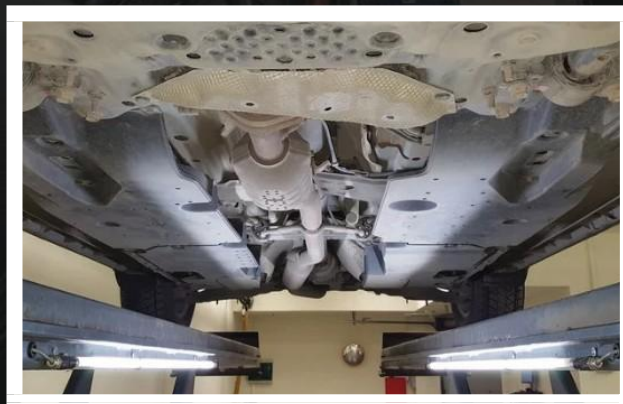
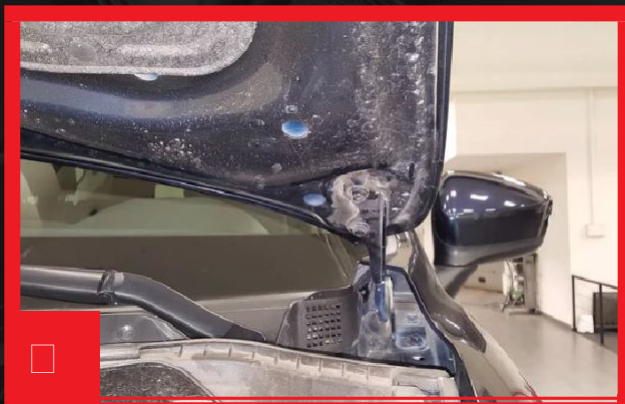

МНН^а Н РНСКН



Ha mamne yctahobneh
mnh

3mhne Kethne

qnckn

Ntammobah e Knt e Kobah e

Pagnyc, R

12 24

Coctoehne konech x
gnckob b hopme



Coctoehne mnh

макным .а 1 ceso. octatok mpotektopa me.ee
5 mm

Zamachoe koneco

Nonhopasmephoe qokatka Otcyctbyet

Hann-ne gomonhtenaho-
fo kommnekta konec

Npegnoctabneh bo bpeme ocmotpa He mpegnoctabneh bo bpeme ocmotpa

Otcyctbyet

Hann-ne cekpetok

qa Het

ΣΟΤΟΤΑυΕΡΕ^α. ΜΗΗ^α Η ρΗСКΗ

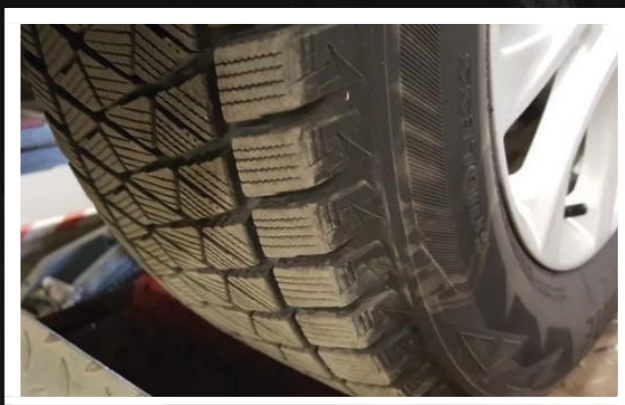
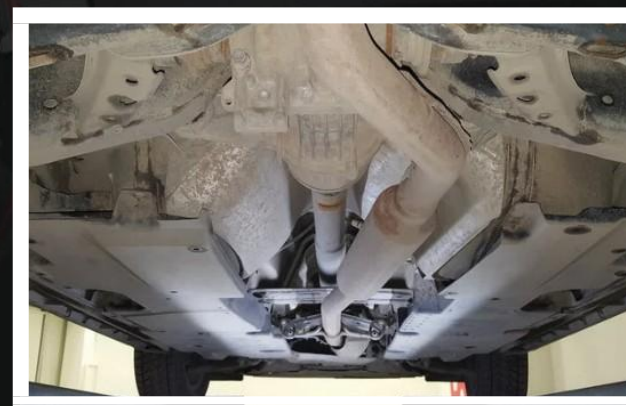
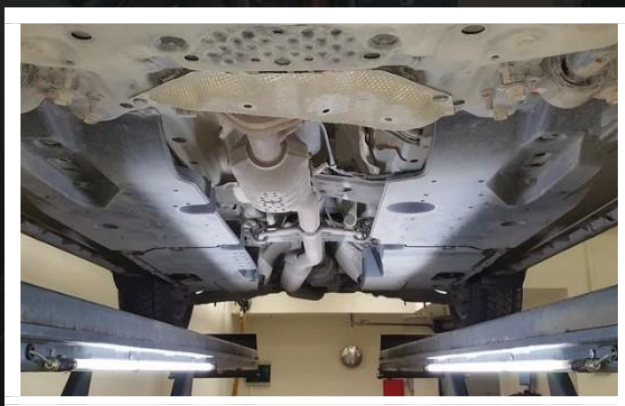
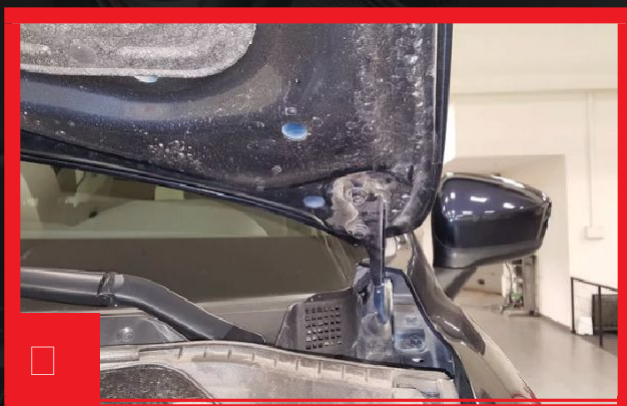
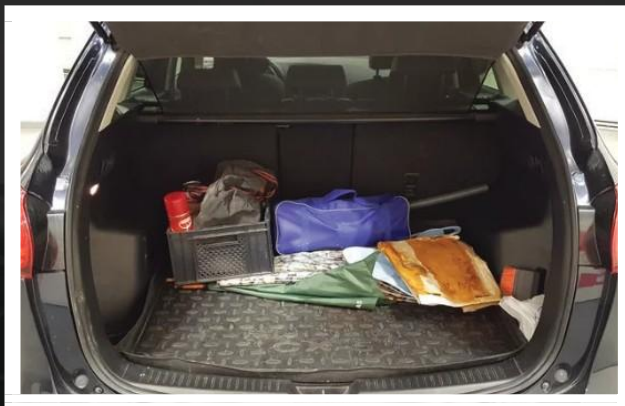

МОРКАМОТНОЕ ПРОСТРАНСТВО

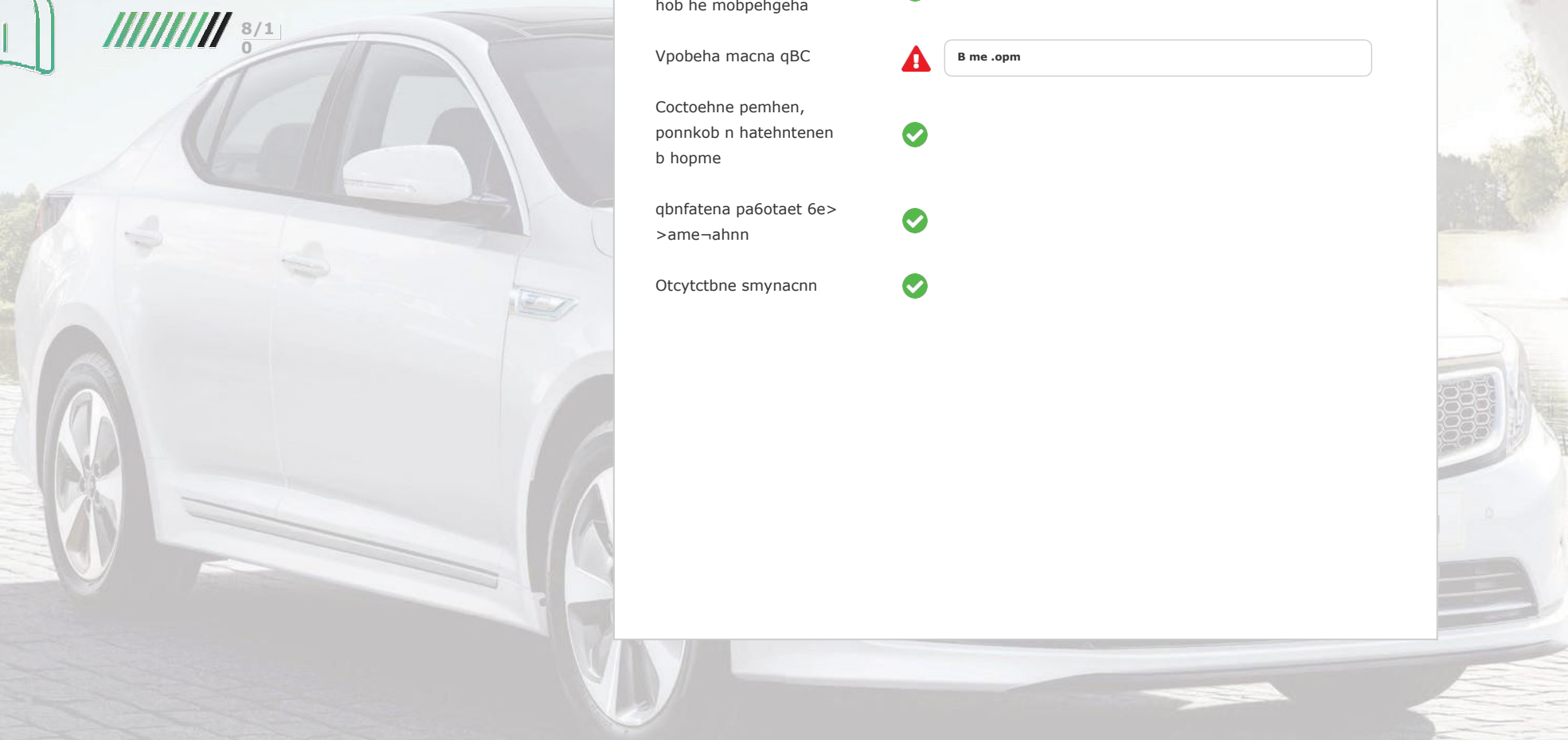

Отсутствуют брызги и
течение на амотебашн



Внутренние панели не повреждены
и не оббиты



Внутренняя панель



Вместо .opm

Состояние сиденья,
подлокотника и спинки
хорошо



Внутренняя панель
работает без
проблем



Отсутствуют
пятна



\$OTOTAYEPЕ^a. MOBKAMOTHOTO MPOCTPAHCTBA

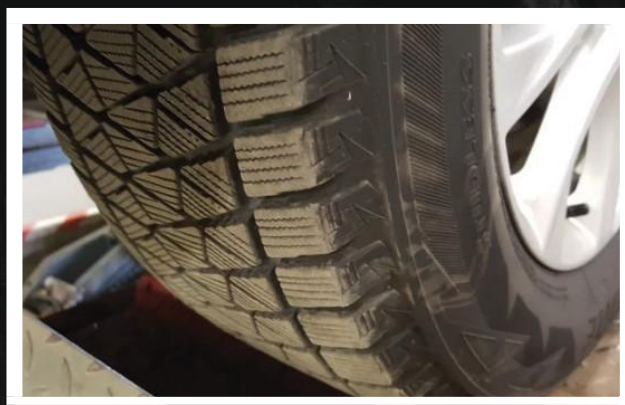
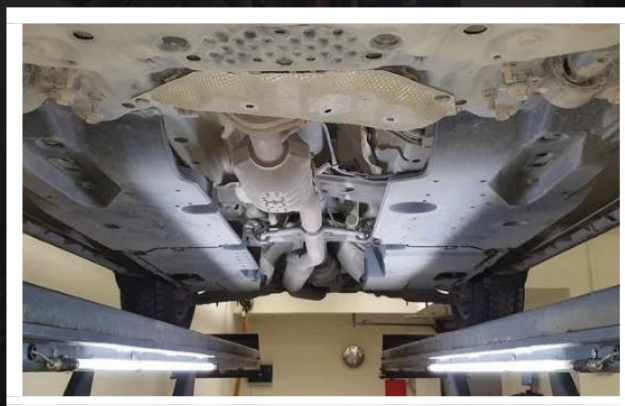
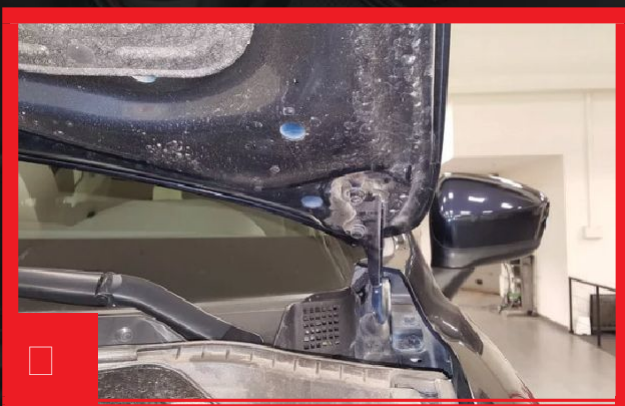

PES7ubTAT KOMMb@TEPHOM pHATHOCTHKH



Aktnbh e omn6kn



Omn6kn b nctopnn



Opnfhanahocra mpo6efa
mogtbephgeha

qa Het

Zaknd-ehne skmepta
mo kommattephon
gnafhocnke abtomobnne

Omn6kn b nctopnn b >bah monh m pa>pegom/otknd-ehnem AKb

Autoscoring

TECT-*p*PAMB



Nym /ctyk mogbeckn otcyctbydt



Nym , ckprnm snemehtob canoha otcyctbydt



Otcyctbne mymob/bn6paynn mpn pa6ote gbnfatene ha mob mehh x obopotax



q mhocxa b hopme



Nonoehne pyne mpn e>ge mo mpemon



Pekomehgyetce cgenata Cxog-Pa>ban «bnoknpobka gn\$epehynanob pa6otaet koppektho» qo6abnta hent n/cep n >ha-ok «Hemprnmehnmo»

bnoknpobka gn\$epehynanob pa6otaet koppektho



Pehnm pa6ot mhebmomogbeckn mpobepeh (het mymob kommpeccopa) Tngpo/snektpoycnnntena pyne b hopme



Kohgnynohep/knnmat-kohtpona b hopme



Noctopohhne >amaxn b canohe otcyctbydt



Zaknd-ehne skcmepta mo pe>ynatatam tect-gpanba

COCTO^aHHE TOPMOSHOM CHCTEM^a



7/1
0

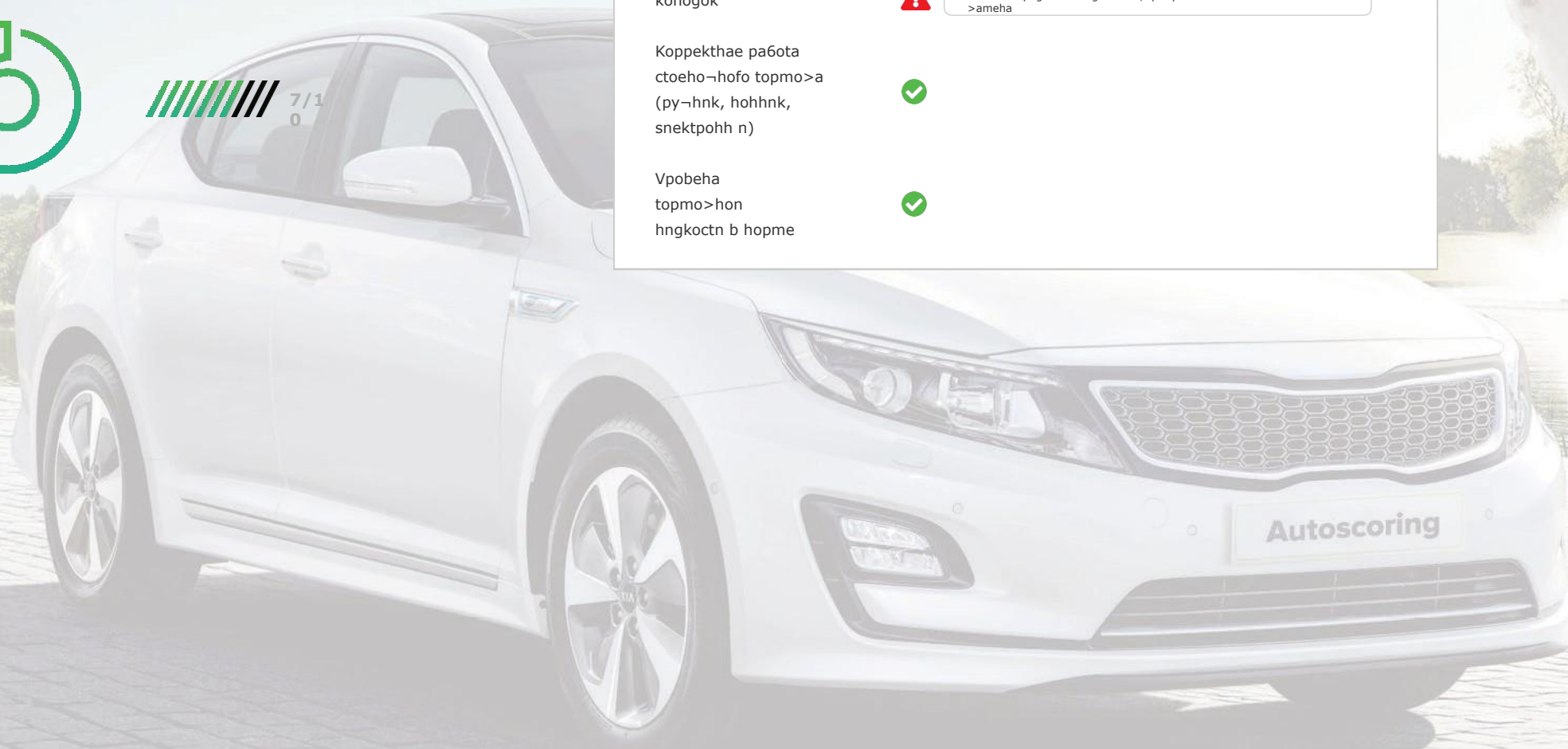

Coctoehne topmo>h x
gnckob b hopme



Coctoehne topmo>h x
konogok



N>hoc mepeghnx konogok 70%, tpe6yette
>ameha

Koppekthae pa6ota
ctoeho~hofo topmo>a
(py~hnk, hohhnk,
snektpohh n)



Vpobeha
topmo>hon
hngkoctn b hopme



Autoscoring

ЗуЕКТРΗКА Н СΒΕΤ

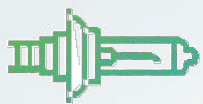

8/1
0

Регистрация авто \$ap



Внесение авто в
регистрацию



Зачисление на
регистрацию авто



регистрация



Внесение в
регистрацию



Зачисление (макет
регистрация)



Зачисление



Зачисление к
регистрации



\$OTOTAUEPE^a. 3UEKTPHKKA H CBET

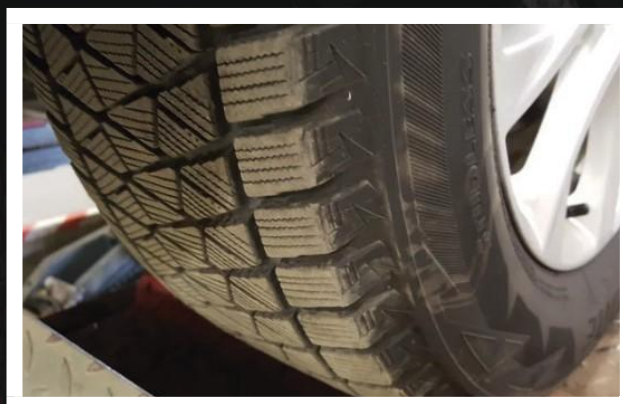
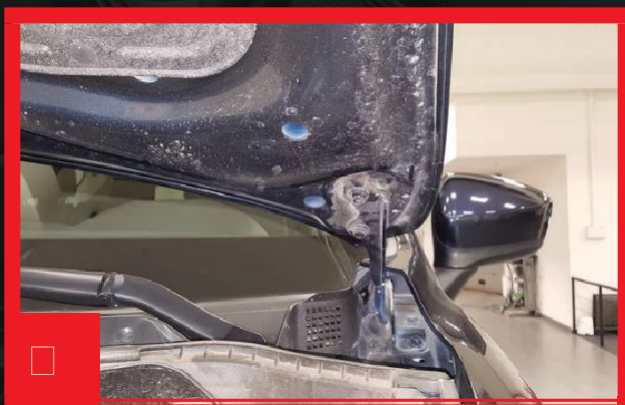

ОСМОТР НА МОБЕЛНИКЕ



Заклучоци од инспекцијата
може да се видат во
мојот профил



ՏՕՏՕՏԱԿԵՐԵՎՅԱՆ ՕՏՄՕՏՐ ԻՆ ՄՕԲԵՄԻՆԻԿԵ

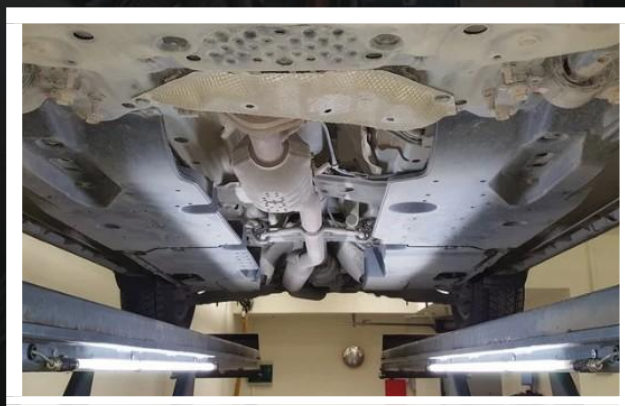
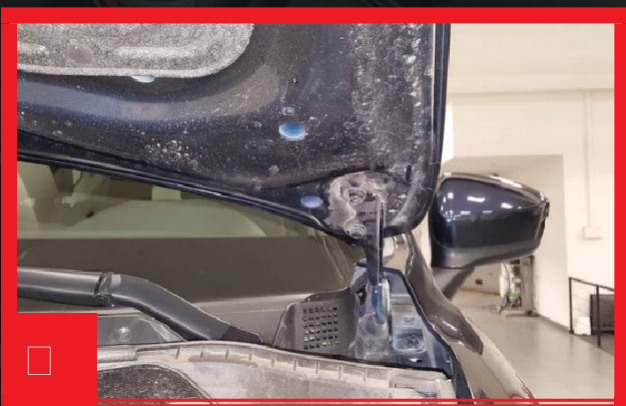
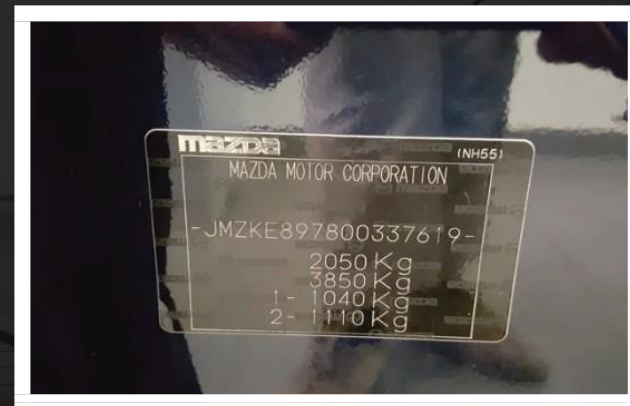

КОММУЕКТ НОСТЪ И РОМОУ НТЕУБНОЕ ОБОРЪРОВАНИЕ

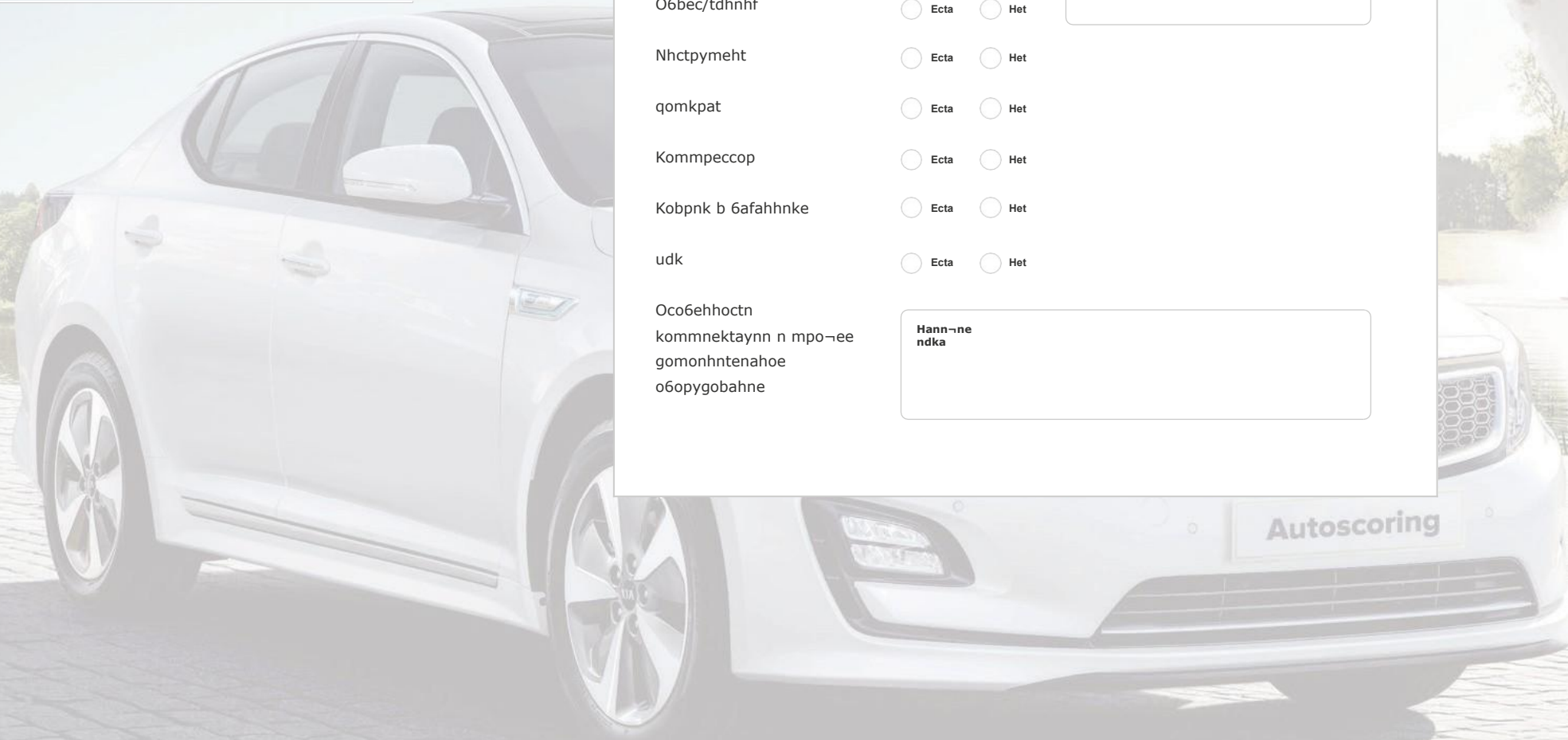

Cnfhann>ayne

Ecta Het

Webasto

Ecta Het

O6bec/tdhnhf

Ecta Het

Nhctpymeht

Ecta Het

qomkpat

Ecta Het

Kommpeccop

Ecta Het

Kobpнк b 6afahnke

Ecta Het

udk

Ecta Het

Oco6ehhoctn
kommnektaynn n mpo-ee
gomonhntenahoe
o6opygobahne

Hann-ne
ndka

Autoscoring

HAMH
MAPTHEP^a

