

Семейство SIMATIC S7

S7-400

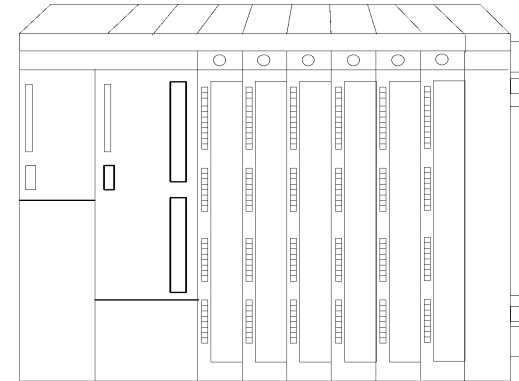

S7-300

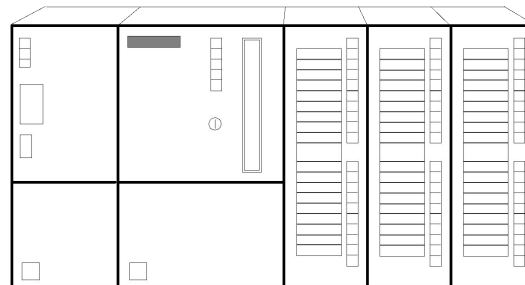

S7-200

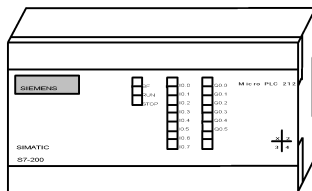

Программируемый контроллер S7-200

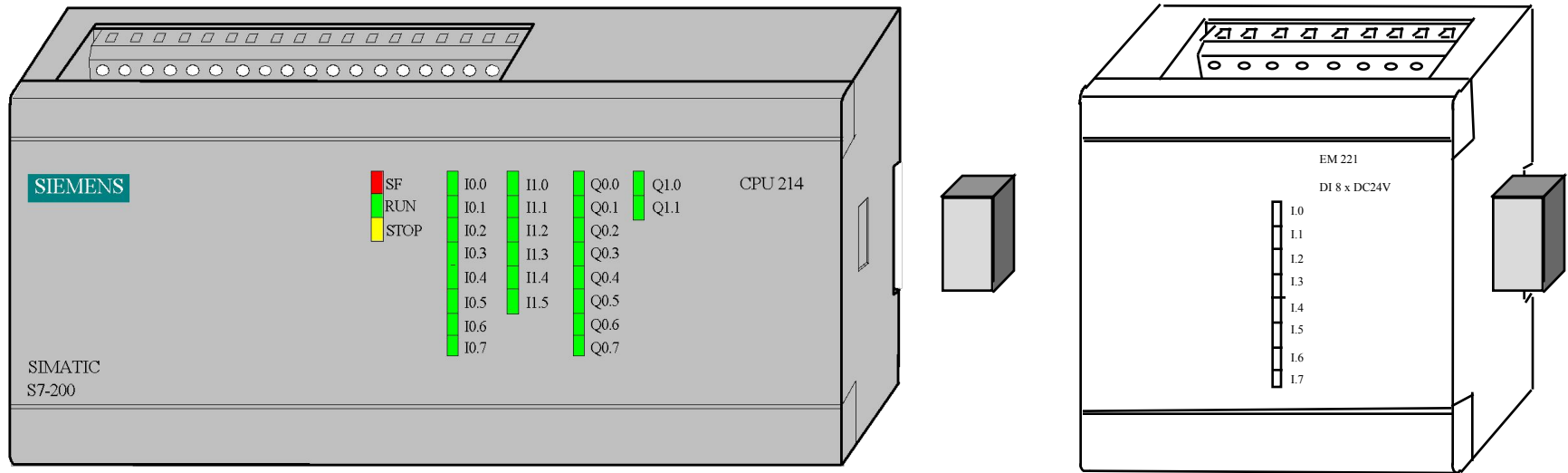

S7-200: Модули

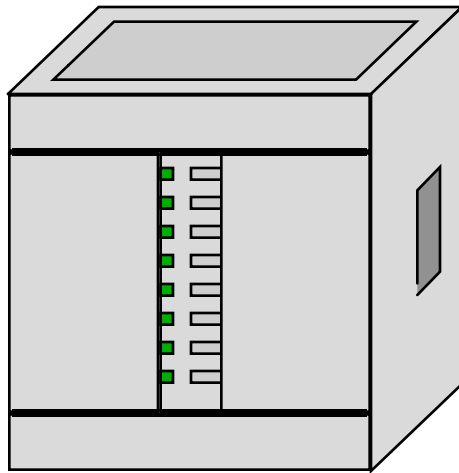

EM

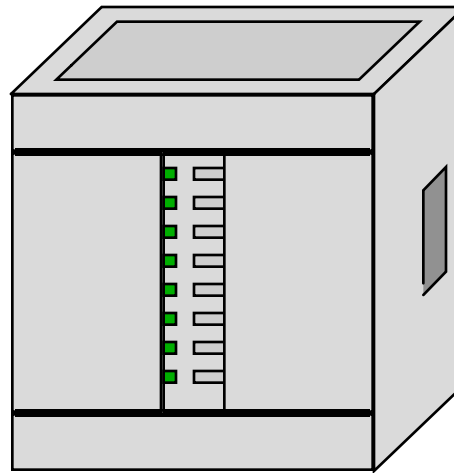
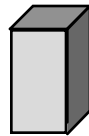

EM

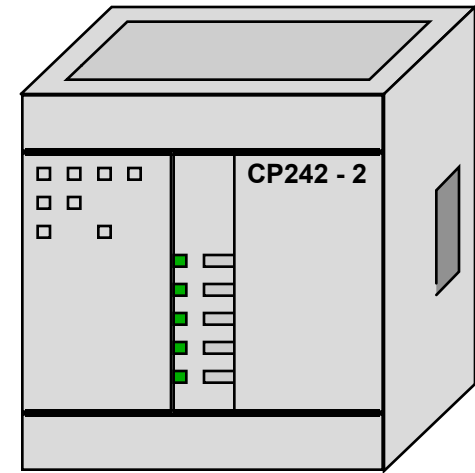
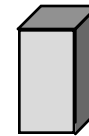

CP

S7-200: Внешний вид CPU

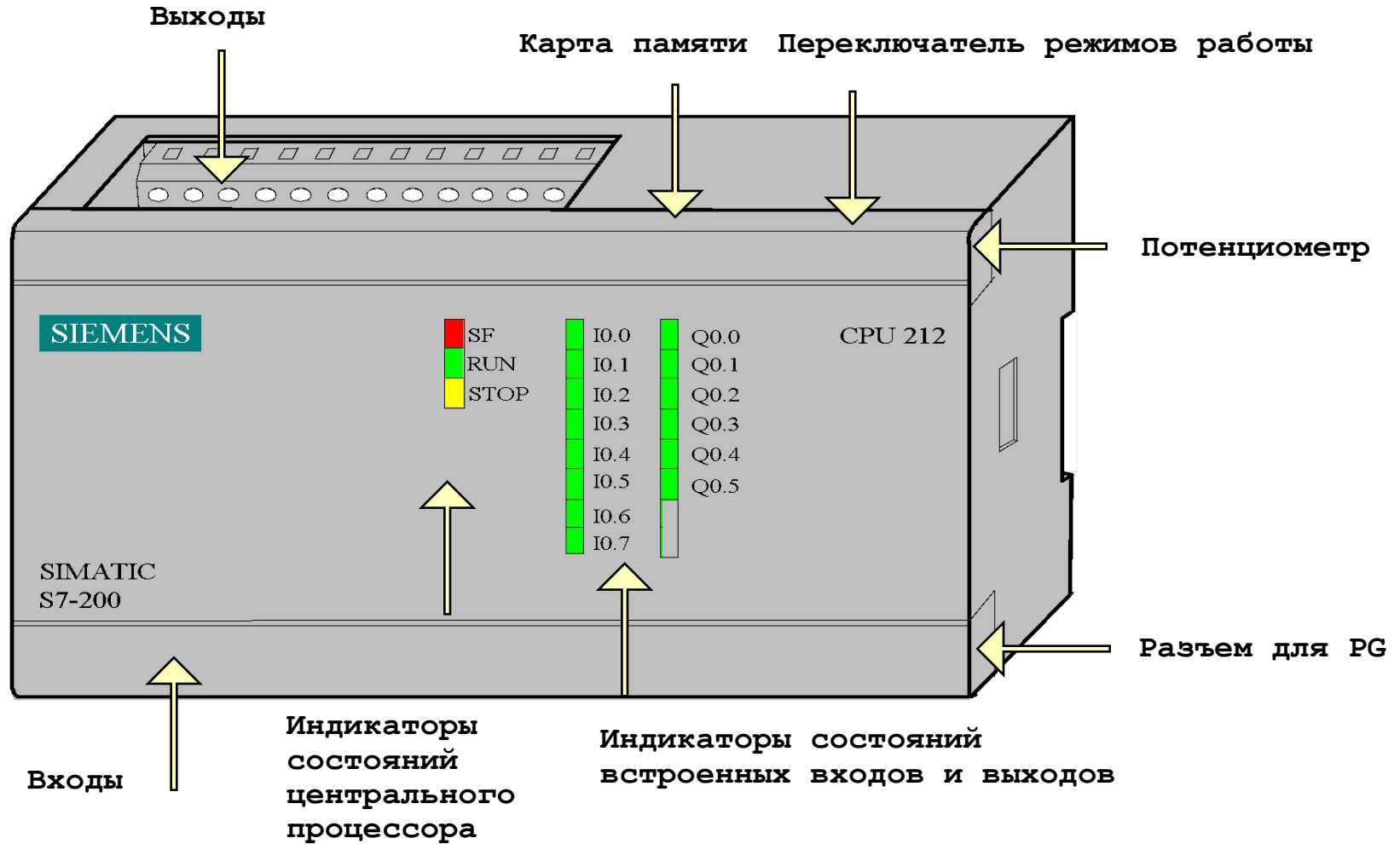

SIMATIC S7-300

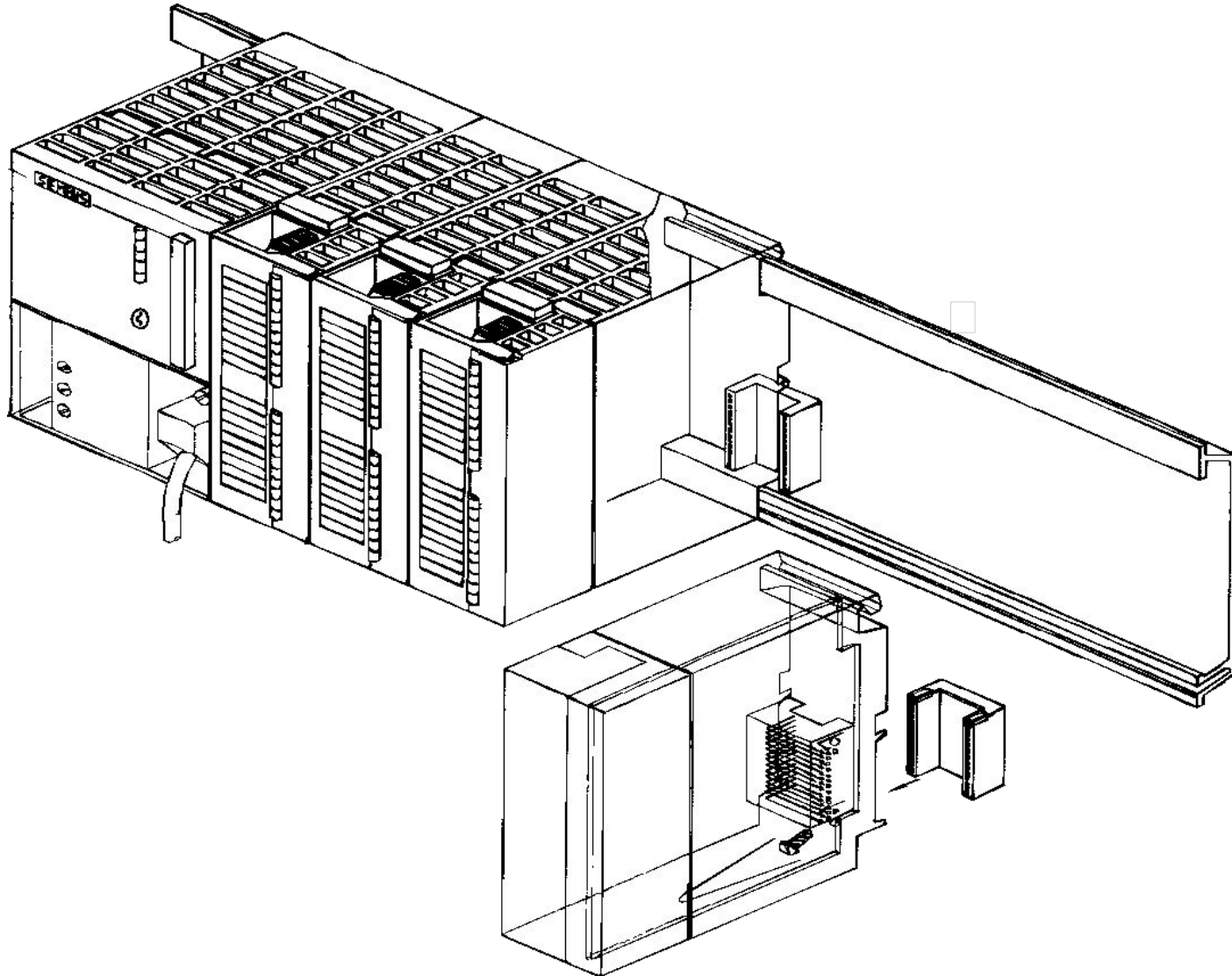

S7-300: Модули

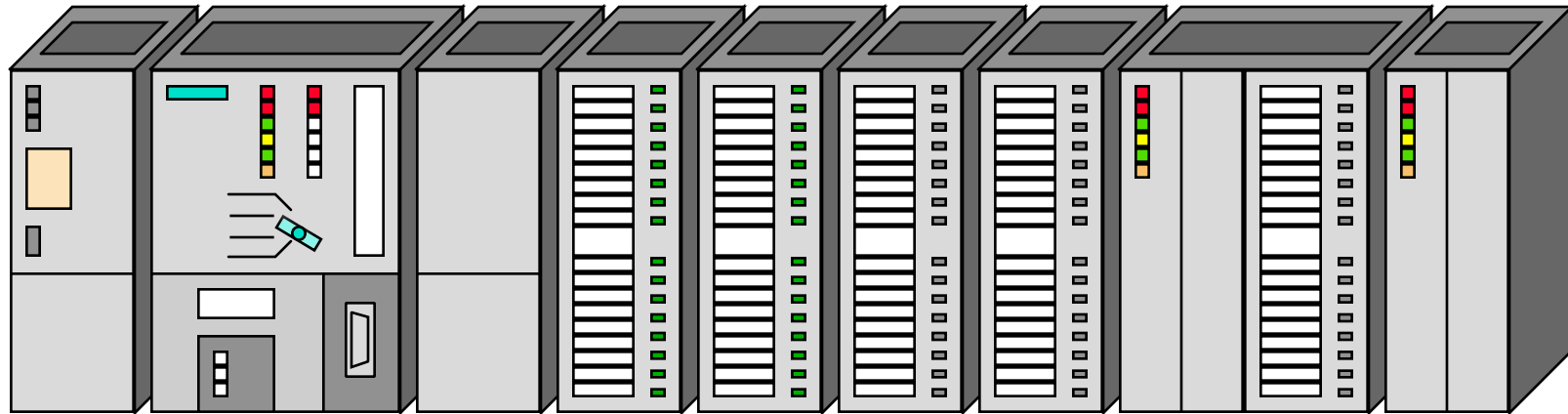

↓
PS
(по выбору)

↓
CPU

↓
IM
(по выбору)

↓
**SM:
DI**

↓
**SM:
DO**

↓
**SM:
AI**

↓
**SM:
AO**

↓
FM:
- Счет
- Позиционирование
- Регулирование

↓
CP:
-Точка к точке
- PROFIBUS
- Industrial Ethernet
- AS-интерфейс

S7-300: Внешний вид CPU

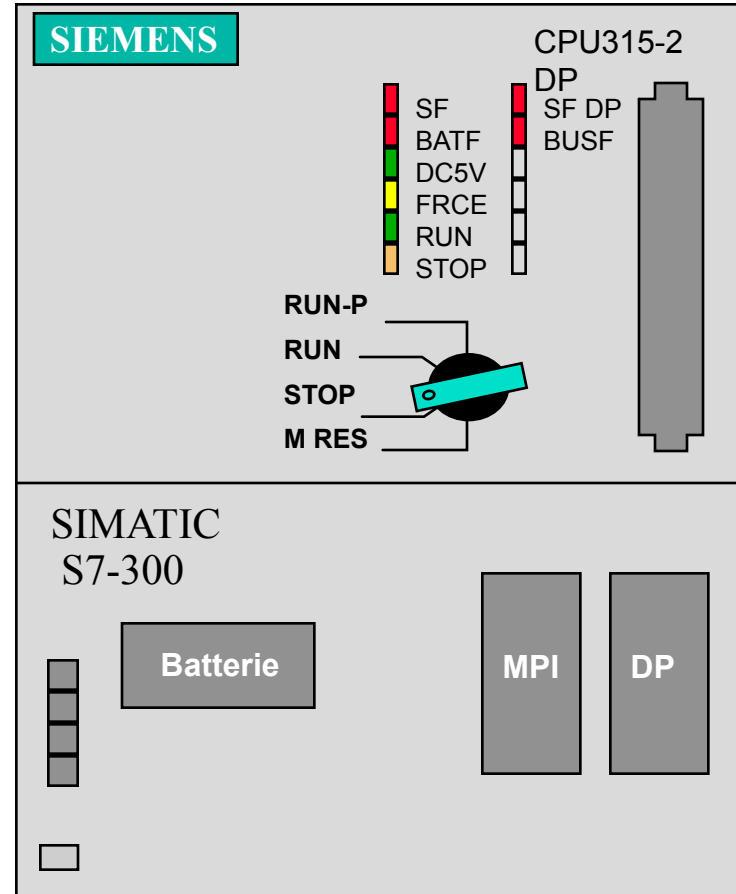
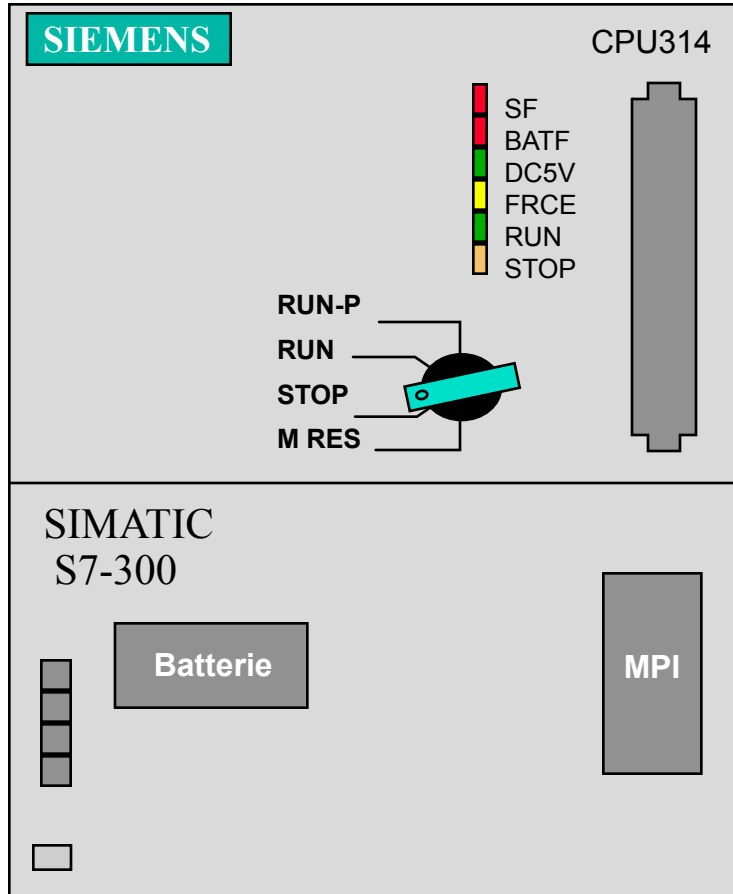

SIMATIC S7-400

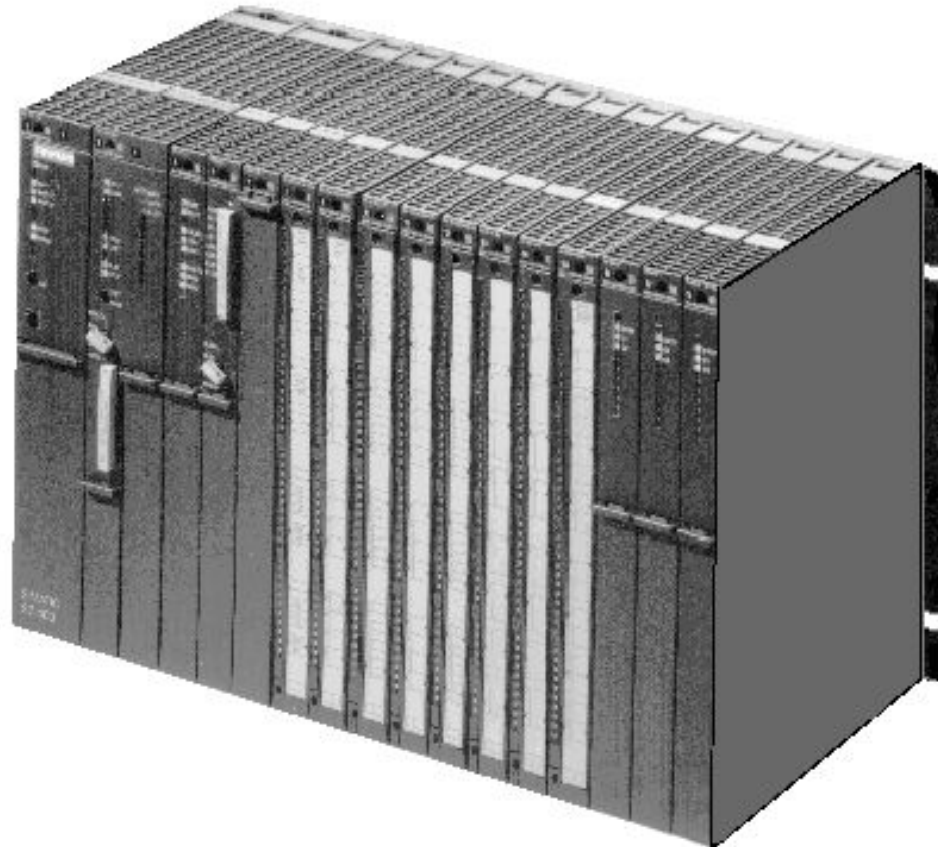

S7-400: Модули

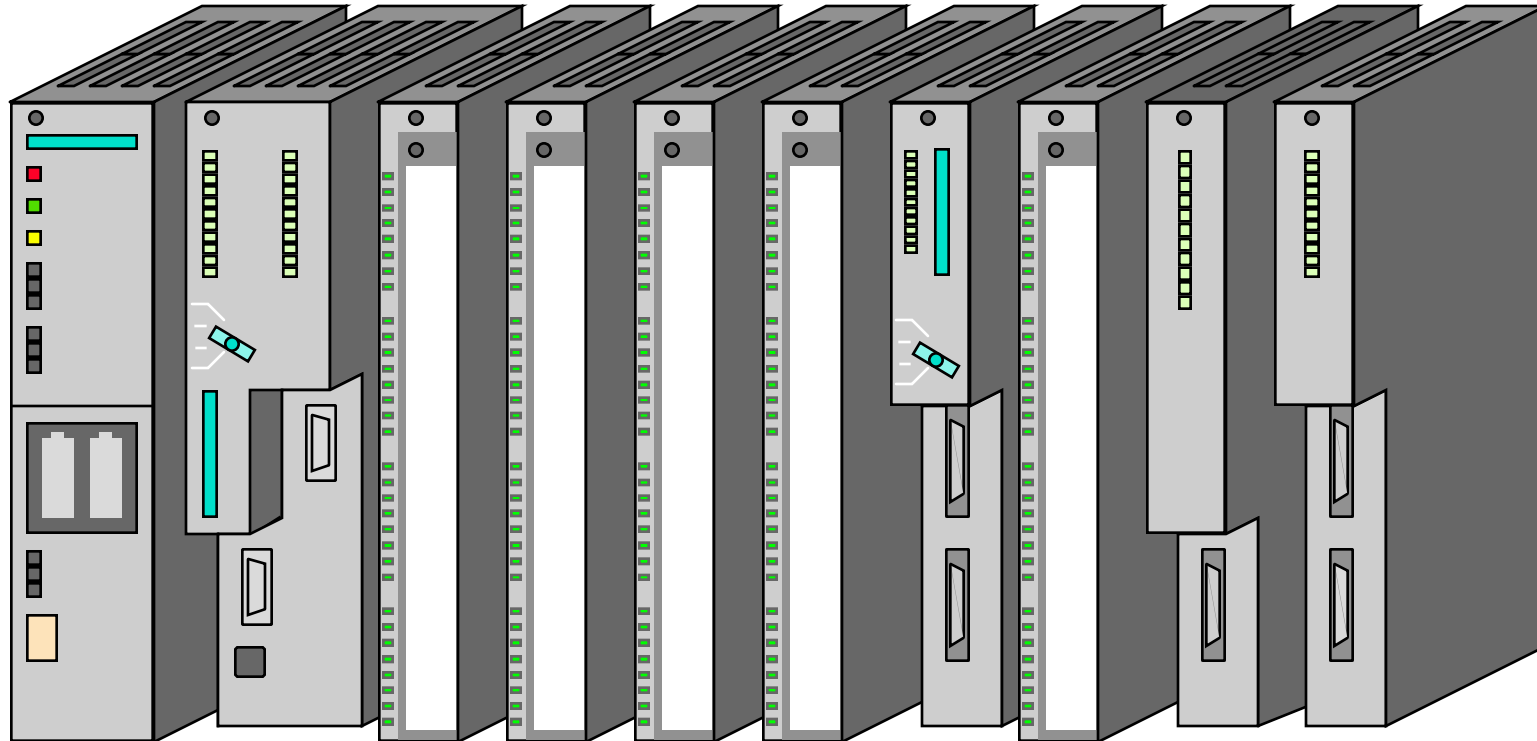

PS



CPU



SM:
DI



SM:
DO



SM:
AI



SM:
AO



CP



FM



SM



IM

S7-400: Внешний вид CPU (часть 1)

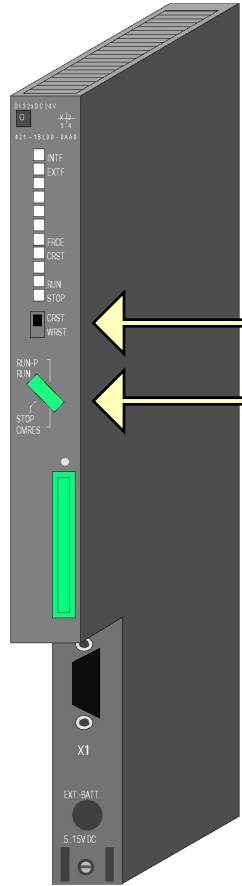

CPU412-1
CPU413-1
CPU414-1
CPU416-1

Переключатель
 видов запуска

Переключатель
 режимов работы

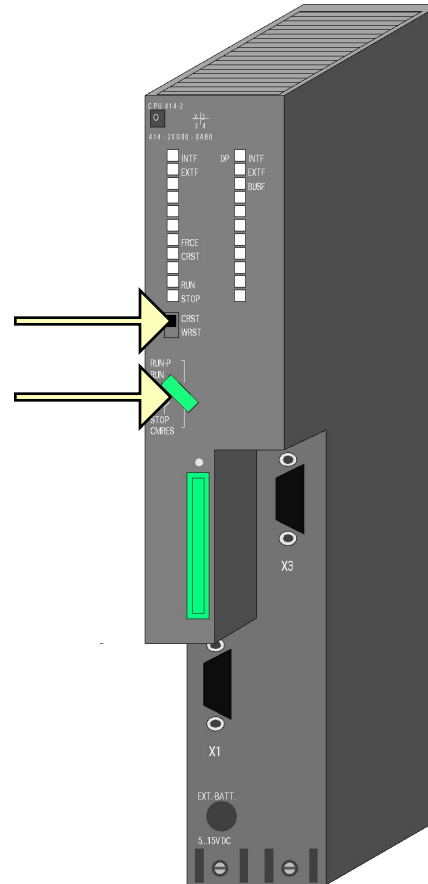

CPU413-2DP
CPU414-2-DP

S7-400: Внешний вид CPU (часть 2)

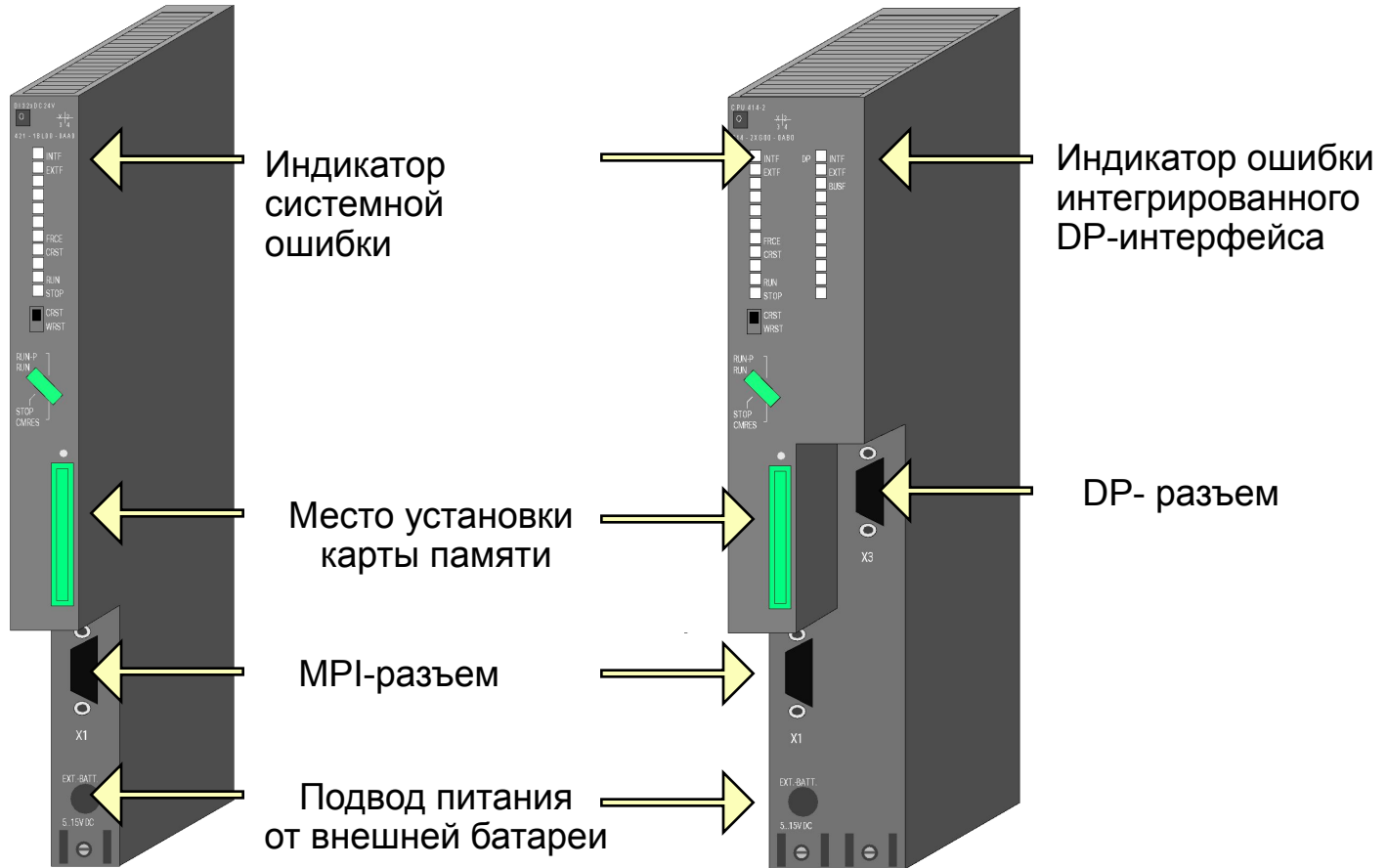

Программаторы

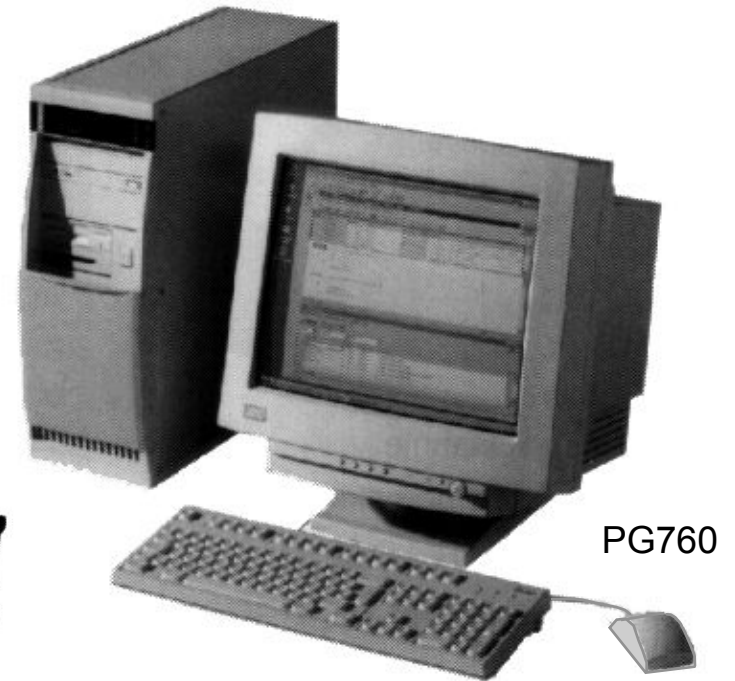

PG760



PG740



PG720