

Rule 18 Workshop

Chris Atkins

RYA Racing Rules Committee

Workshop Contents

**Basic Framework of Part 2
Rules**

Rule 18 explained

Rule 18 applied to situations

Basic Framework of Part 2 Rules

For any pair of boats:

One boat has to *keep clear*

&

the other is *right-of-way* boat

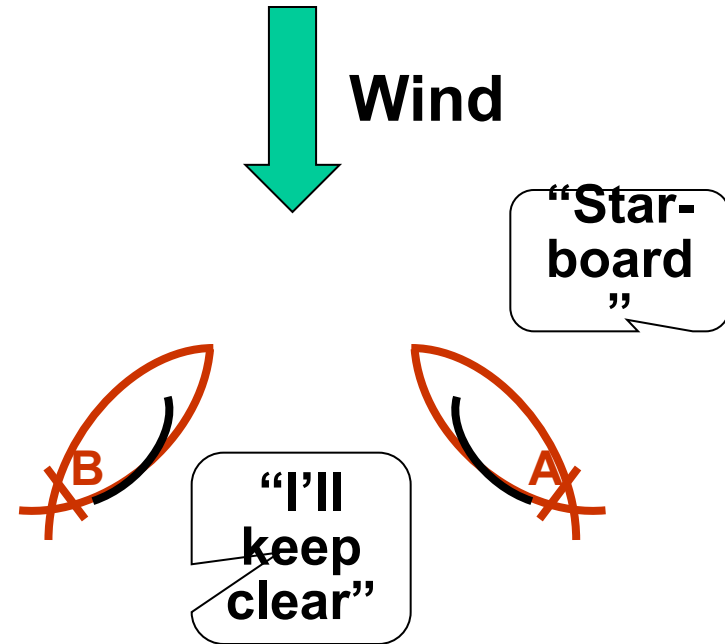

Boats may have additional obligations:

Rule 14: to avoid *contact*

Rule 15, 16 & 18: to give *room*

Rule 17: not to sail above / below *proper course*

What does Rule 18 Cover?

- Applies at *marks* and *obstructions*
- Designed to enable boats to go round *marks & obstructions* without risk of contact
- Usually requires outside boat to give inside boat *room* to pass the *mark* or *obstruction*
 - *Room* here is *room* “on the inside” & includes *room* to tack or gybe when part of manoeuvre
- Sometimes over-rides “normal” *right of way* rules

When does Rule 18 Apply?

Applies at a *mark* or *obstruction*:

- being left on the same side
- when boats are about to pass it
- until they both have passed it



It does NOT apply:

- at a starting *mark* when *starting*
- to boats on opposite tacks on a beat

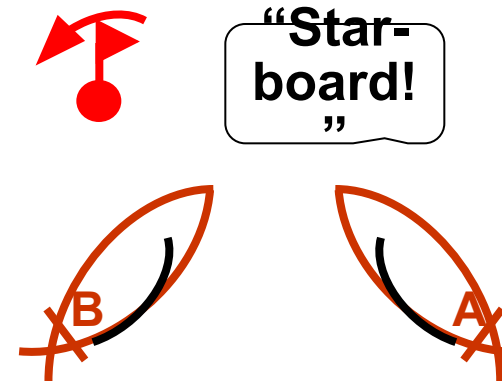

Rule 18.2: the Main Rule

- a When *overlapped*, outside boat at a *mark* shall give inside boat *room* **except that**:
- b if ***overlapped at 2 lengths***, outside boat must give *room* even if overlap then broken
 - and must also *keep clear* if she becomes astern or inside
- c if **one boat is *clear ahead at 2 lengths***, the other shall *keep clear* (and give *room* if later *overlapped*)
 - but if boat *clear ahead* tacks, this rule stops applying
- d and if right-of-way boat changes course to round a *mark*, rule 16 [altering course] does not apply

Rule 18.3: Special Tacking Rule

If: boats A & B were on opposite tacks

&: B completes a tack inside 2 lengths when A is fetching the *mark*

1 Rule 18.2 (previous slide) does not apply

2 B shall not

- cause A to sail above close-hauled to avoid her
- prevent A from passing the *mark*

3 B shall give *room* if A becomes *overlapped* inside her (& rule 15 [acquiring r-o-w] doesn't apply)

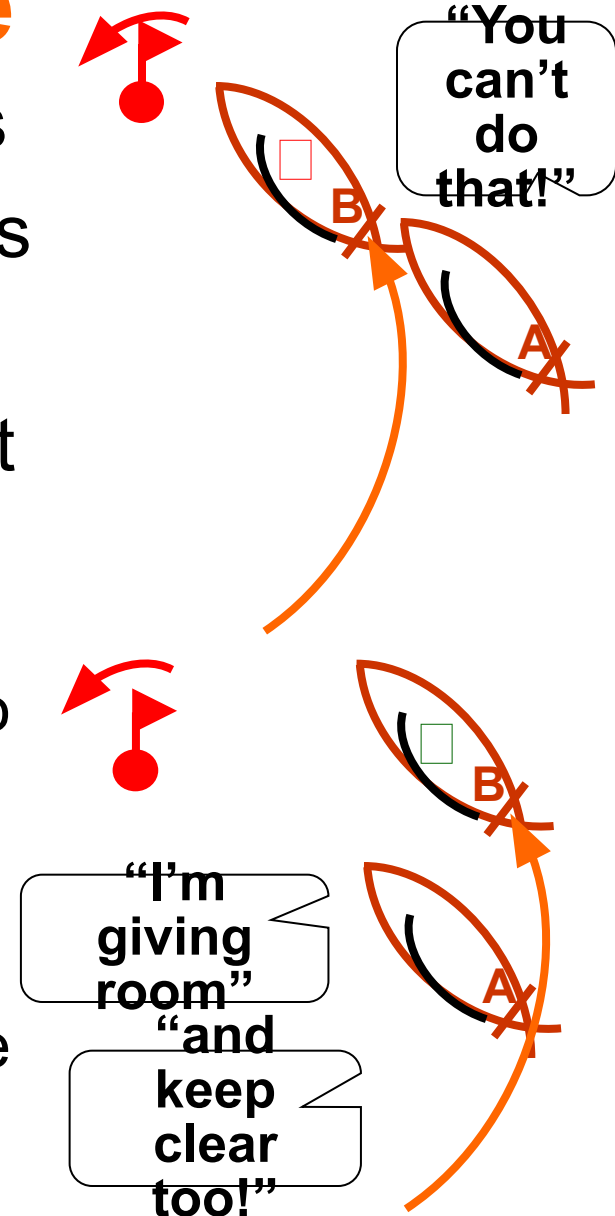

Rules 18.4 & 18.5: Other Provisions

Gybing

- When inside *overlapped* r-o-w boat must gybe at *mark* to sail her *proper course*, she must do so close to *mark*

Continuous Obstruction

- 2 length rules (18.2b & c) don't apply
- When boat astern establishes inside *overlap*
 - she is only entitled to *room* if there is *room* to pass at the moment the *overlap* is established
 - if not, she must *keep clear*

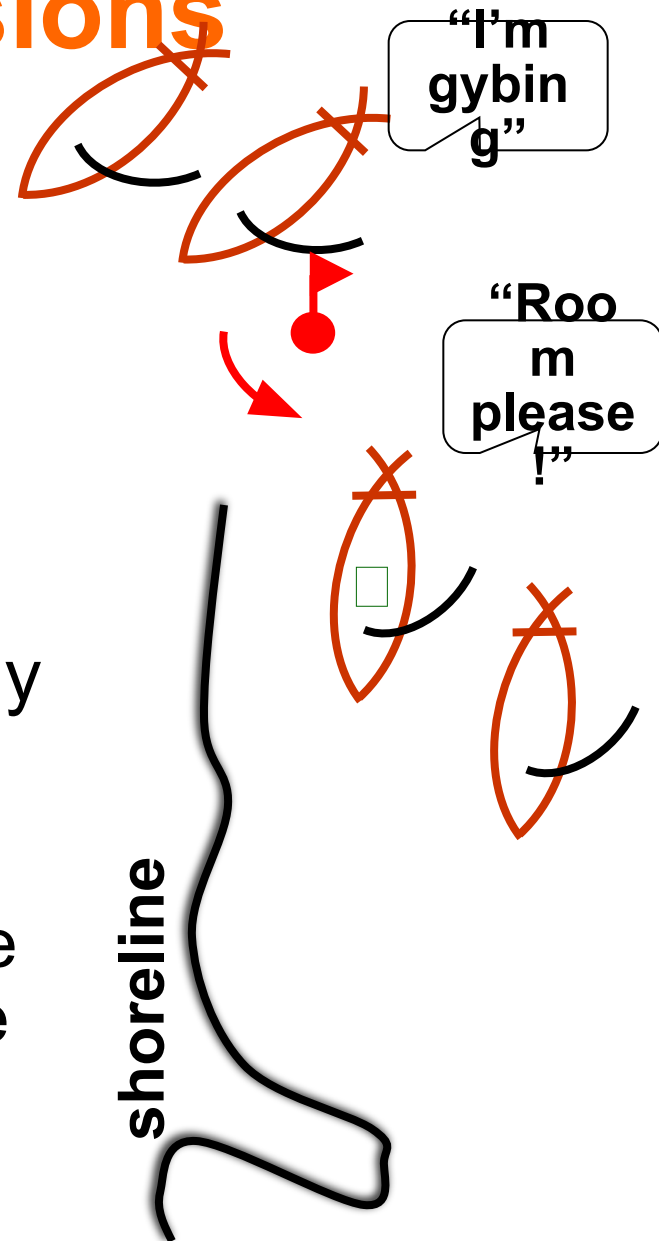

Rule 18 Summary

Easy, isn't it? 4 steps to heaven

- 1 Does rule 18 apply? Which paragraph?
- 2 Which boat has *right-of-way*?
 - as rule 18 sometimes over-rides normal r-o-w
- 3 Does outside boat have to give inside boat *room*?
- 4 Do other rules apply - 14, 15, 16, 17?

Now for the workshop exercises - pick to suit standard of audience!

Situation 1

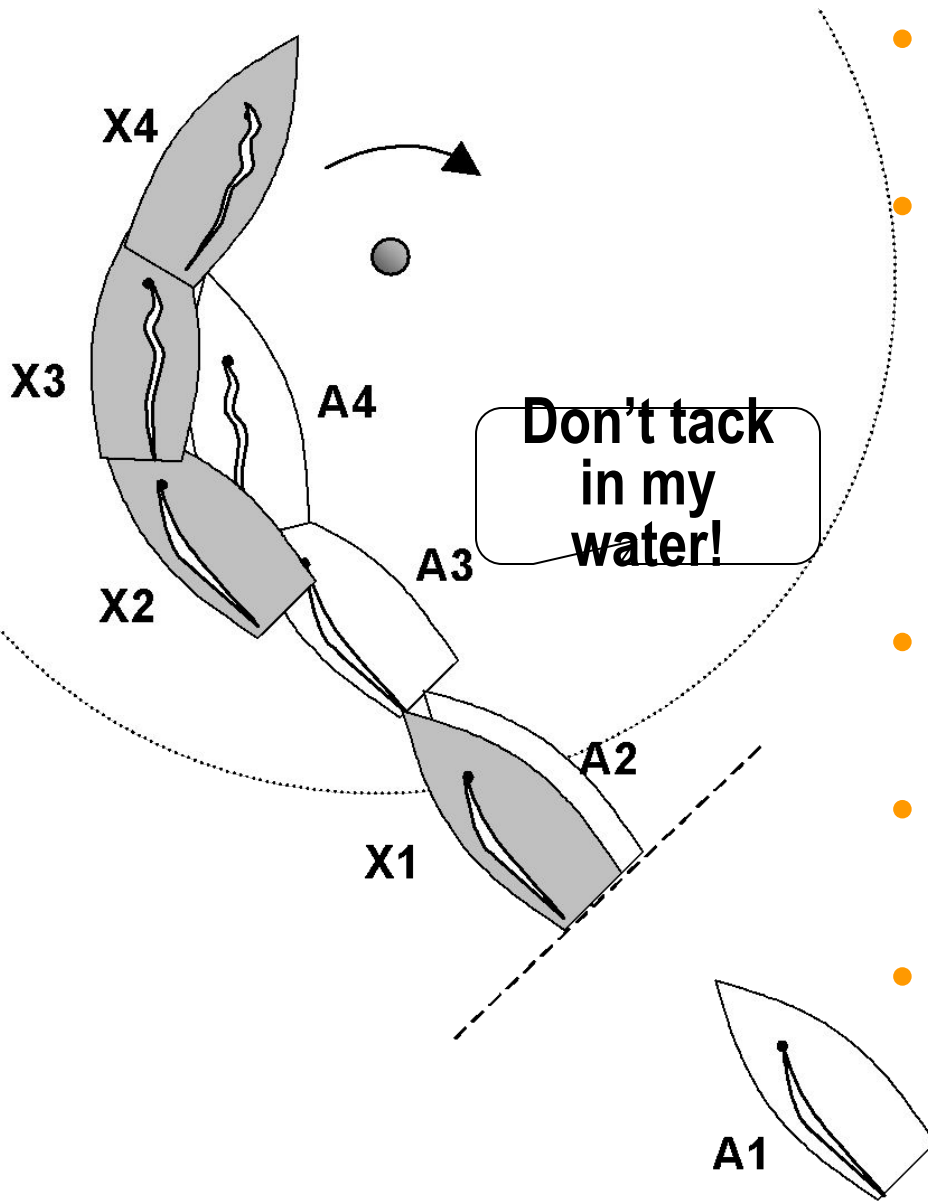

- When does rule 18 apply? **1 - 3: 18.2(c)**
- Which boat is r-o-w?
 - pos'n 1 **X**
 - pos'n 2 **X**
 - pos'n 3 **X**
 - pos'n 4 **A**
- Which boat has to give rule 18 room? **Neither**
- Does rule 16 or 17 apply? **16: A4**
- Decision: **Penalise A: A4 rule 16**

Situation 2

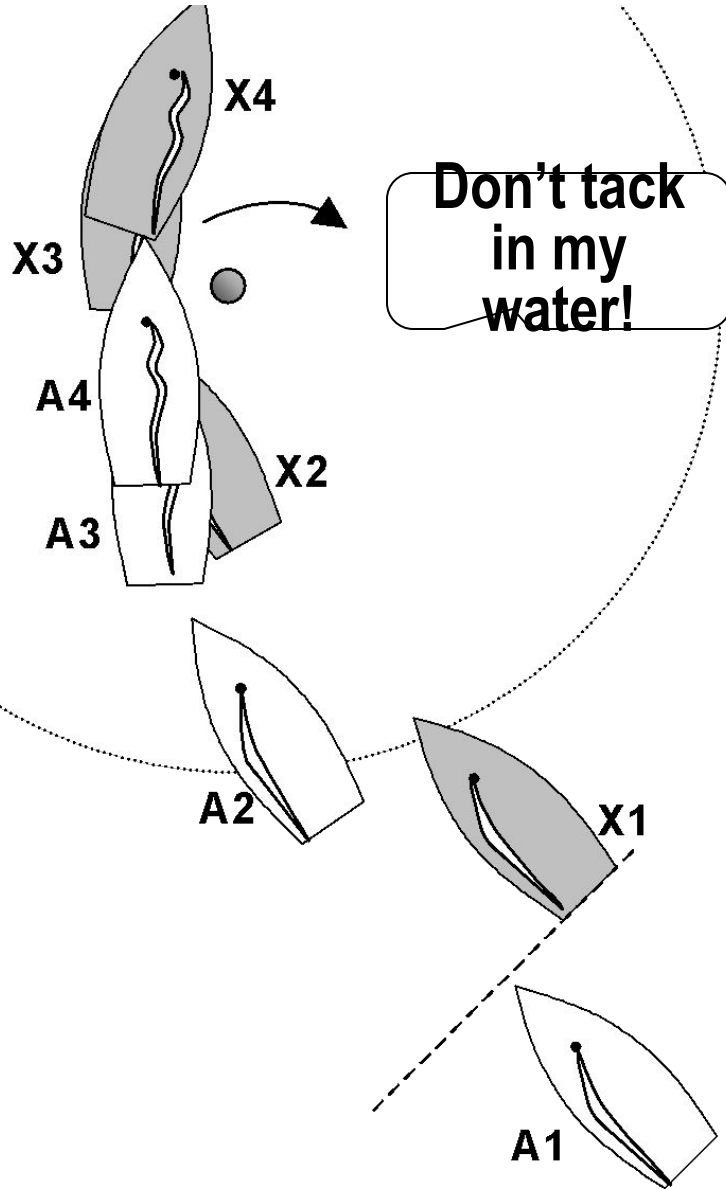

- When does rule 18 apply? **1 - 3: 18.2(c)**
- Which boat is r-o-w?
 - pos'n 1 **X**
 - pos'n 2 **X**
 - pos'n 3 **X**
 - pos'n 4 **A**
- Which boat has to give rule 18 room? **Neither**
- Does rule 16 or 17 apply? **No**
- Decision: **Penalise X:
X4 rule 13**

Situation 3

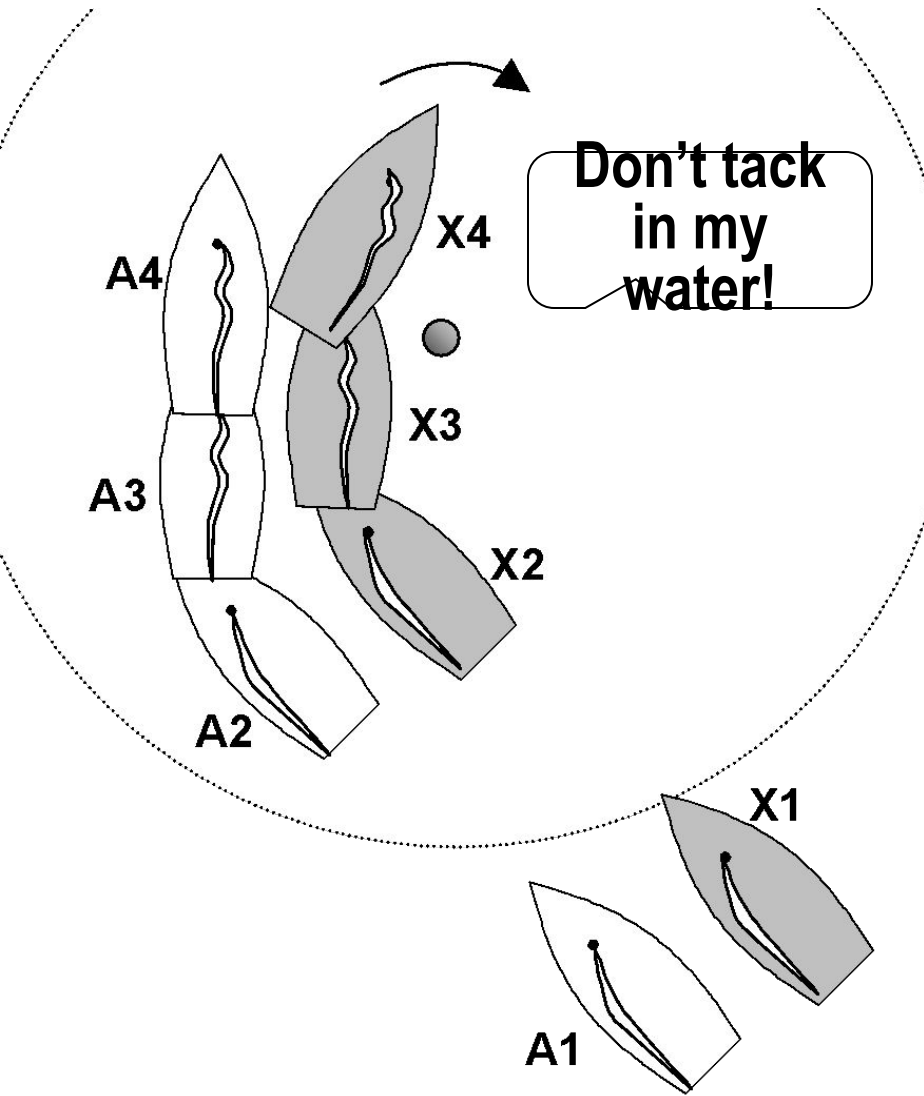

- When does rule 18 apply?
- Which boat is r-o-w?
 - pos'n 1
 - pos'n 2
 - pos'n 3
 - pos'n 4
- Which boat has to give rule 18 room?
- Does rule 16 or 17 apply?
- Decision:

Situation 4

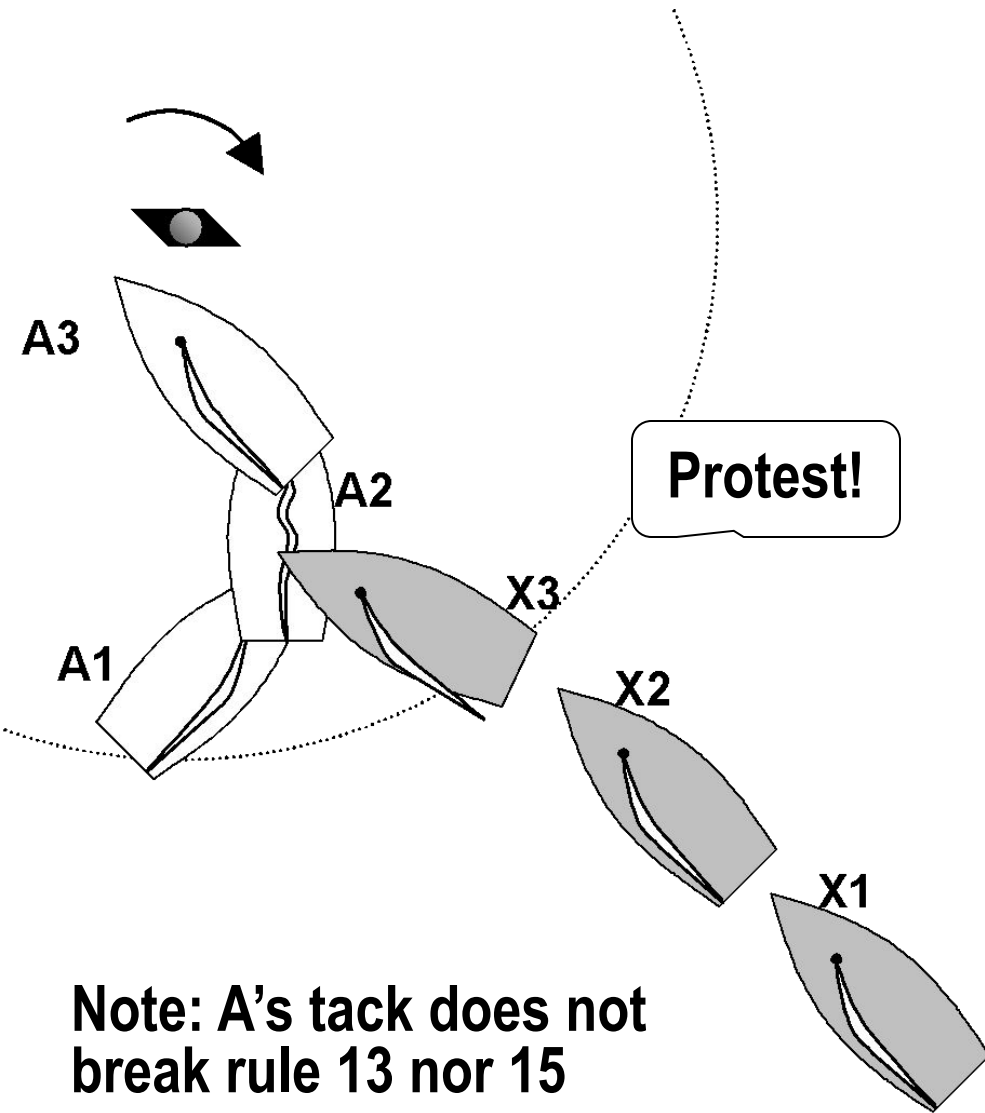

- When does rule 18 apply?
 - pos'n 1
 - pos'n 2
 - pos'n 3
- Which boat is r-o-w?
- Which boat has to give rule 18 room?
- Does rule 16 or 17 apply?
- Decision:

Situation 5

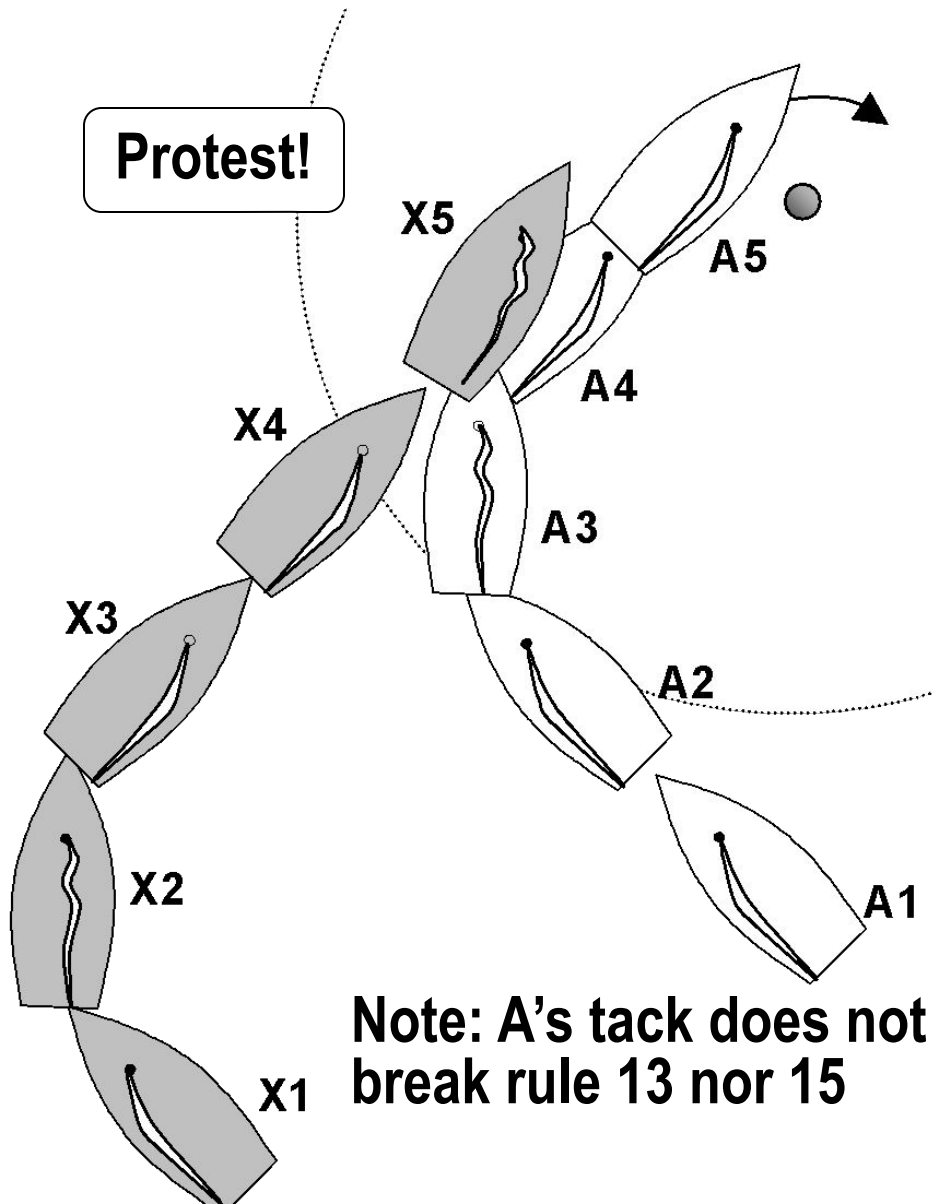

When does rule 18 apply?

Which boat is r-o-w?

- pos'n 1
- pos'n 2
- pos'n 3
- pos'n 4
- pos'n 5

• Which boat has to give rule 18 room?

• Does rule 16 or 17 apply?

• Decision:

Situation 6

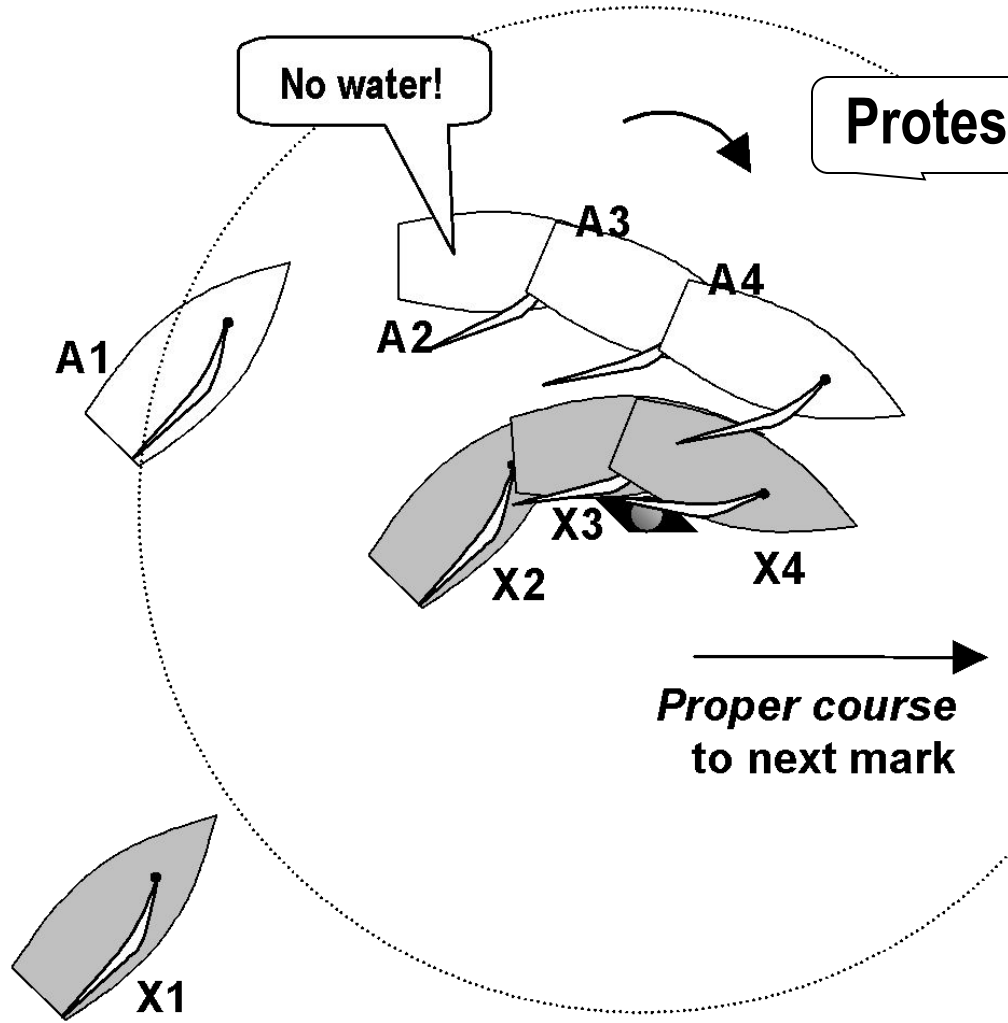

- When does rule 18 apply?
- Which boat is r-o-w?
 - pos'n 1
 - pos'n 2
 - pos'n 3
 - pos'n 4
- Which boat has to give rule 18 room?
- Does rule 16 or 17 apply?
- Decision:

Situation 7

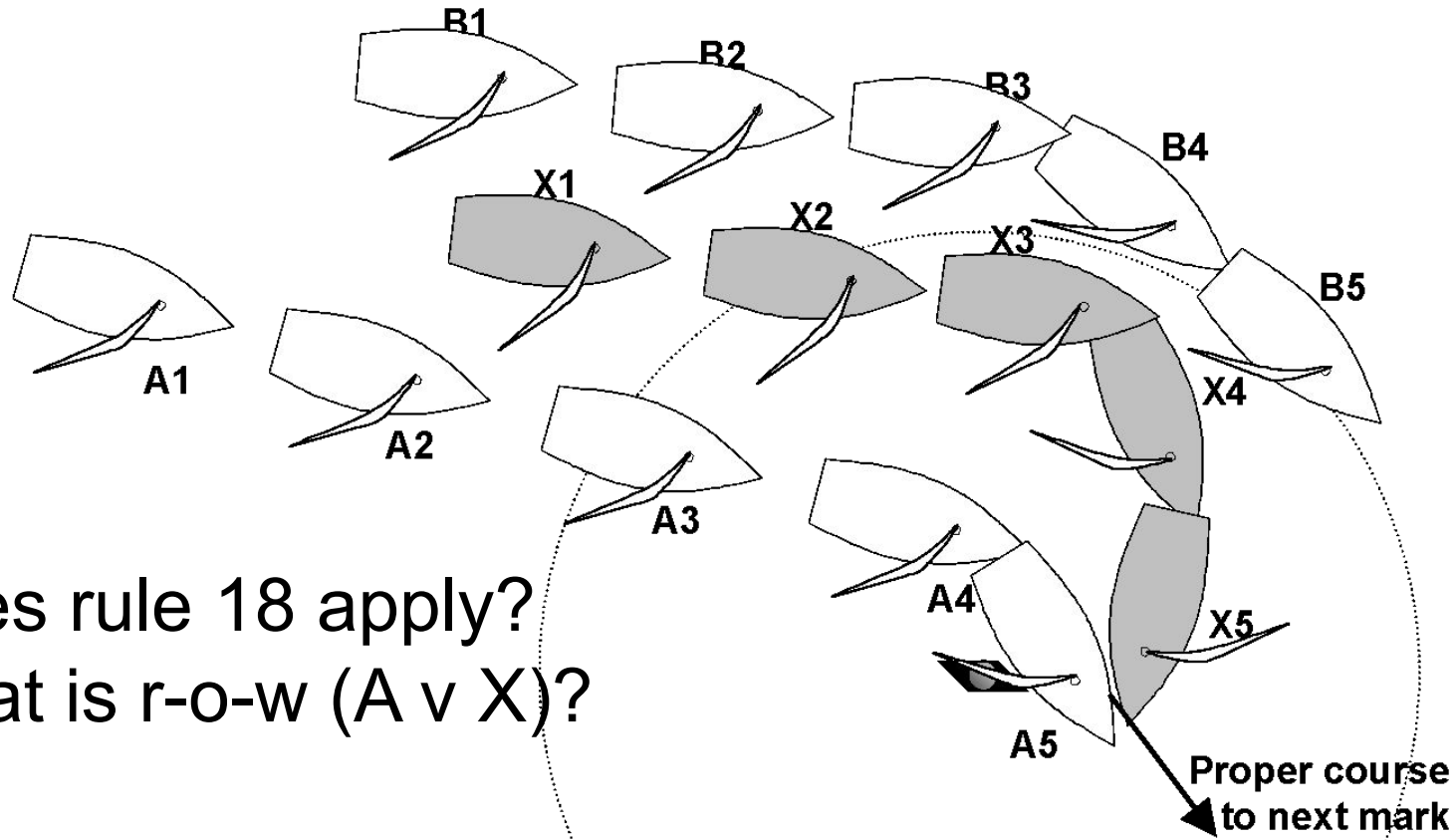

- When does rule 18 apply?
- Which boat is r-o-w (A v X)?
 - pos'n 1
 - pos'n 2
 - pos'n 3
 - pos'n 4
 - pos'n 5
- Does rule 16 or 17 apply?
- Decision:
- Which boat has to give rule 18 room?

Situation 8

- When does rule 18 apply?
- Which boat is r-o-w?
 - pos'n 1
 - pos'n 2
 - pos'n 3
- Which boat has to give rule 18 room?
- Does rule 16 or 17 apply?
- Decision:

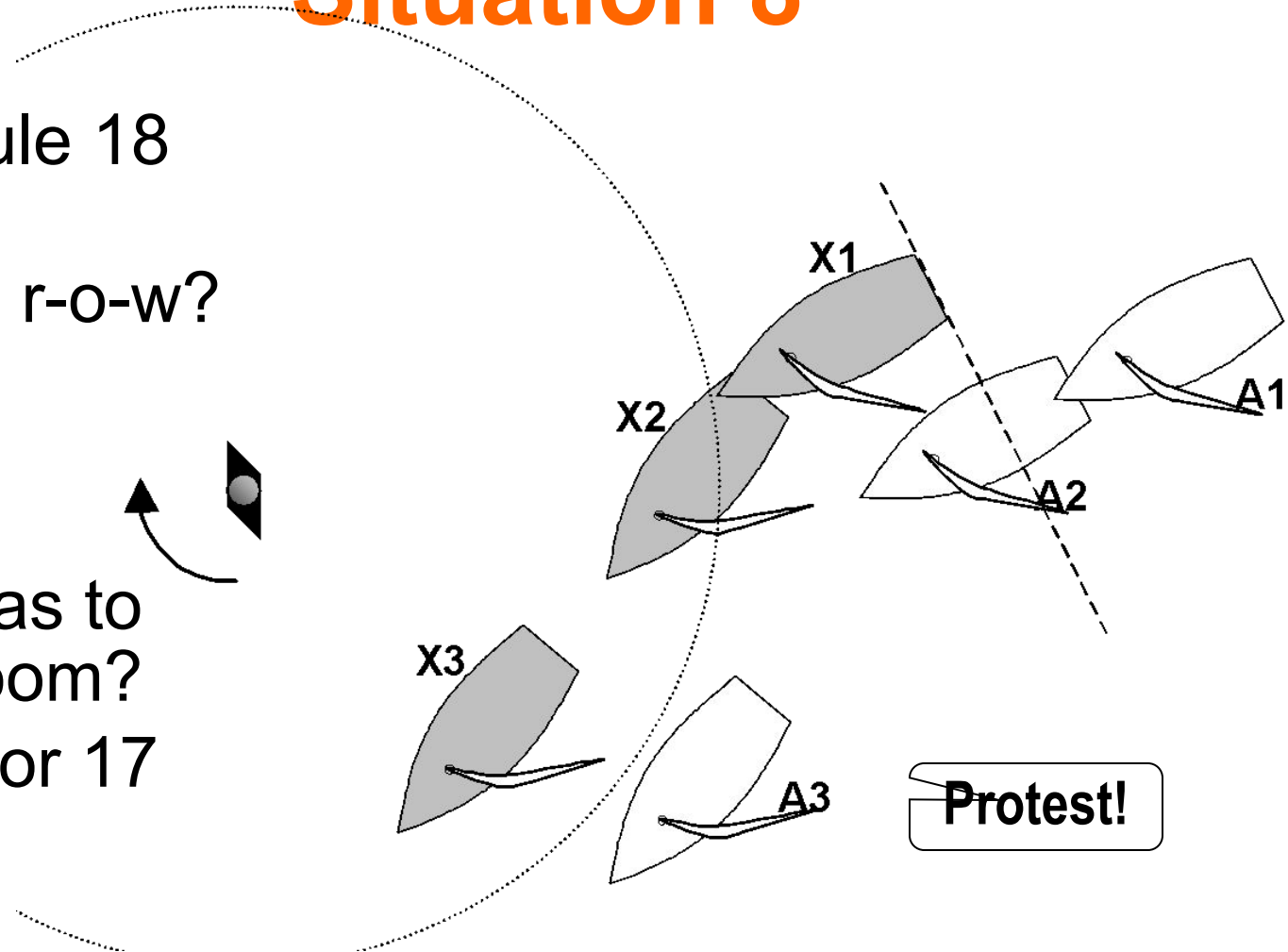

Situation 9

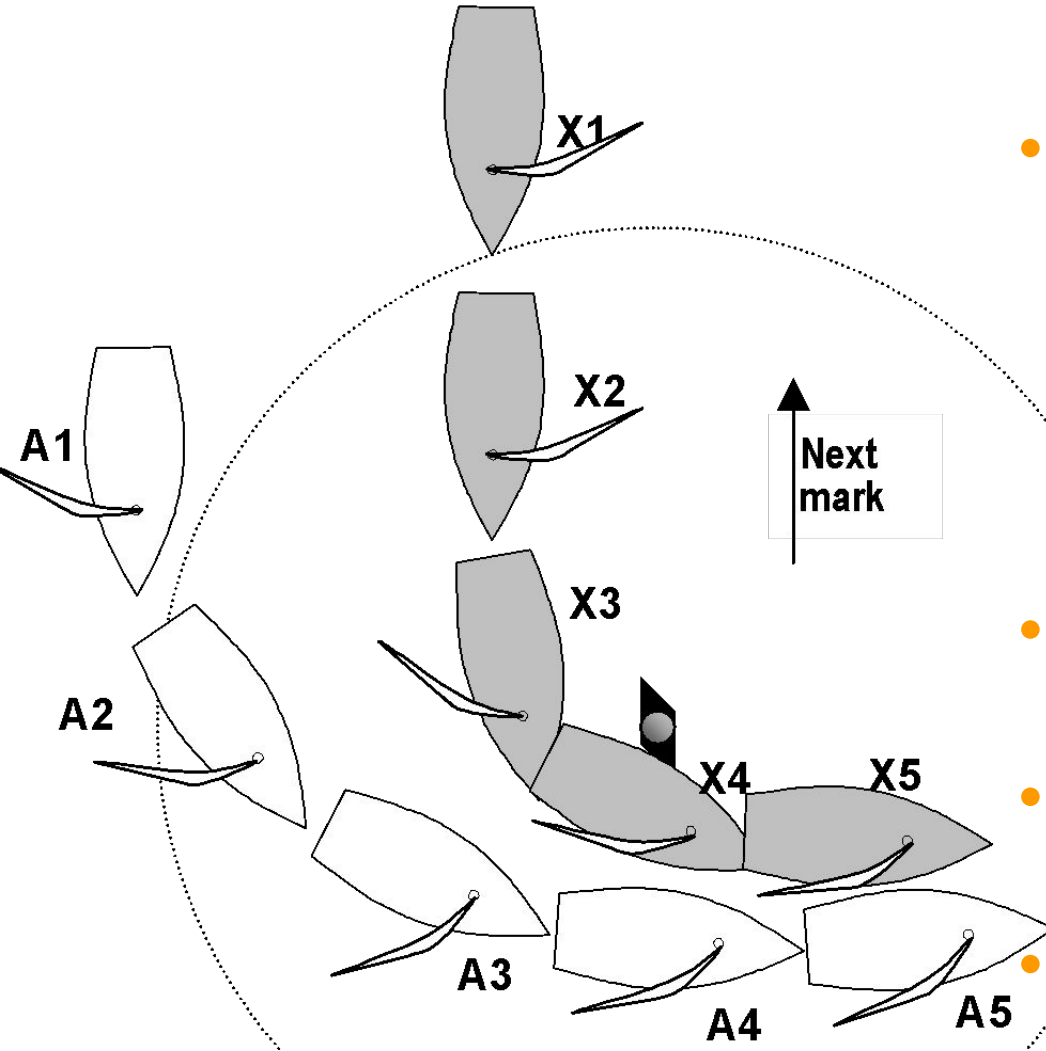

- When does rule 18 apply?
- Which boat is r-o-w?
 - pos'n 1
 - pos'n 2
 - pos'n 3
 - pos'n 4
 - pos'n 5
- Which boat has to give rule 18 room?
- Does rule 16 or 17 apply?
- Decision:

Situation 11

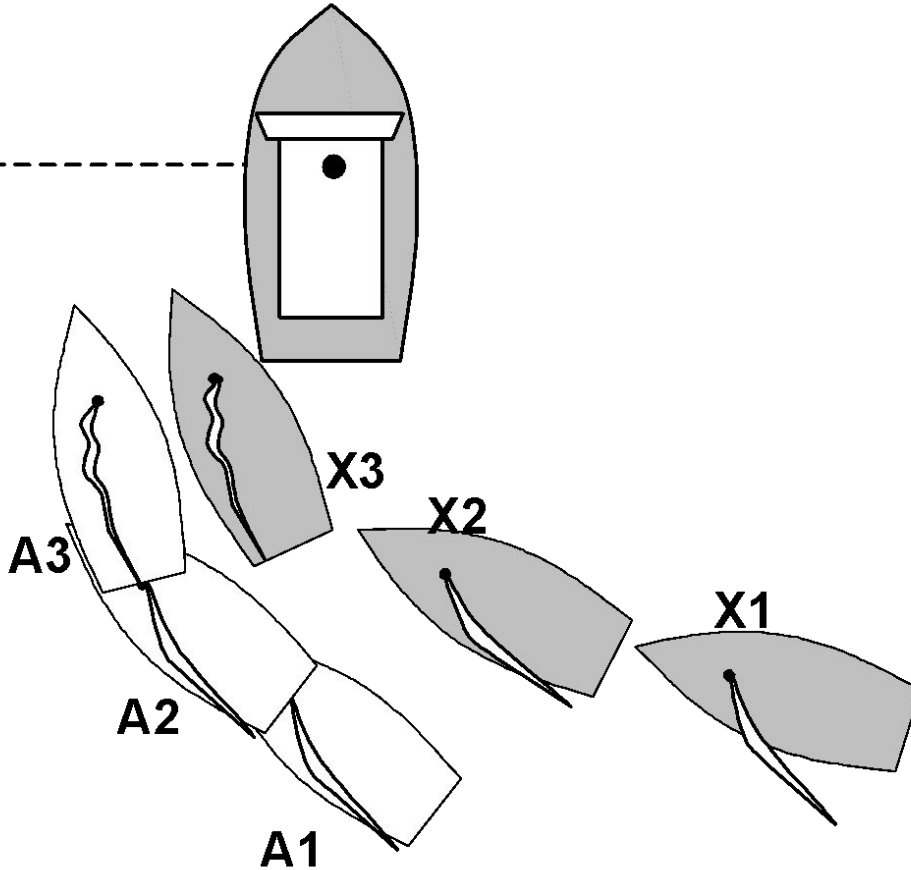

**Boats are approaching
the line to start**

- When does rule 18 apply?
- Which boat is r-o-w?
 - pos'n 1
 - pos'n 2
 - pos'n 3
- Which boat has to give rule 18 room?
- Does rule 16 or 17 apply?
- Decision:

Situation 12

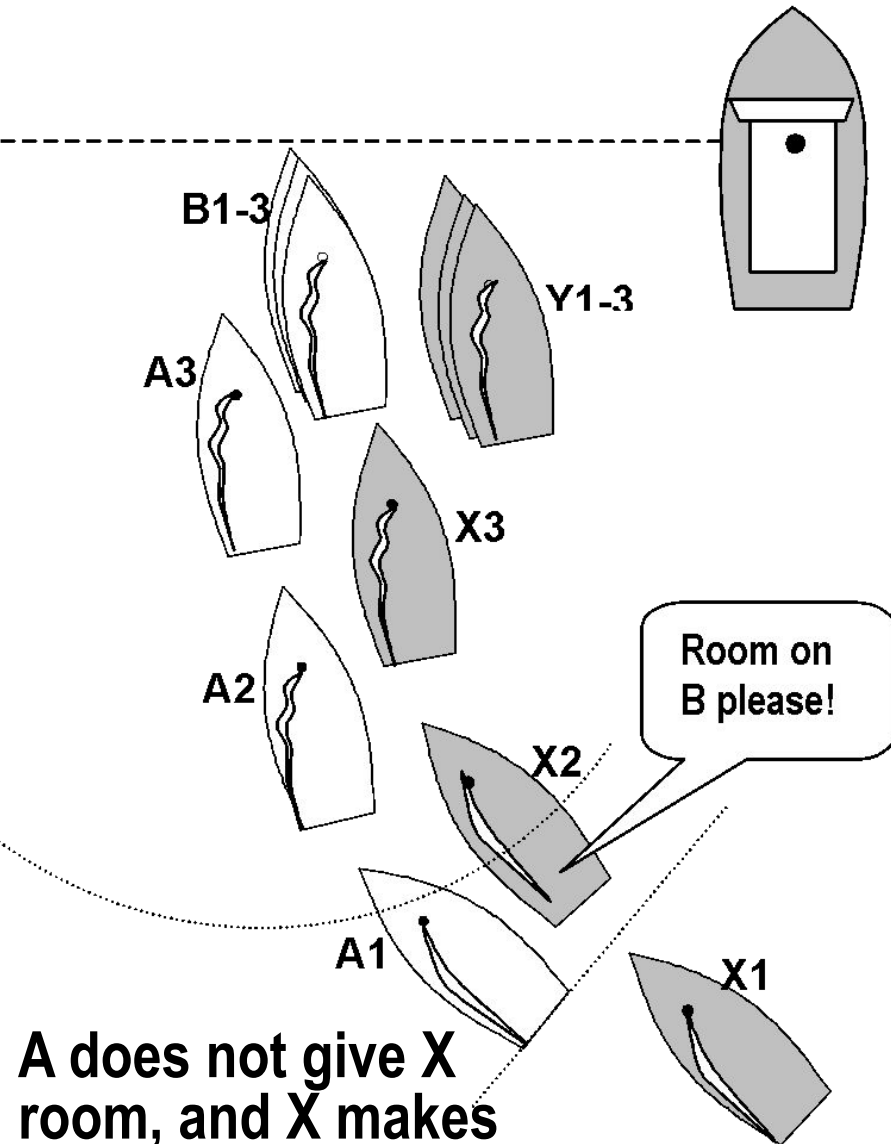

- When does rule 18 apply?
- Which boat is r-o-w?
 - pos'n 1
 - pos'n 2
 - pos'n 3
- Which boat has to give rule 18 room?
- Does rule 16 or 17 apply?
- Decision:

A does not give X room, and X makes contact with B's stern

Guidelines for Deciding Situations

- The following situations are quite tricky - choose situations to suit audience standard
- The situations are shown diagrammatically only ...
- ... therefore the information is incomplete & your decision may depend on other data (eg wind strength, type of boat) that you would ascertain at the hearing
- While rule 14 may apply, do not include rule 14 in your consideration
- “New math” - it’s not the answer that counts!

(after Tom Lehrer)

Situation 10

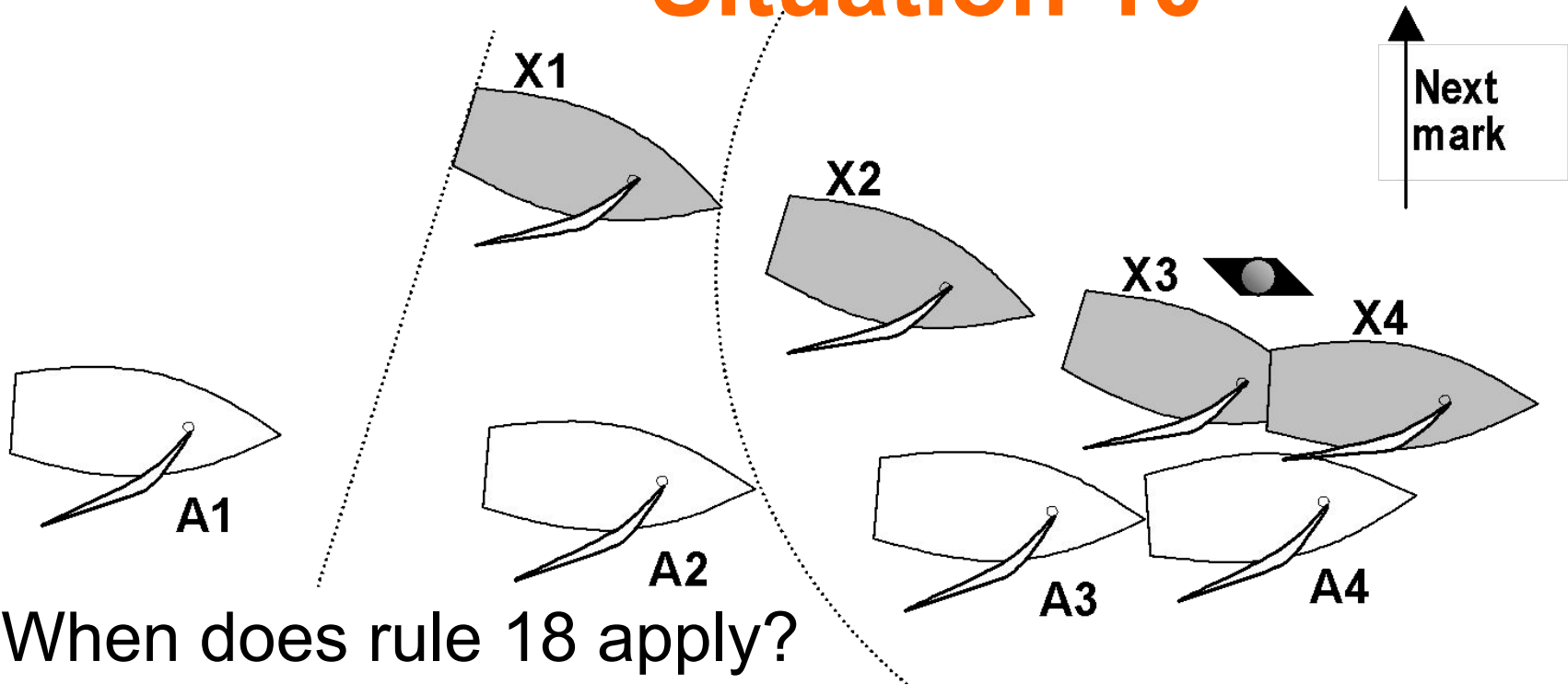

- When does rule 18 apply?
- Which boat is r-o-w (A v X)?
 - pos'n 1
 - pos'n 2
 - pos'n 3
 - pos'n 4
- Does rule 16 or 17 apply?
- Decision:
- Which boat has to give rule 18 room?

Situation 14

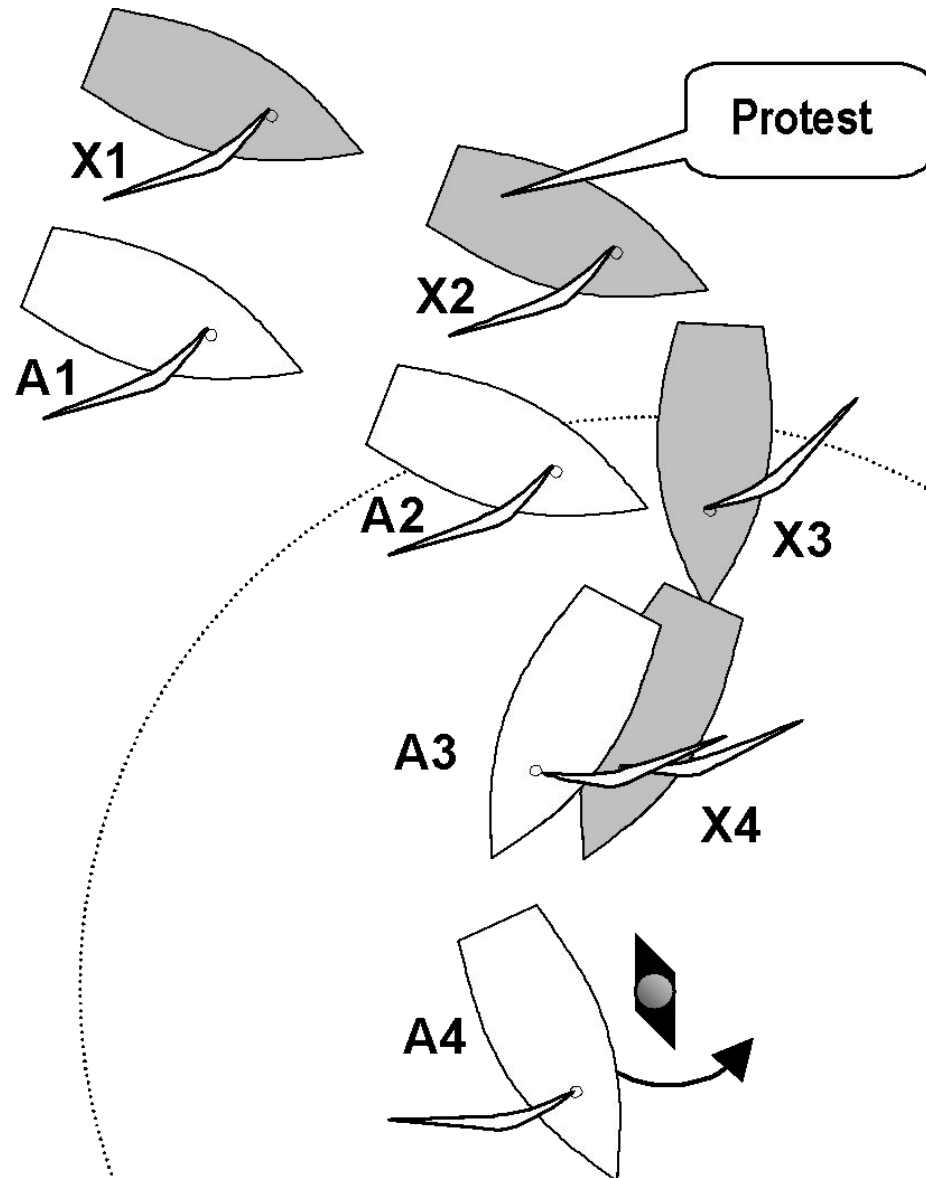

- When does rule 18 apply?
- Which boat is r-o-w?
 - pos'n 1
 - pos'n 2
 - pos'n 3
 - pos'n 4
- Which boat has to give rule 18 room?
- Does rule 16 or 17 apply?
- Decision:

Situation 13(a)

Both sides of Z are proper courses for X

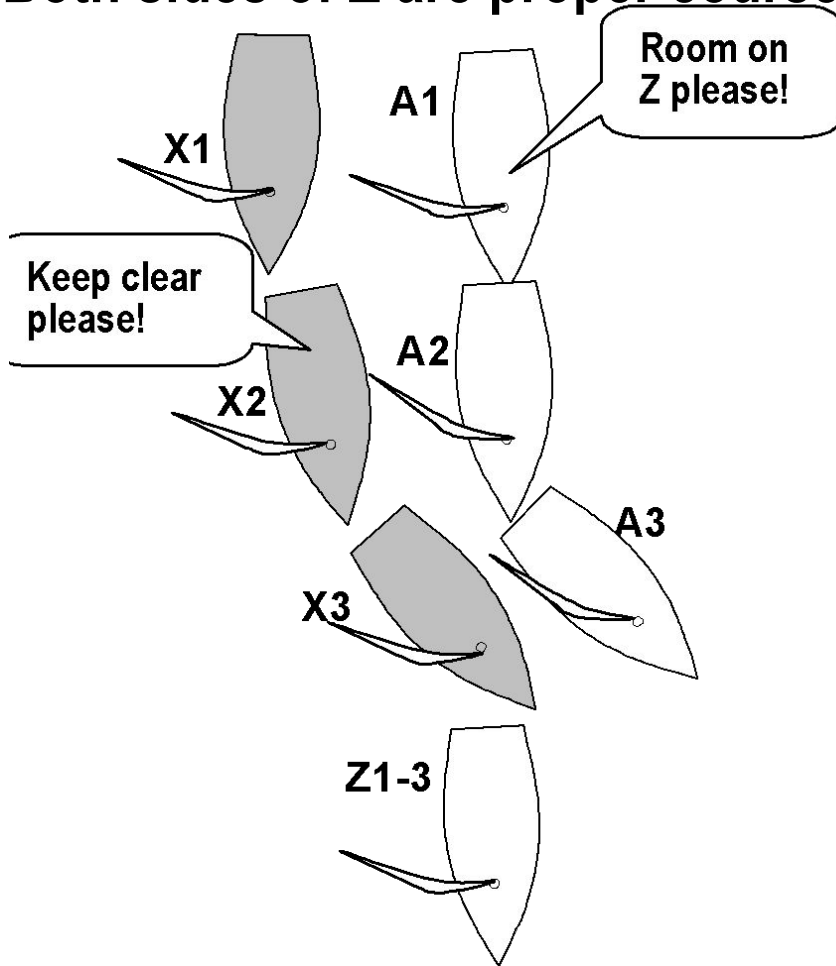

- When does rule 18 apply?
- Which boat (A v X) is r-o-w?
 - pos'n 1
 - pos'n 2
 - pos'n 3
- Which boat has to give rule 18 room?
- Does rule 16 or 17 apply?
- Decision:

Z is moving forward slowly - for simplicity the diagram shows relative positions of A and X with respect to Z at 1, 2 and 3

Situation 15(13 b & c)

Does the answer change if Z is in either of these positions?

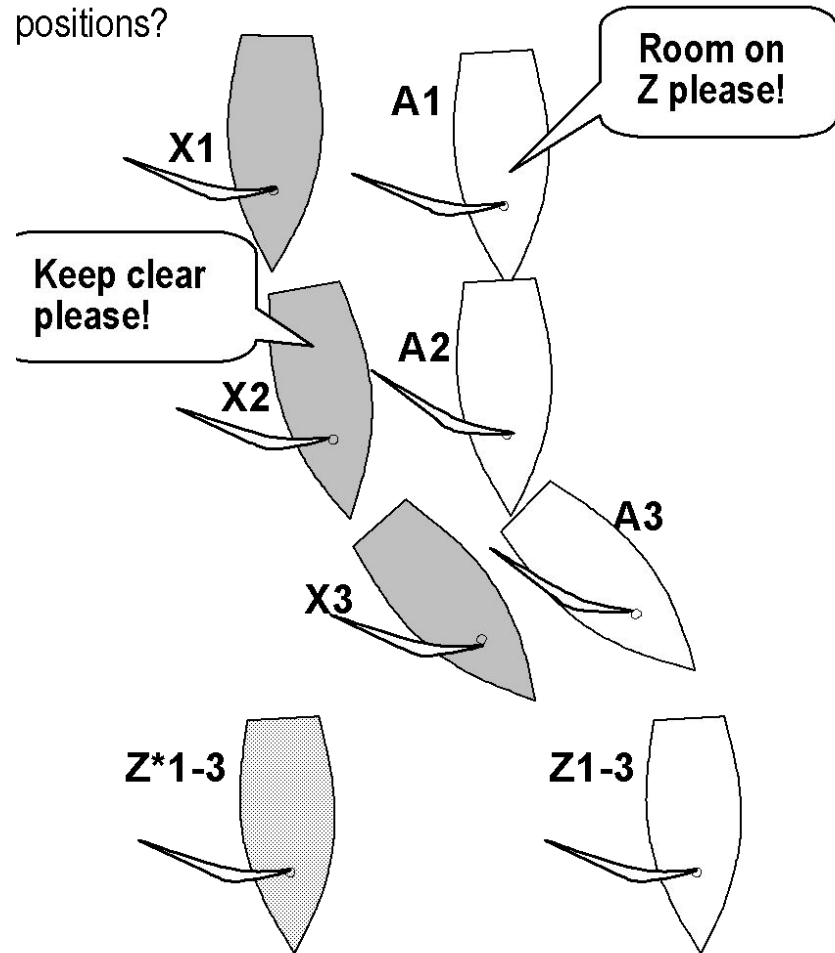

- When does rule 18 apply?
 - pos'n 1
 - pos'n 2
 - pos'n 3
- Which boat (A v X) is r-o-w?
- Which boat has to give rule 18 room?
- Does rule 16 or 17 apply?
- Decision:

Z is moving forward slowly - for simplicity the diagram shows relative positions at 1, 2 and 3

Situation 16

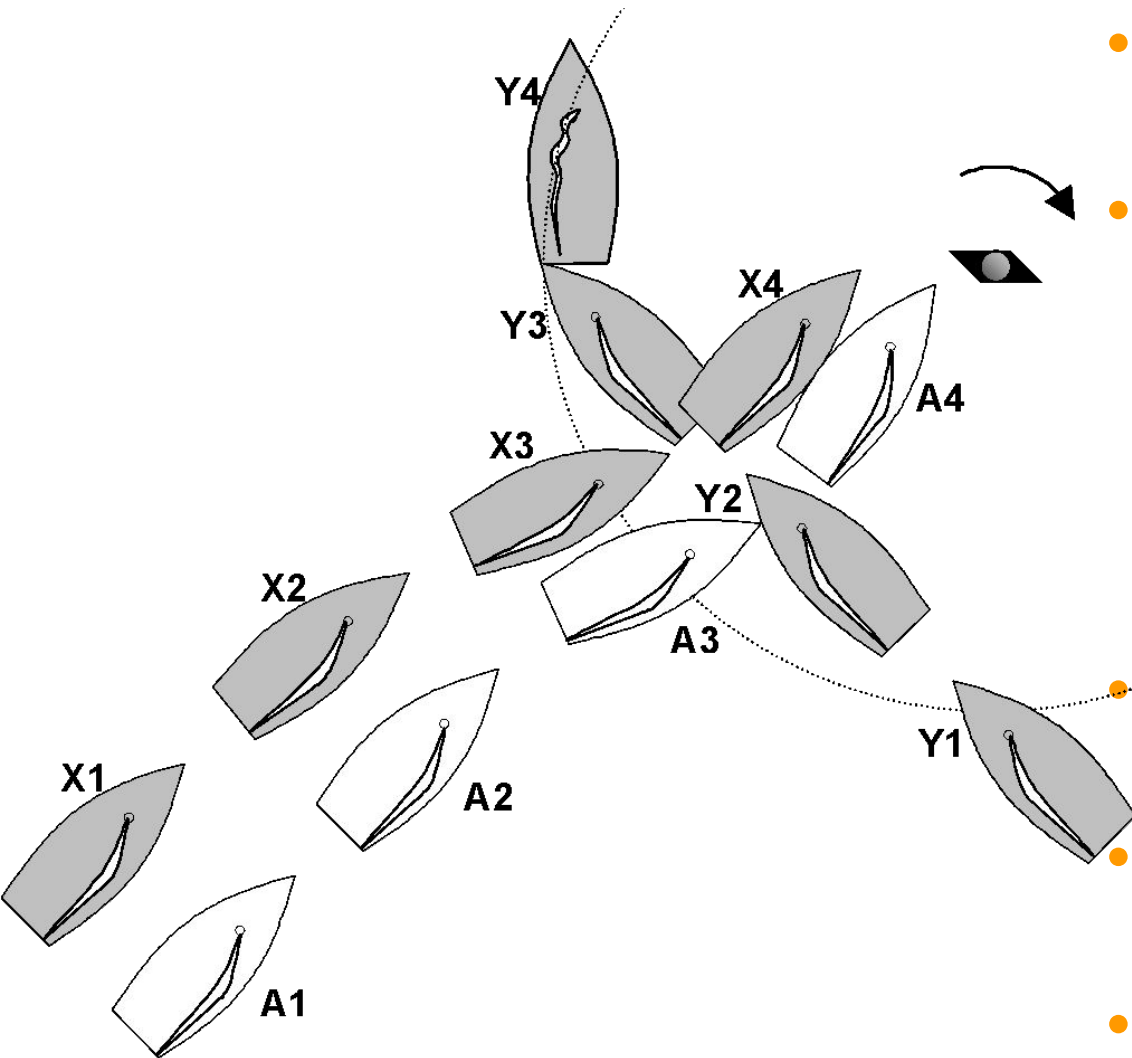

- When does rule 18 apply?
- Which boat (A v X) is r-o-w?
 - pos'n 1
 - pos'n 2
 - pos'n 3
 - pos'n 4
- Which boat has to give rule 18 room?
- Does rule 16 or 17 apply?
- Decision: