

*Решение простейших  
тригонометрических уравнений  
с помощью единичной окружности*

*10  
класс*



# Разминка

Записать с помощью формулы множество углов, соответствующих данным точкам

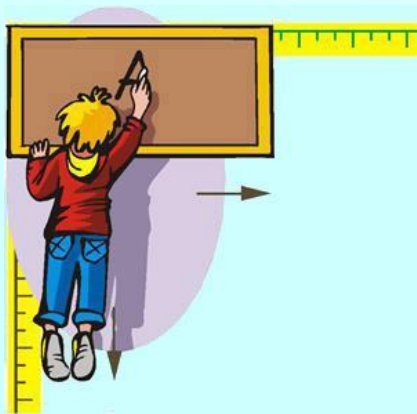
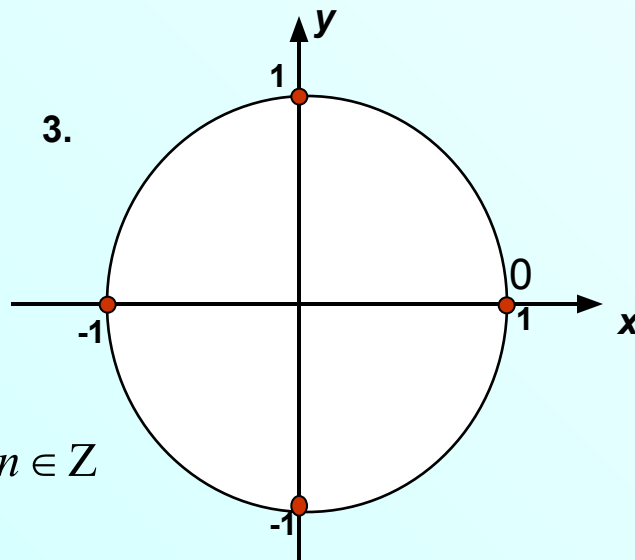
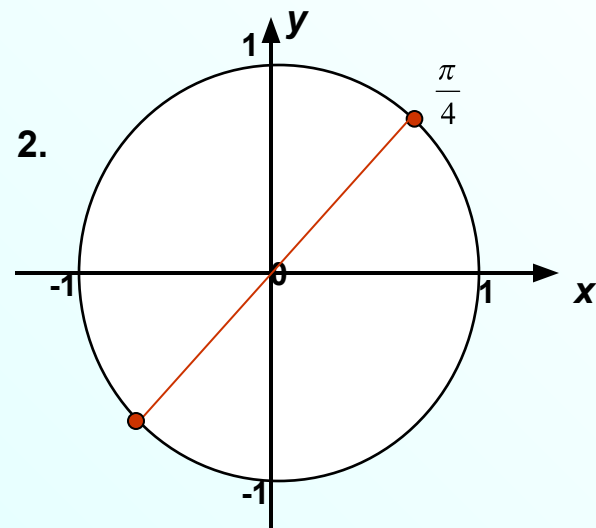
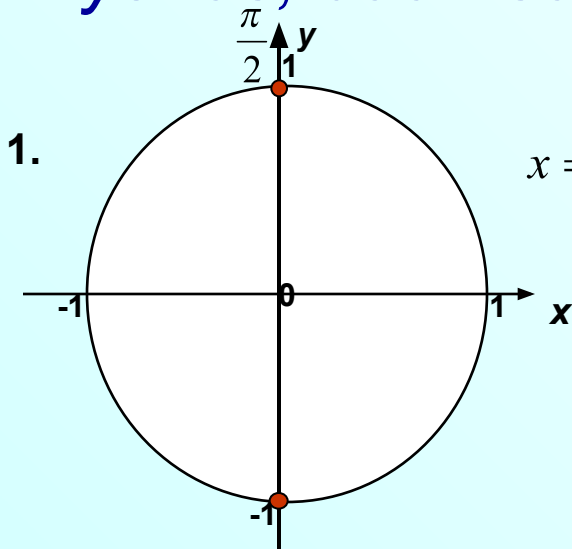



4.

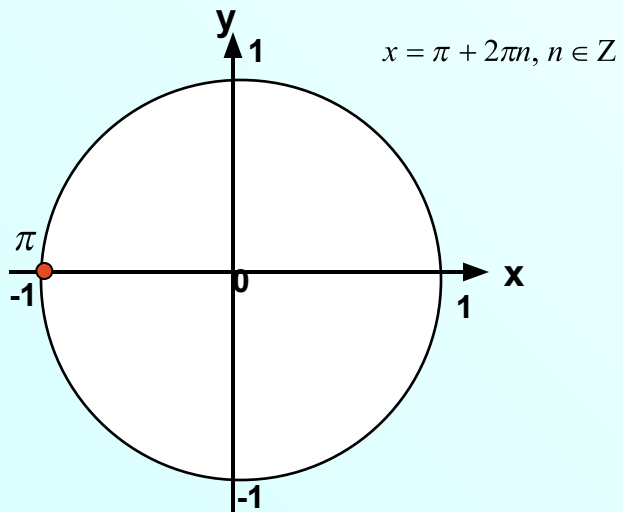

5.

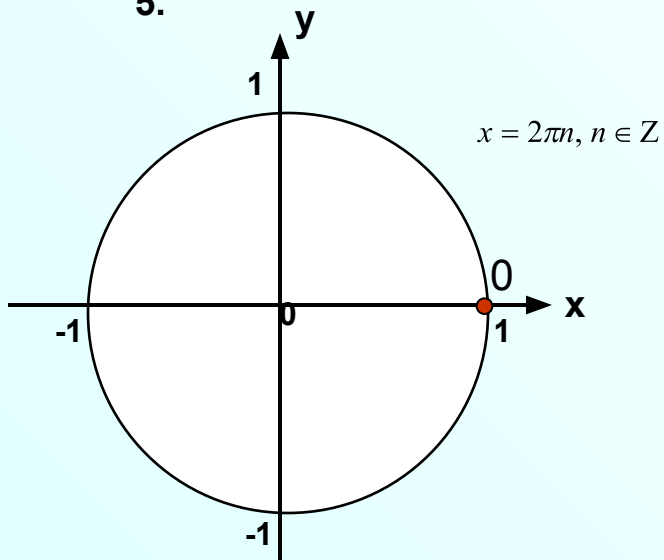

6.

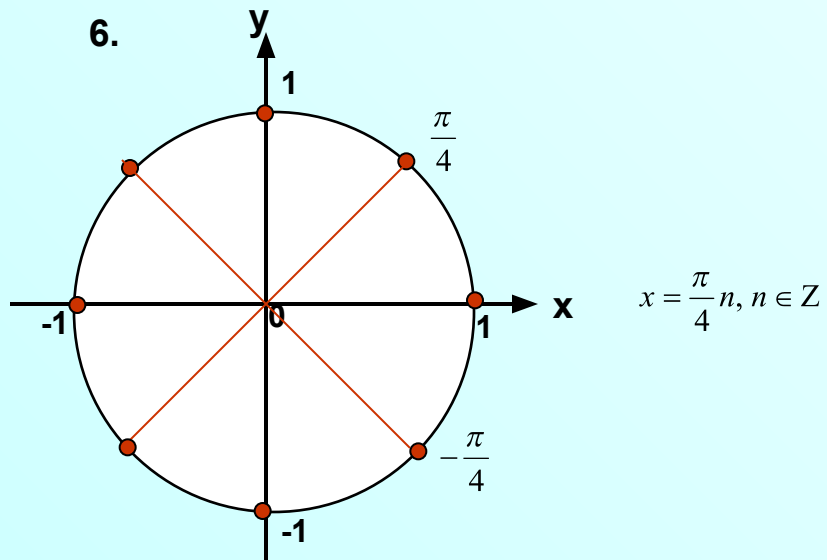

7.

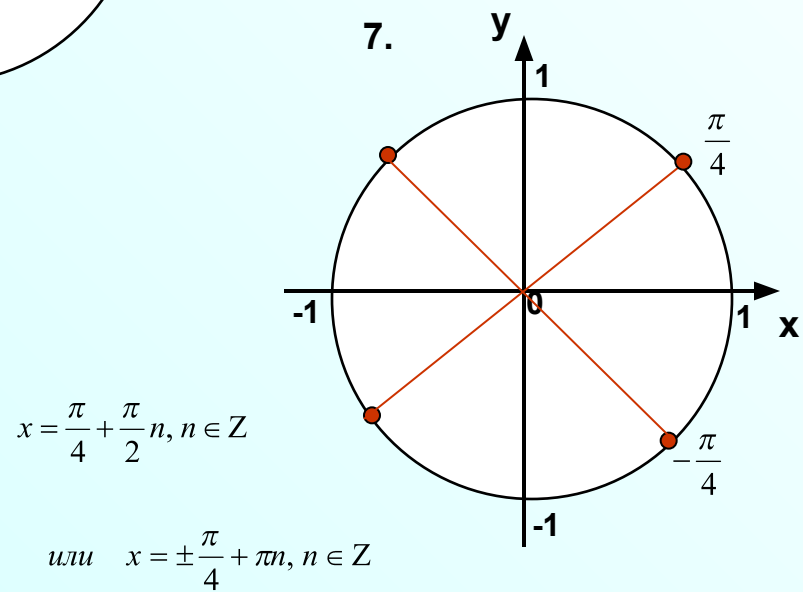

# Обратная задача: *отметить точками углы, соответствующие данным формулам*

1.

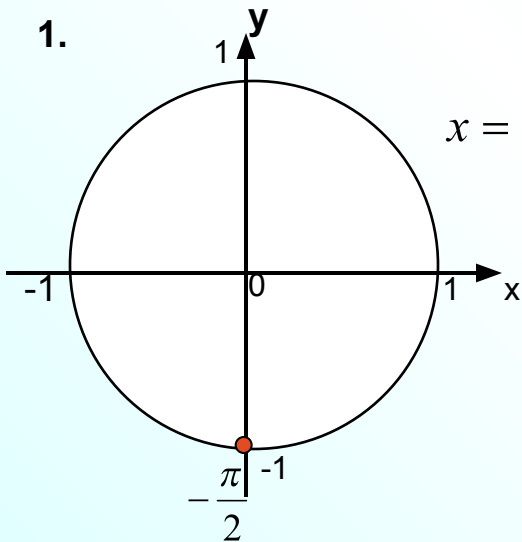

$$x = -\frac{\pi}{2} + 2\pi n, n \in \mathbb{Z}$$

2.

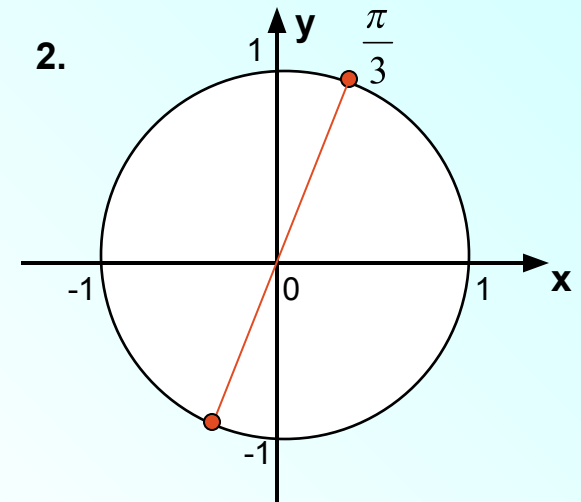

$$x = \frac{\pi}{3} + \pi n, n \in \mathbb{Z}$$

3.

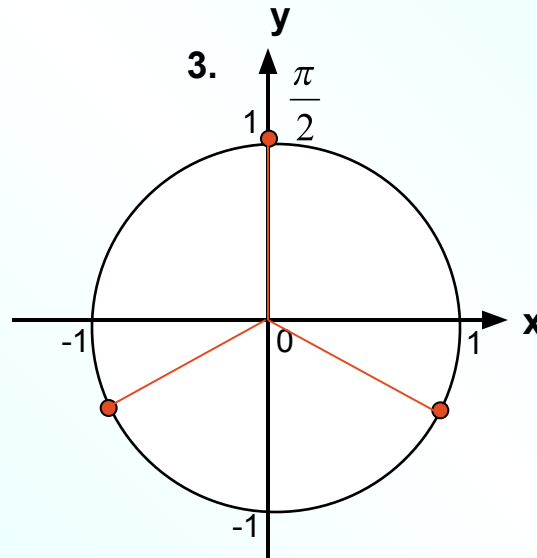

$$x = \frac{\pi}{2} + \frac{2\pi}{3} n, n \in \mathbb{Z}$$

4.

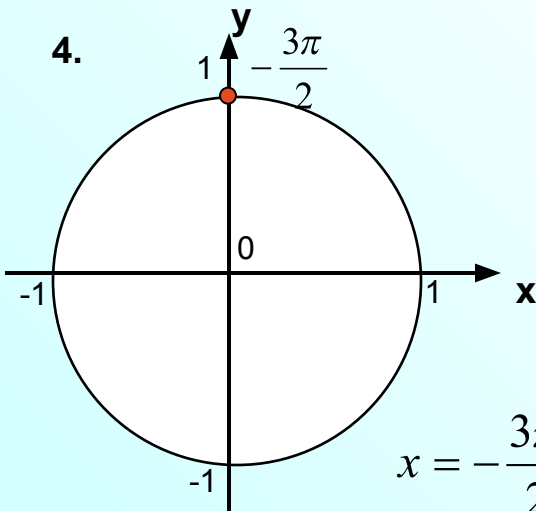

$$x = -\frac{3\pi}{2} + 2\pi n, n \in \mathbb{Z}$$



# Решить уравнения

1.

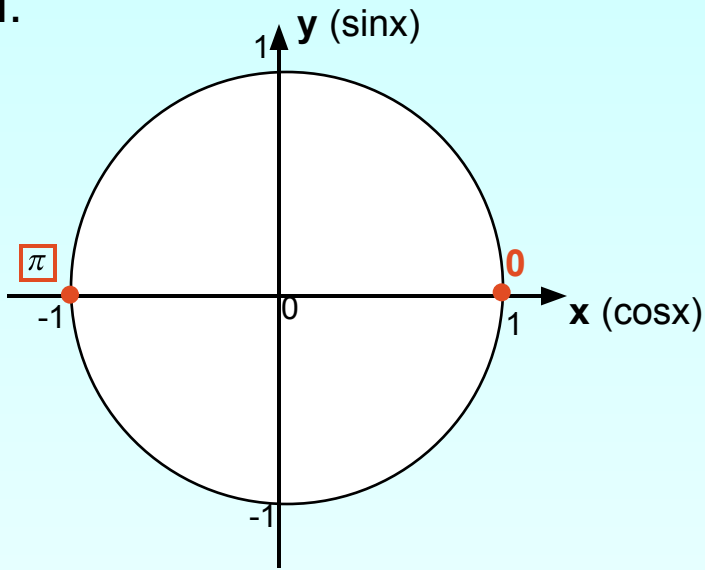

$$\sin x = 0$$

$$x = \pi n, n \in \mathbb{Z}$$

2.

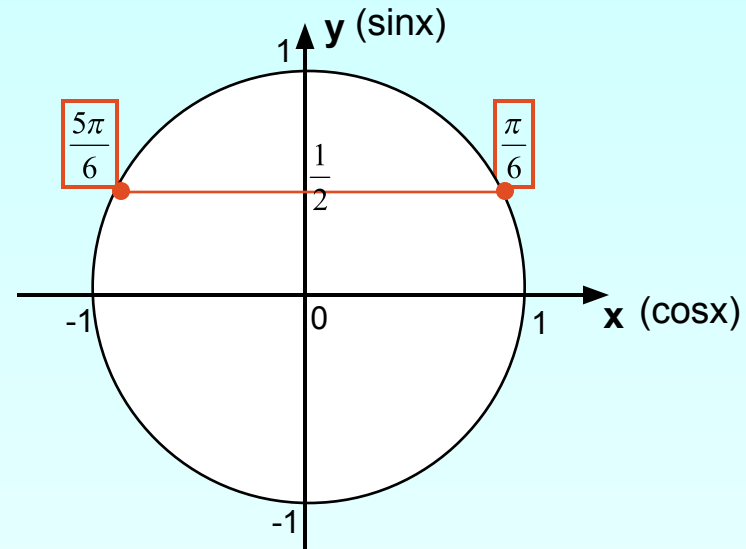

$$\sin x = \frac{1}{2}$$

$$\left[ \begin{array}{l} x = \frac{\pi}{6} + 2\pi n, n \in \mathbb{Z} \\ x = \frac{5\pi}{6} + 2\pi n, n \in \mathbb{Z} \end{array} \right.$$



$$3. \quad \cos^2 x = \frac{3}{4}$$

$$\cos x = \pm \frac{\sqrt{3}}{2}$$

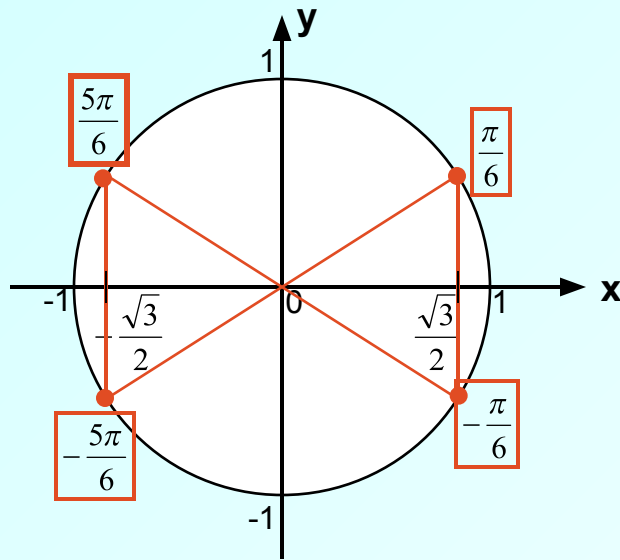

$$\left[ \begin{array}{l} x = \pm \frac{\pi}{6} + 2\pi n, n \in \mathbb{Z}; \\ x = \pm \frac{5\pi}{6} + 2\pi n, n \in \mathbb{Z}. \end{array} \right.$$

$$\left[ \begin{array}{l} x = \frac{\pi}{6} + \pi n, n \in \mathbb{Z}; \\ x = -\frac{\pi}{6} + \pi n, n \in \mathbb{Z}. \end{array} \right.$$

$$x = \pm \frac{\pi}{6} + \pi n, n \in \mathbb{Z}$$

$$\operatorname{tg}^2 x = 1$$

$$\operatorname{tg} x = \pm 1$$

$$x = \frac{\pi}{4} + \frac{\pi}{2}n, n \in \mathbb{Z}$$

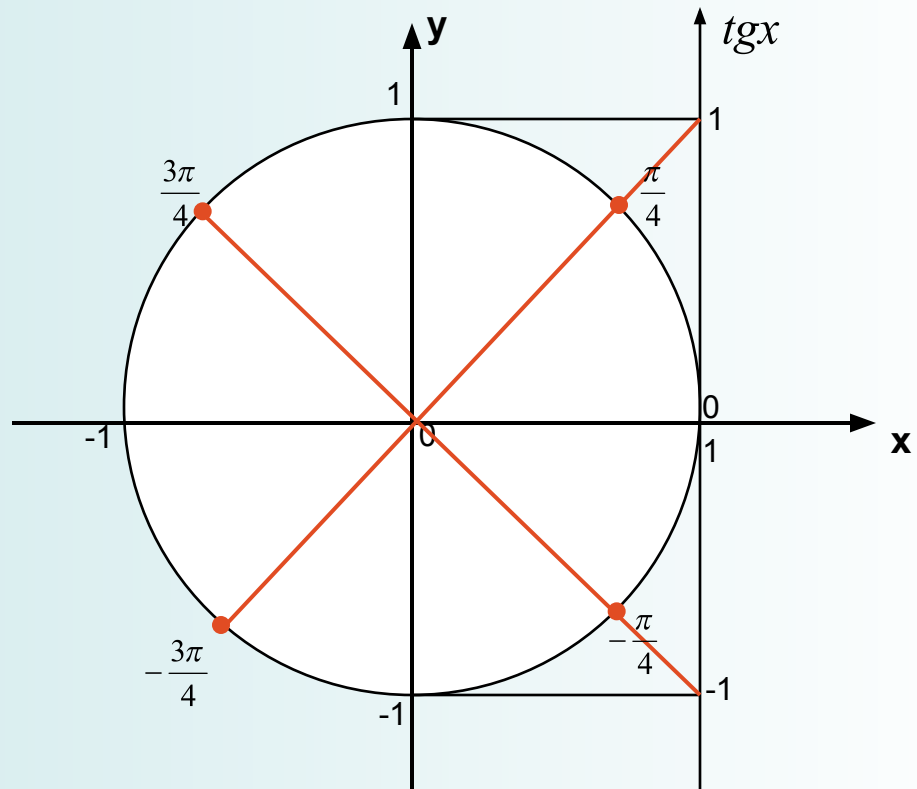

$$\operatorname{ctg} x = -\sqrt{3}, \text{ где } x \in [\pi; 2\pi]$$

$$x = -\frac{\pi}{6} + \pi n, n \in \mathbb{Z}$$

$$\frac{5\pi}{6} + \pi = \frac{11\pi}{6}$$

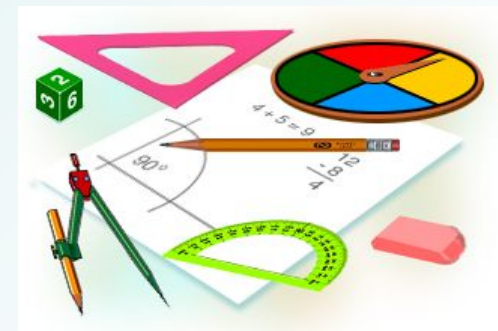
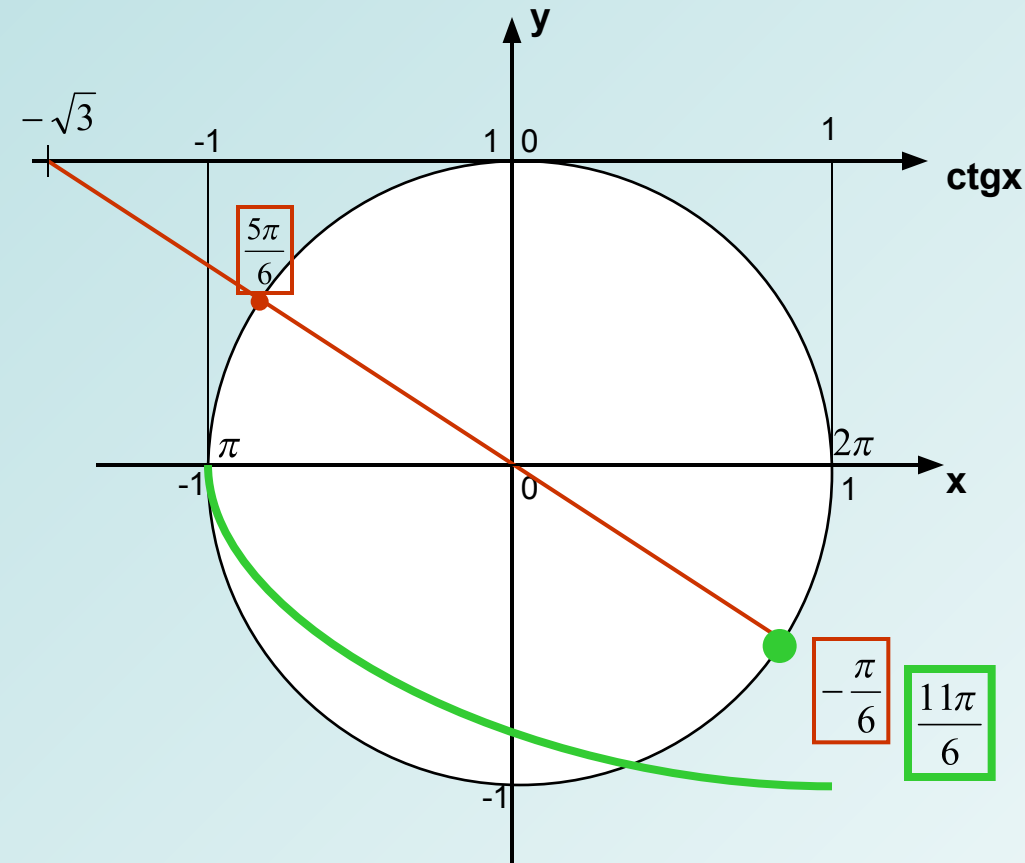



# Аналитический способ отбора корней из промежутка

$$x = -\frac{\pi}{6} + \pi n, n \in \mathbb{Z}$$

$$\pi \leq -\frac{\pi}{6} + \pi n \leq 2\pi, n \in \mathbb{Z};$$

$$7 \leq 6n \leq 13, n \in \mathbb{Z};$$

$$1 \leq -\frac{1}{6} + n \leq 2, n \in \mathbb{Z};$$

$$1\frac{1}{6} \leq n \leq 2\frac{1}{6}, n \in \mathbb{Z};$$

$$6 \leq -1 + 6n \leq 12, n \in \mathbb{Z}; \quad n = 2; \quad x = -\frac{\pi}{6} + 2\pi = \frac{11\pi}{6}$$

ОТВЕТ:  $\frac{11\pi}{6}$

$$\frac{\sin x - \frac{\sqrt{3}}{2}}{\cos x + \frac{1}{2}} = 0$$

$$\begin{cases} \sin x = \frac{\sqrt{3}}{2}; \\ \cos x \neq -\frac{1}{2}. \end{cases}$$

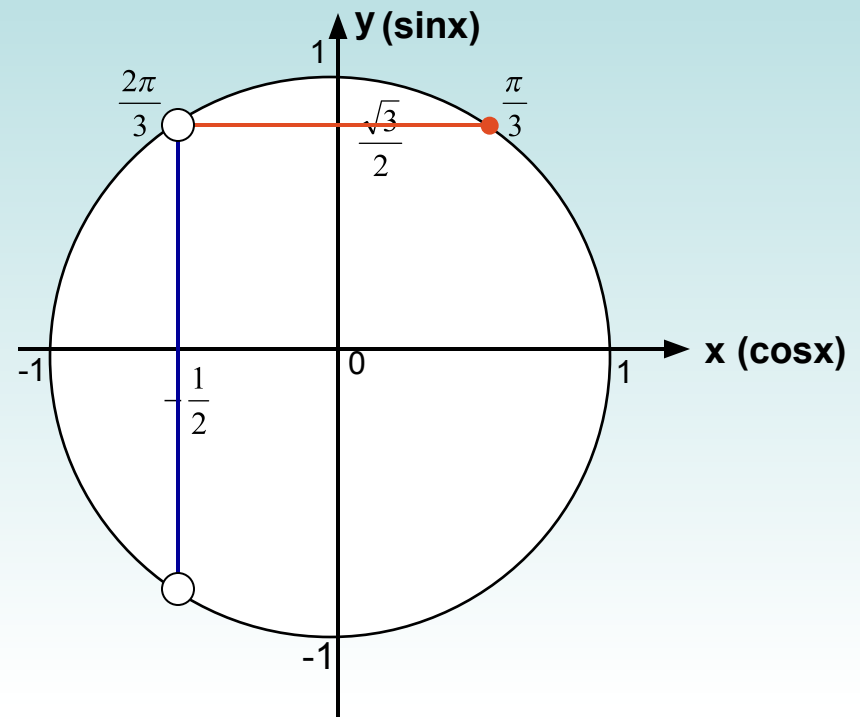

$$x = \frac{\pi}{3} + 2\pi n, \in \mathbb{Z}$$

При каких значениях параметра  $a$  уравнение

$$\sin^2 x - (2a - 1) \cdot \sin x + a^2 - a = 0 \text{ имеет решение?}$$

$$D = (-(2a - 1))^2 - 4 \cdot 1 \cdot (a^2 - a) = 4a^2 - 4a + 1 - 4a^2 + 4a = 1$$

$$\begin{cases} \sin x = a - 1; \\ \sin x = a. \end{cases}$$

$$\begin{cases} -1 \leq a - 1 \leq 1, \\ -1 \leq a \leq 1; \end{cases}$$

$$\begin{cases} 0 \leq a \leq 2, \\ -1 \leq a \leq 1. \end{cases}$$

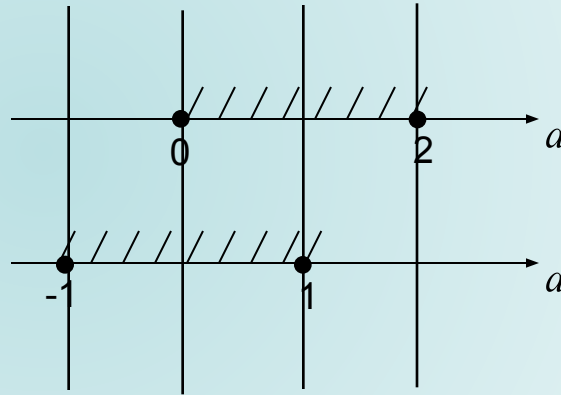

$$a \in [-1; 2]$$

# Самостоятельная работа

ВАРИАНТ 1

ВАРИАНТ 2

Решите уравнения

$$\cos x = 0$$

$$\sin x = -\frac{1}{2}$$

$$\operatorname{ctgx} = \sqrt{3}$$

$$\operatorname{tgx} \cdot \cos x = 1$$

$$\sin x = 1$$

$$\cos x = -\frac{\sqrt{2}}{2}$$

$$\operatorname{tgx} = \frac{\sqrt{3}}{3}$$

$$\operatorname{ctgx} \cdot \sin x = 1$$

ДОПОЛНИТЕЛЬНОЕ ЗАДАНИЕ

$$\frac{\sin x}{\sqrt{\pi - x^2}} = 0$$

$$\cos x \cdot (\sin x + \sqrt{2}) = 0$$
$$x \in [1; 3]$$

# Проверяем решения

## ВАРИАНТ 1

1.

$$\cos x = 0$$

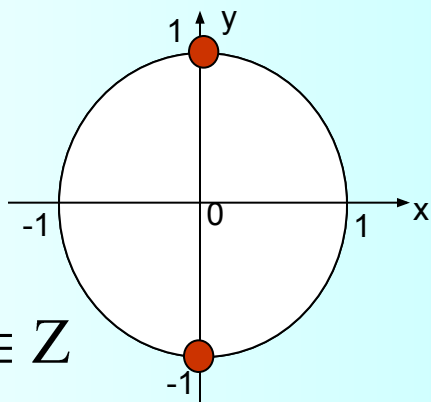

$$x = \frac{\pi}{2} + \pi n, n \in \mathbb{Z}$$

2.

$$\sin x = \frac{1}{2}$$

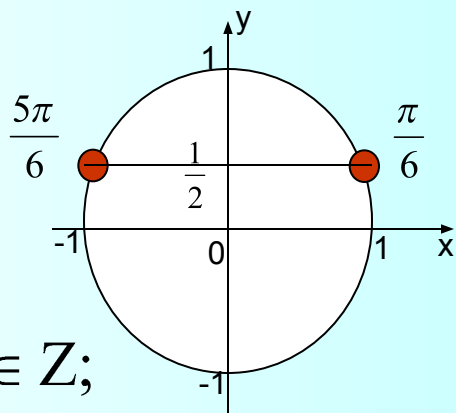

$$\left[ \begin{array}{l} x = \frac{\pi}{6} + 2\pi n, n \in \mathbb{Z}; \\ x = \frac{5\pi}{6} + 2\pi n, n \in \mathbb{Z}. \end{array} \right.$$

## ВАРИАНТ 2

1.

$$\sin x = 1$$

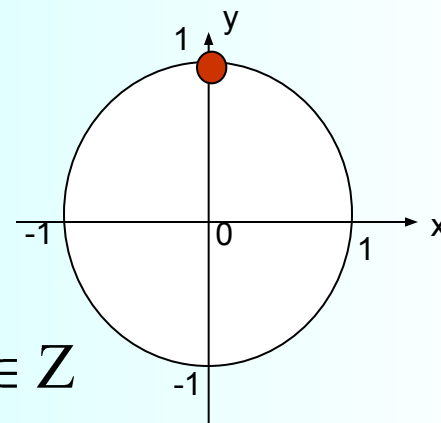

$$x = \frac{\pi}{2} + 2\pi n, n \in \mathbb{Z}$$

2.

$$\cos x = -\frac{\sqrt{2}}{2}$$

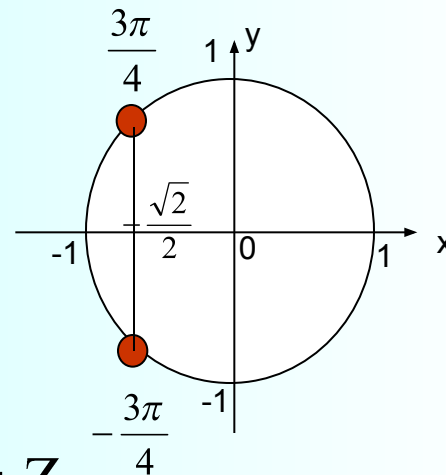

$$x = \pm \frac{3\pi}{4} + 2\pi n, n \in \mathbb{Z}$$

# ВАРИАНТ 1

3.

$$\operatorname{ctgx} = \sqrt{3}$$

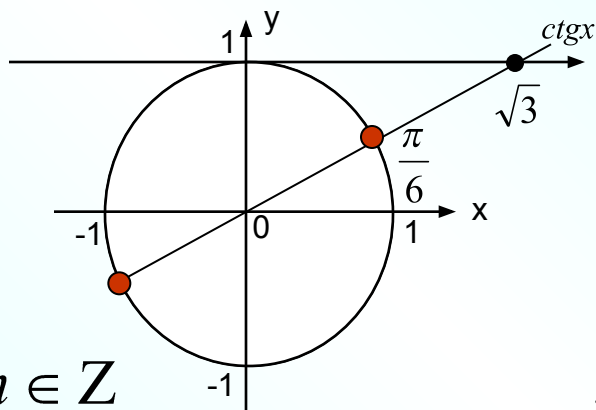

$$x = \frac{\pi}{6} + \pi n, n \in \mathbb{Z}$$

4.

$$\operatorname{tgx} \cdot \cos x = 1$$

$$\begin{cases} \cos x \neq 0; \\ \sin x = 1. \end{cases}$$

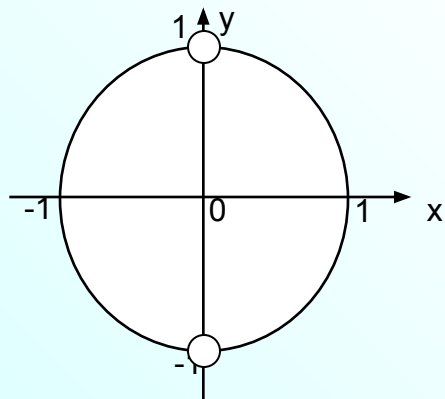

Нет решений

# ВАРИАНТ 2

3.

$$\operatorname{tgx} = \frac{\sqrt{3}}{3}$$

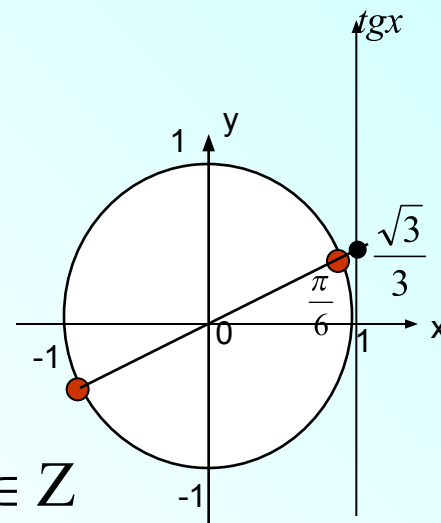

$$x = \frac{\pi}{6} + \pi n, n \in \mathbb{Z}$$

4.

$$\operatorname{ctgx} \cdot \sin x = 1$$

$$\begin{cases} \sin x \neq 0; \\ \cos x = 1. \end{cases}$$

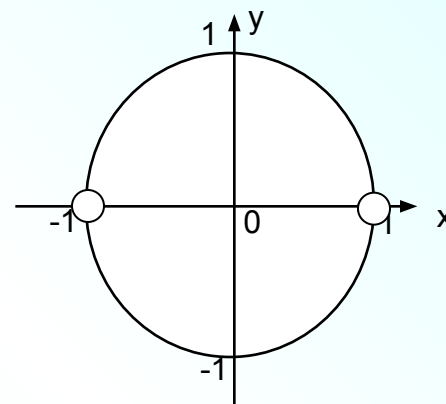

Нет решений

## *Домашняя работа*

1. Дополнительные задания из самостоятельной работы.
2. № 13.28, 13.29
3. При каких значениях параметра уравнение  $\sin x = \frac{a^2}{a-2}$  имеет решения?
4. Найти наибольший отрицательный корень уравнения  $\cos^2 x - 2 \sin x + 2 = 0$ .

Спасибо за урок!