

Авторський пілотний проект



# Частина 1. Клітинна біохімія

Лекція 2. Метаболізм ліпідів.

Метаболізм білків. Стероїди

**Б І Л К И**

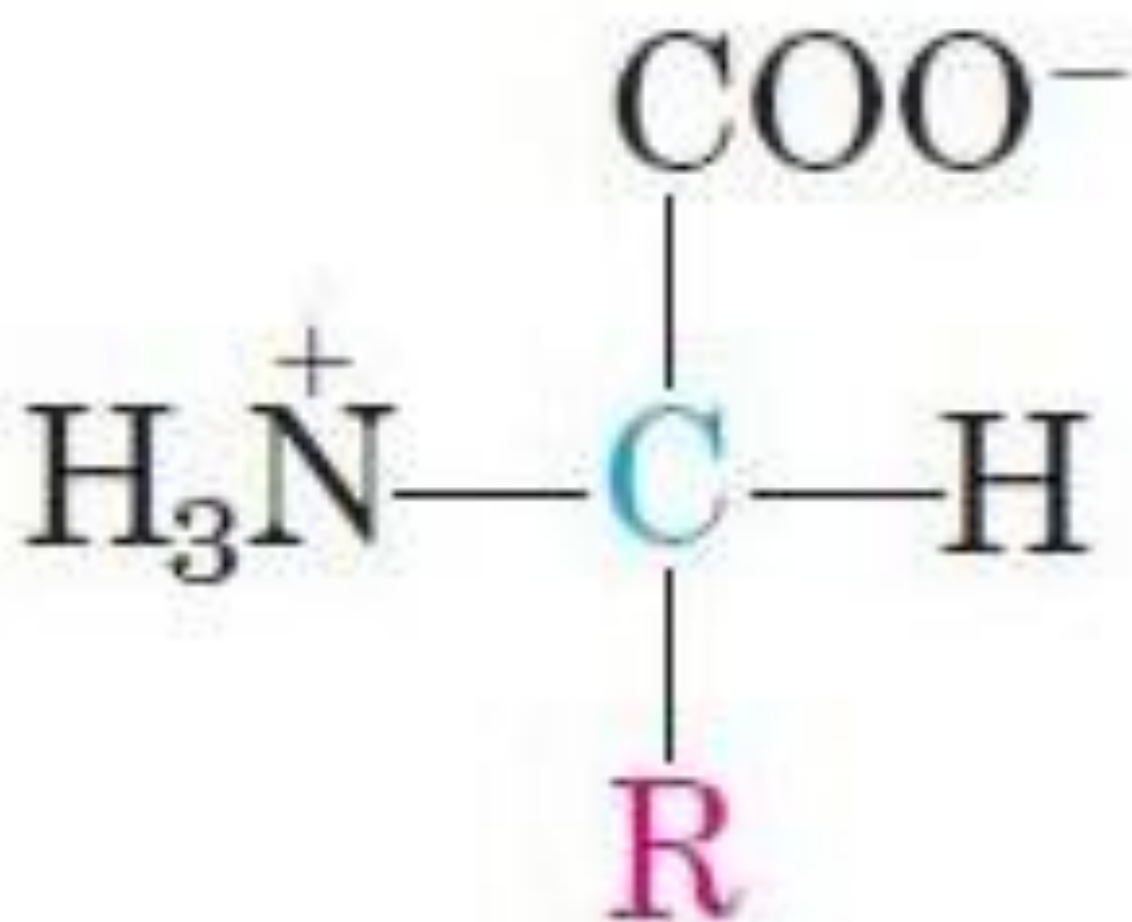

**Nonpolar, aliphatic R groups**

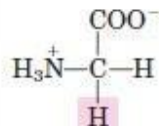

Glycine

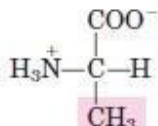

Alanine

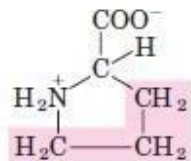

Proline

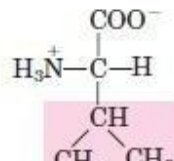

Valine

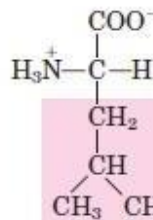

Leucine

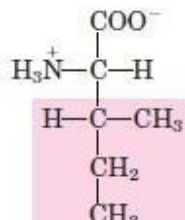

Isoleucine

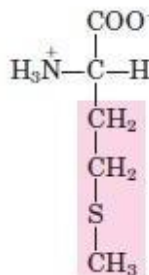

Methionine

**Polar, uncharged R groups**

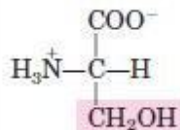

Serine

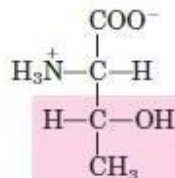

Threonine

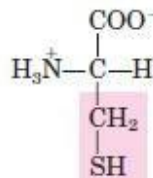

Cysteine

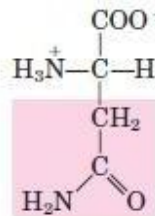

Asparagine

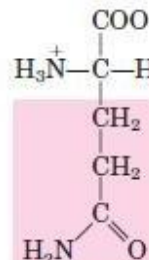

Glutamine

**Aromatic R groups**

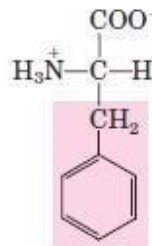

Phenylalanine

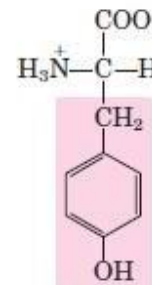

Tyrosine

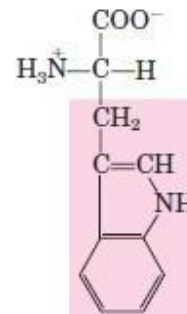

Tryptophan

**Positively charged R groups**

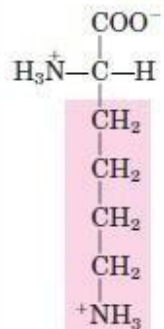

Lysine

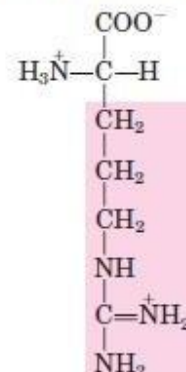

Arginine

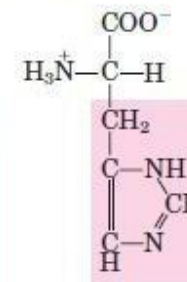

Histidine

**Negatively charged R groups**

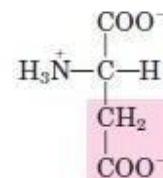

Aspartate

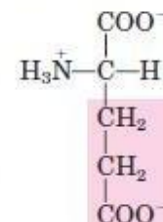

Glutamate

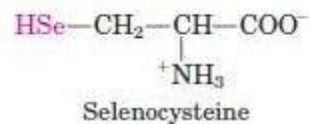
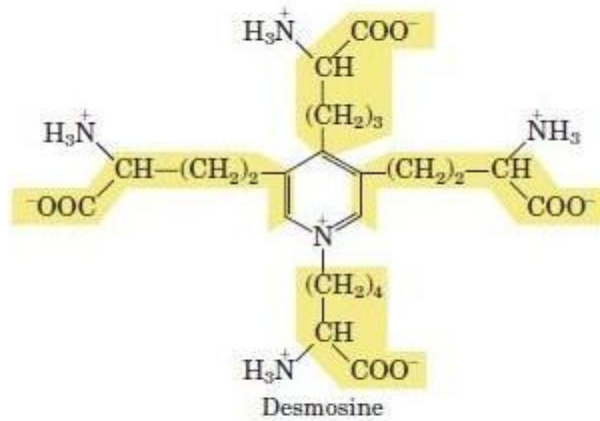
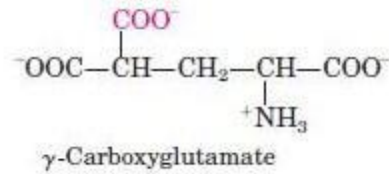
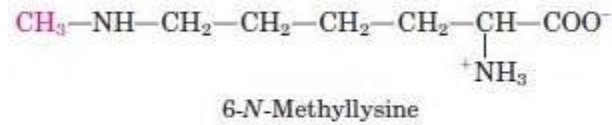
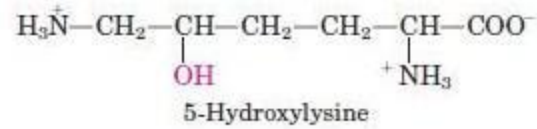
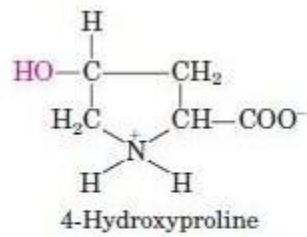

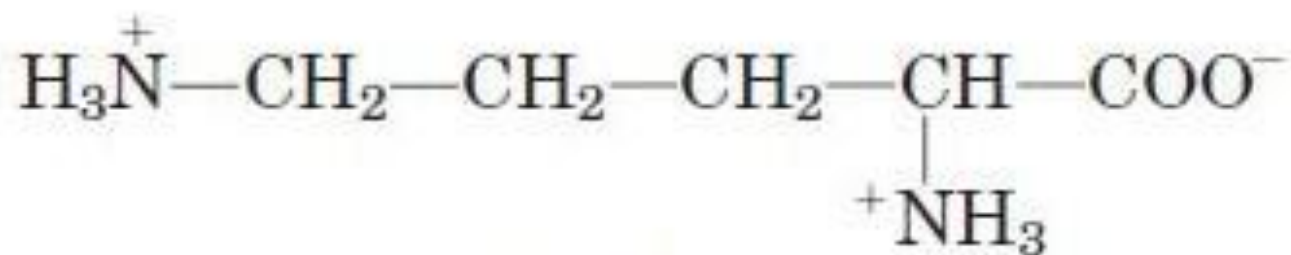

Ornithine

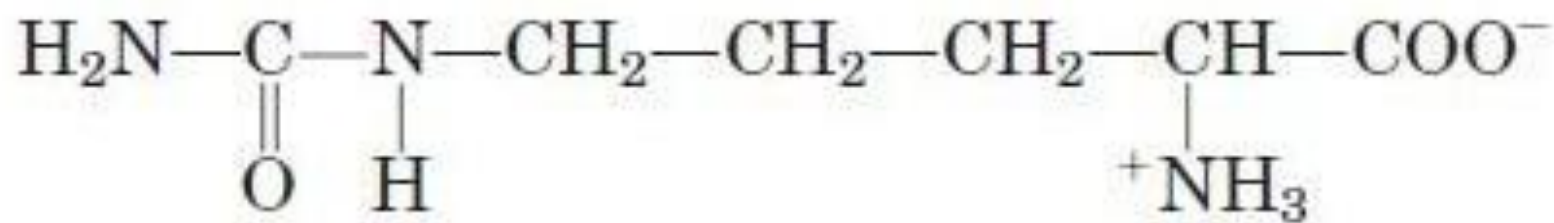

Citrulline

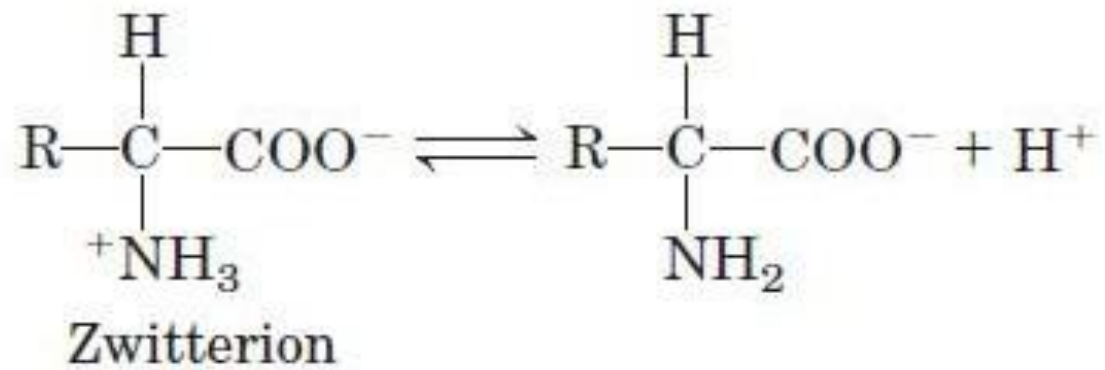

or a base (proton acceptor):

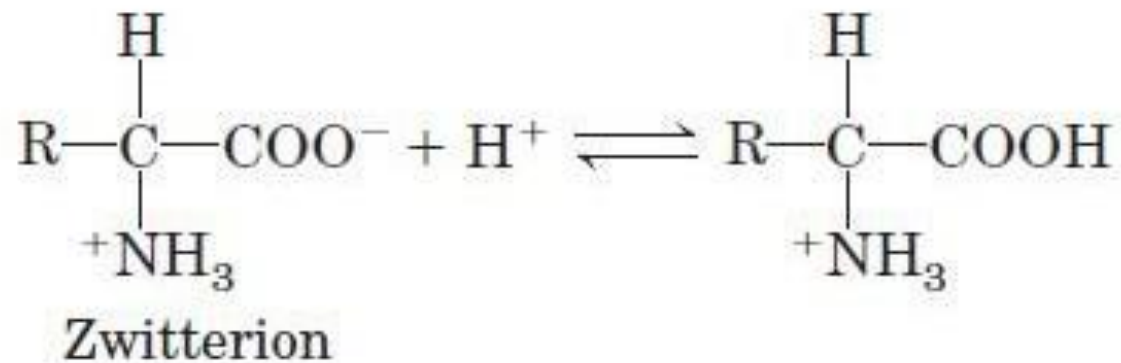

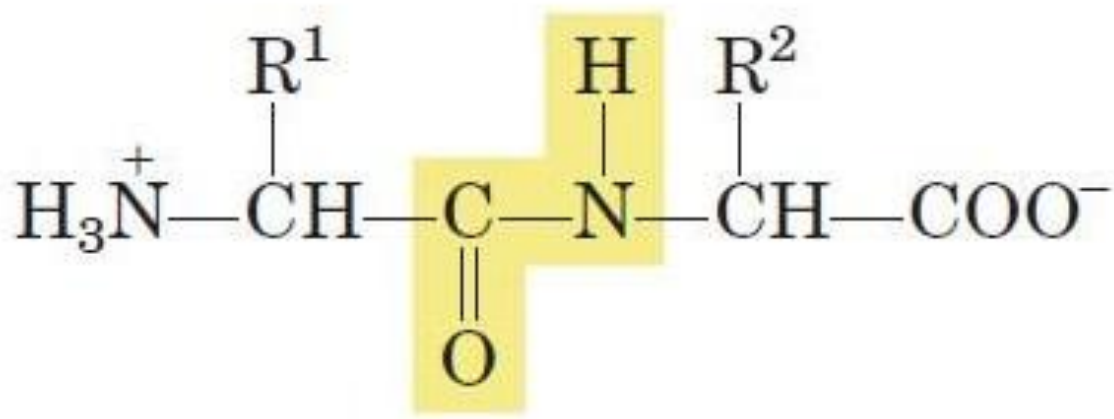
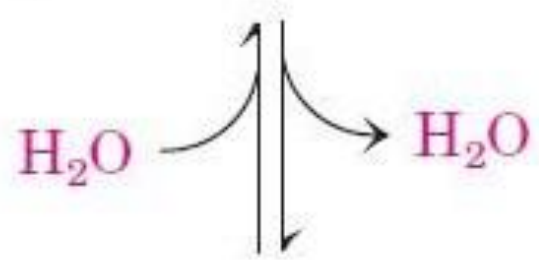
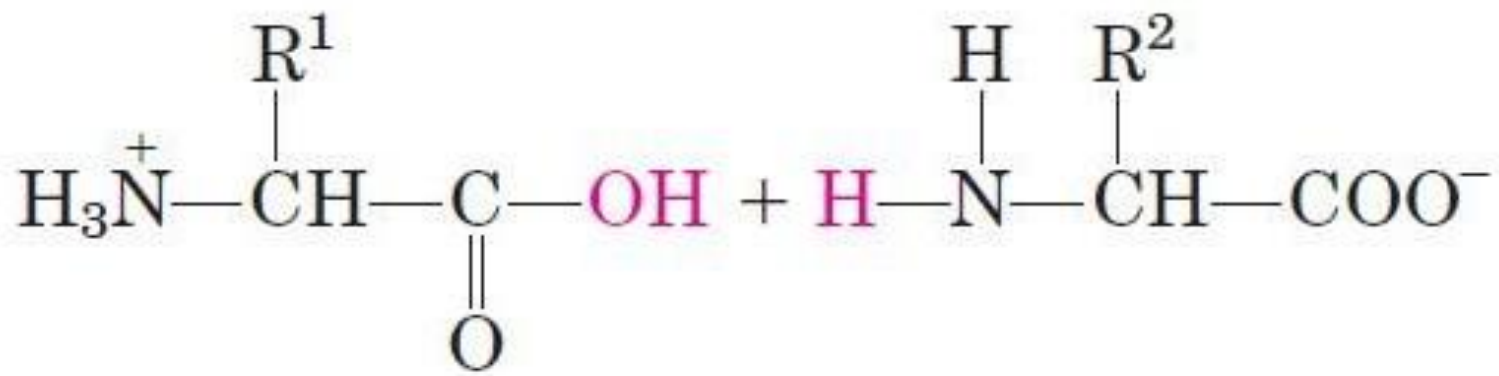



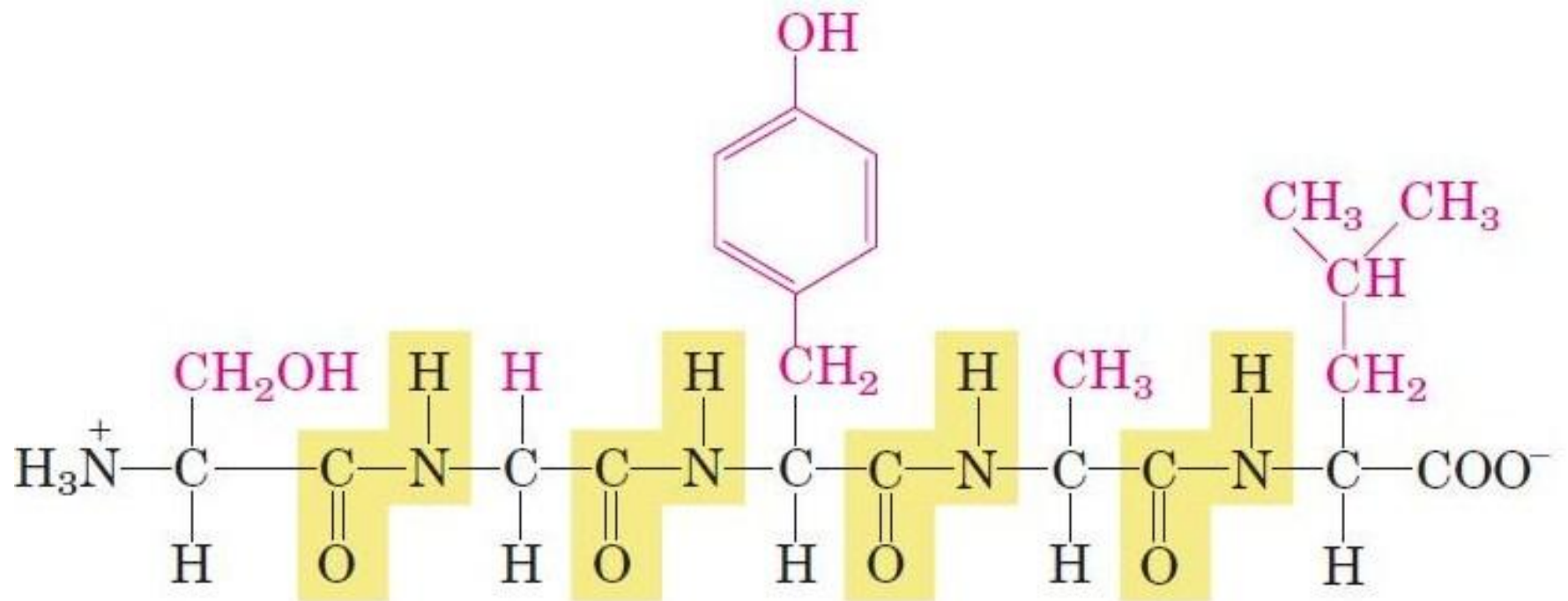

Amino-terminal end

Carboxyl-terminal end

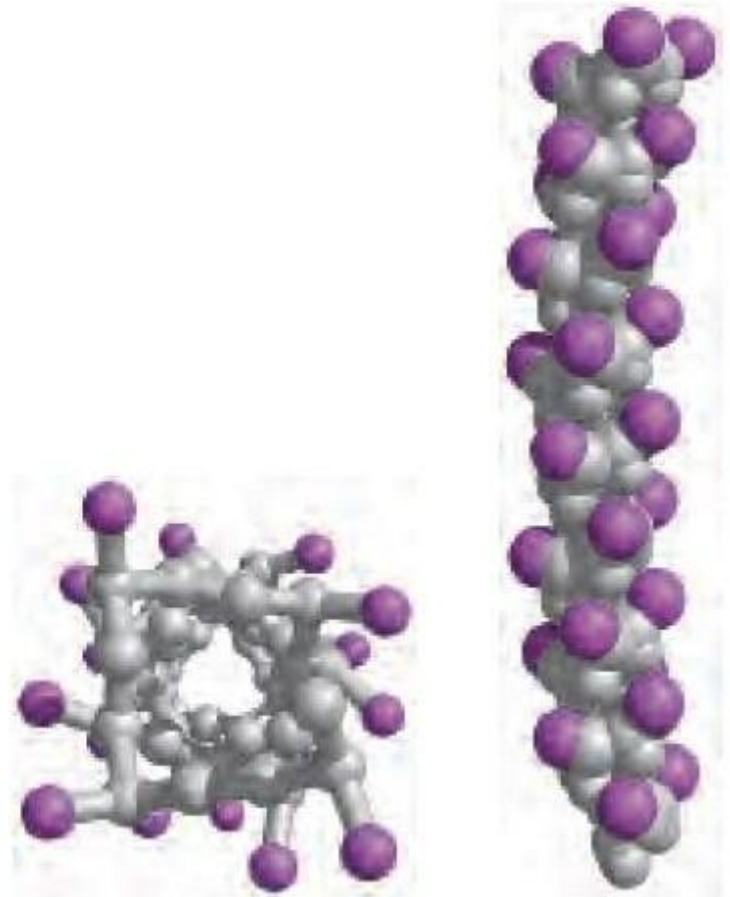
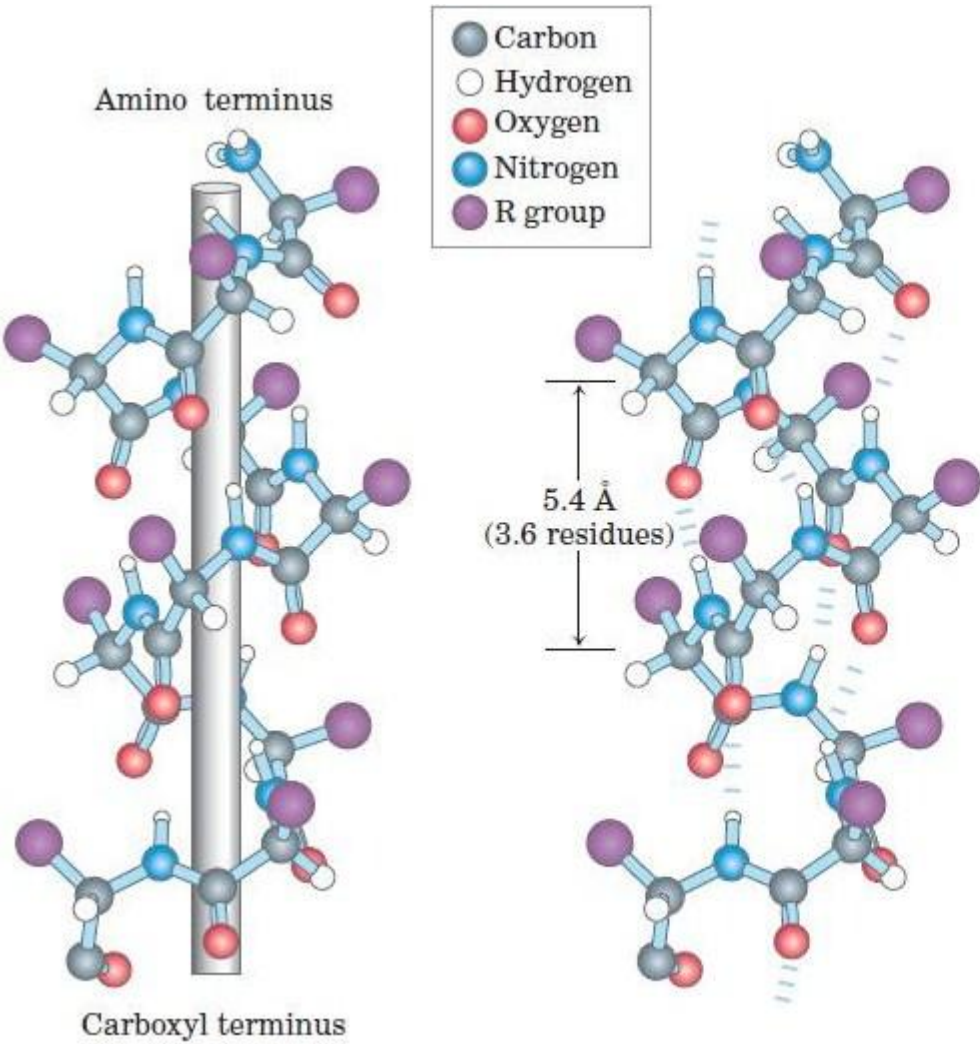

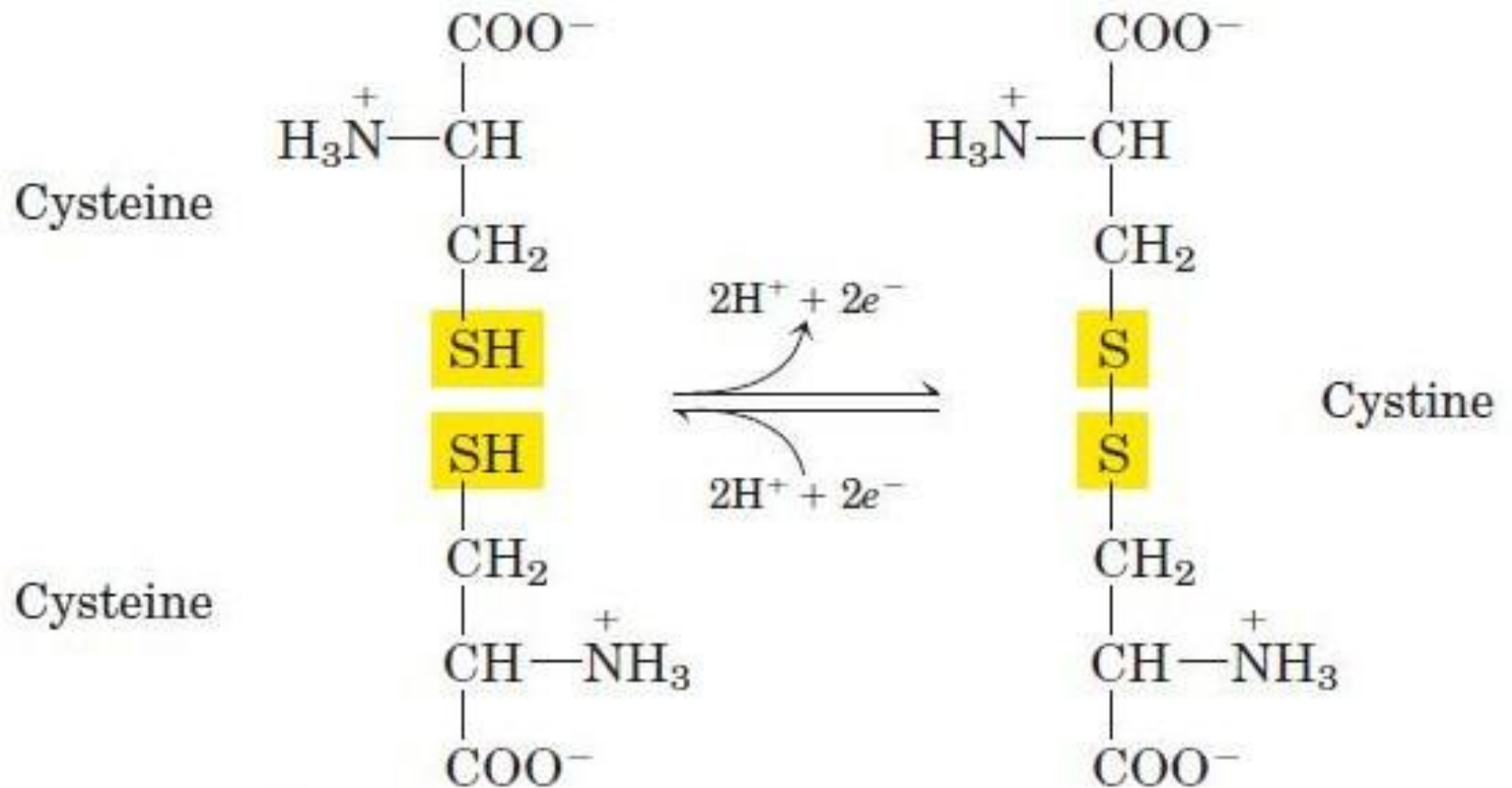

**(a) Antiparallel**

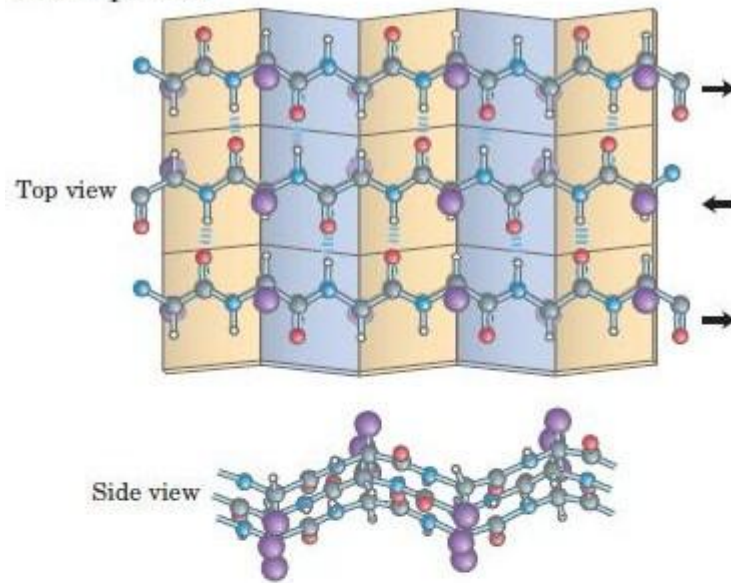

**(b) Parallel**

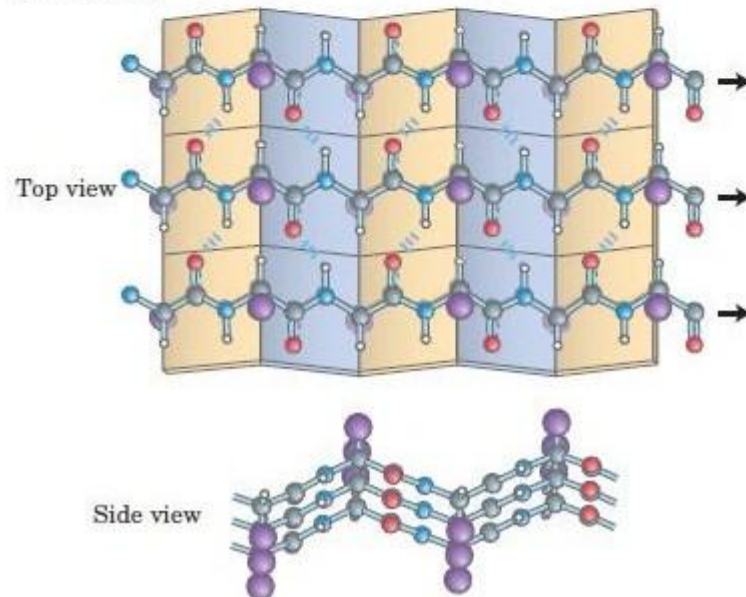

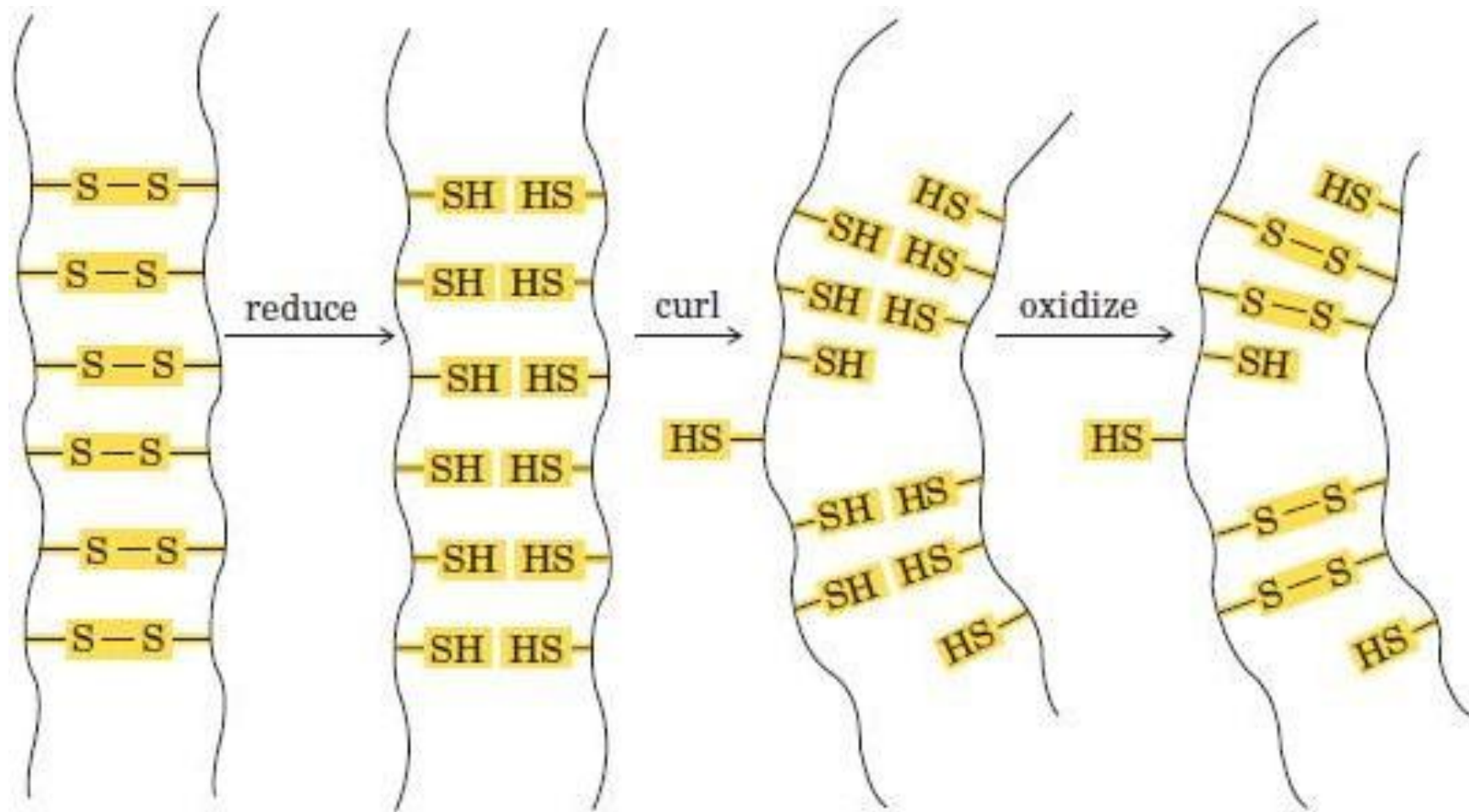

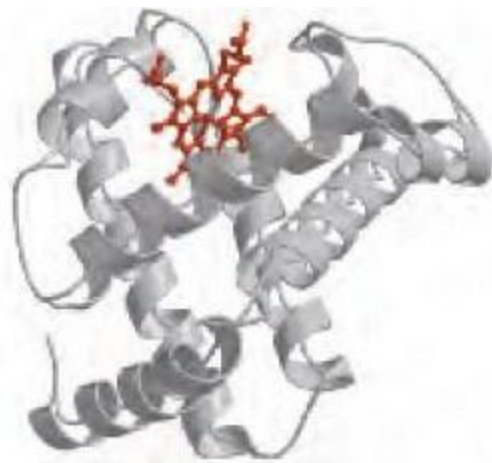

(a)



(b)

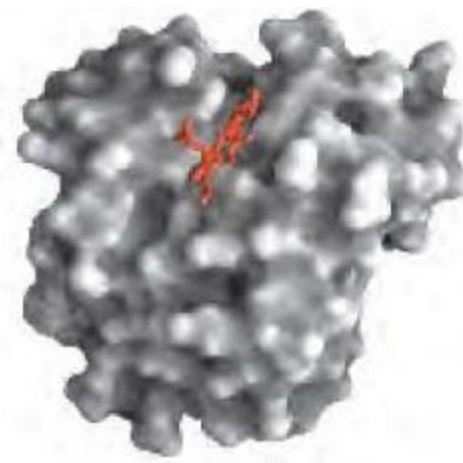

(c)

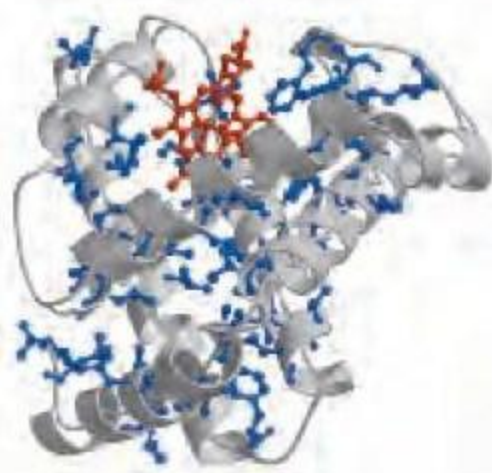

(d)

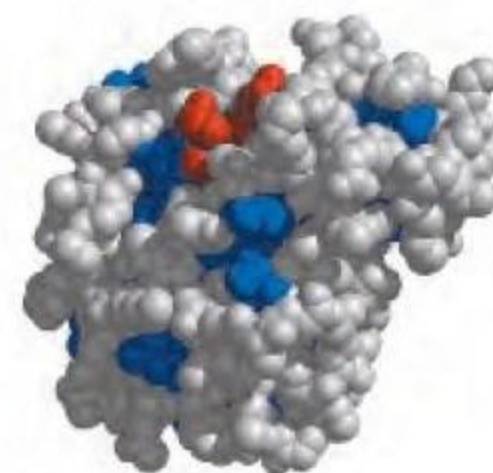

(e)

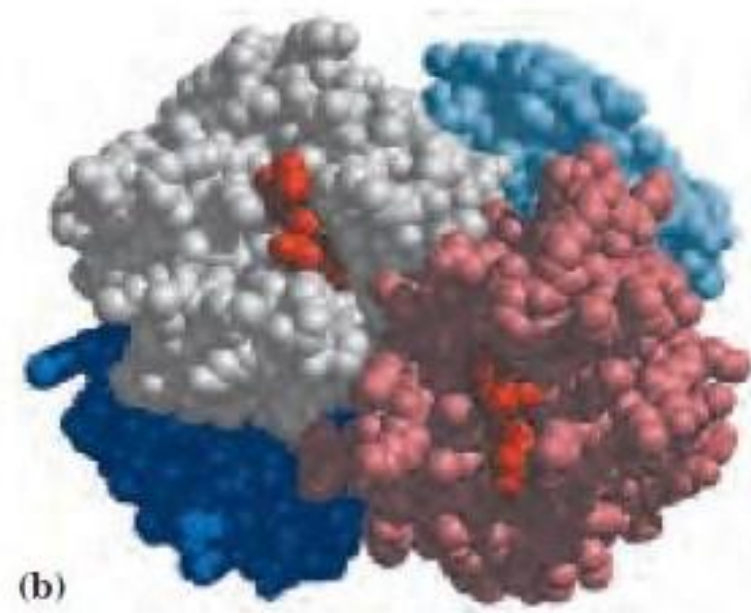
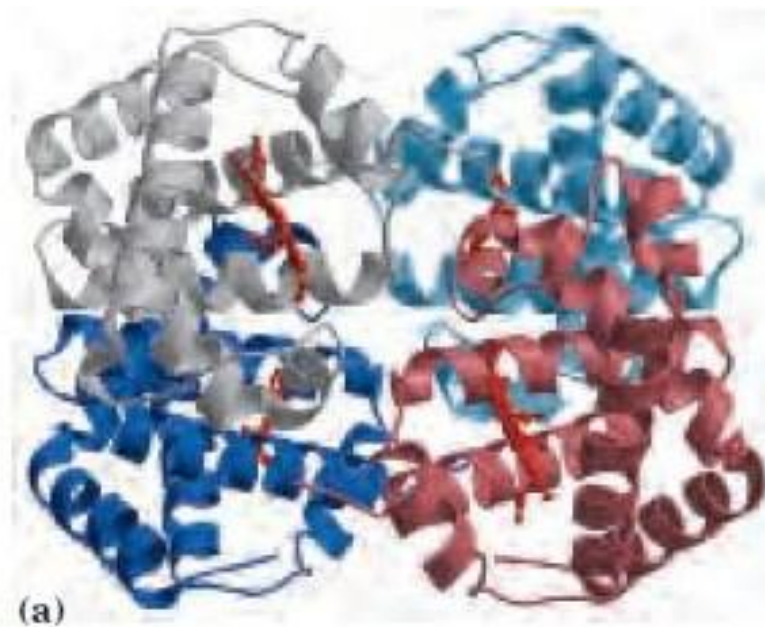





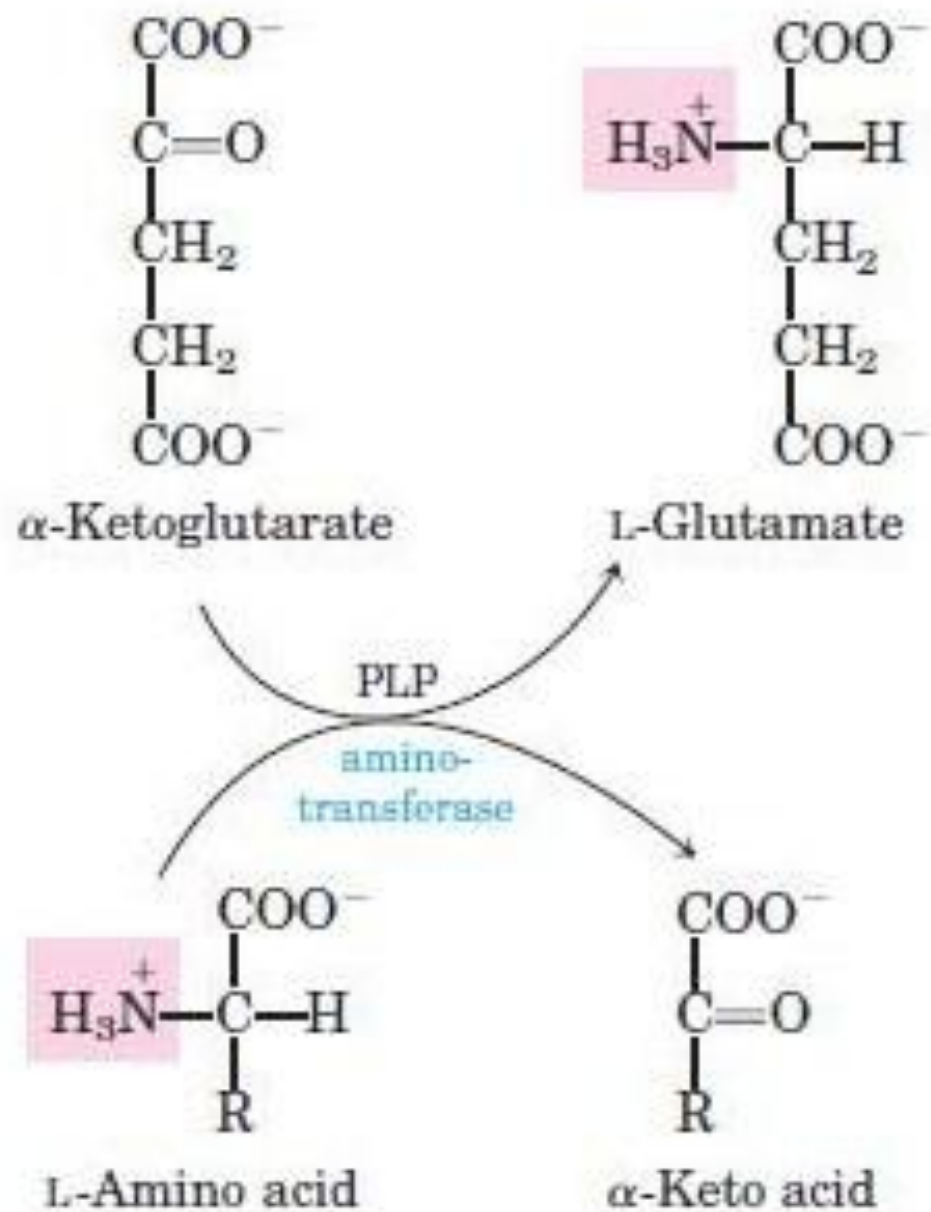

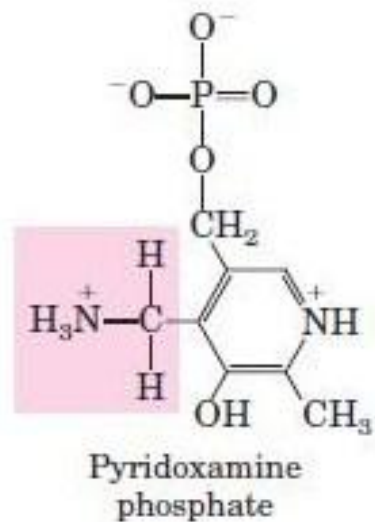
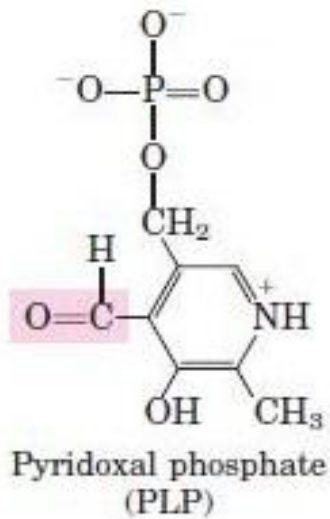

(a)

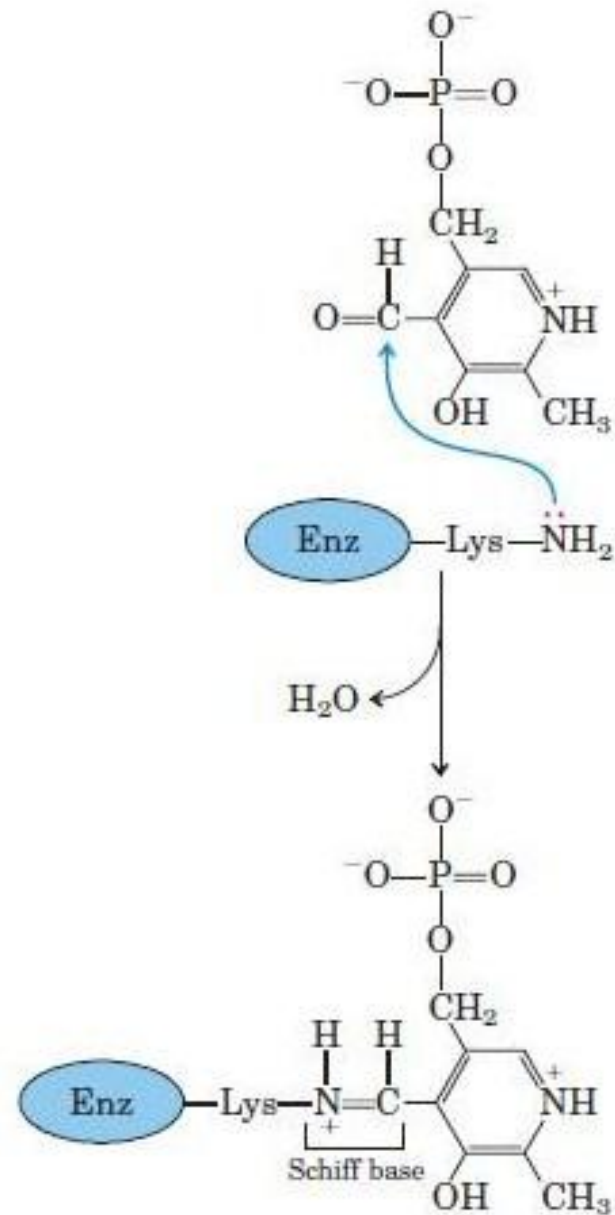

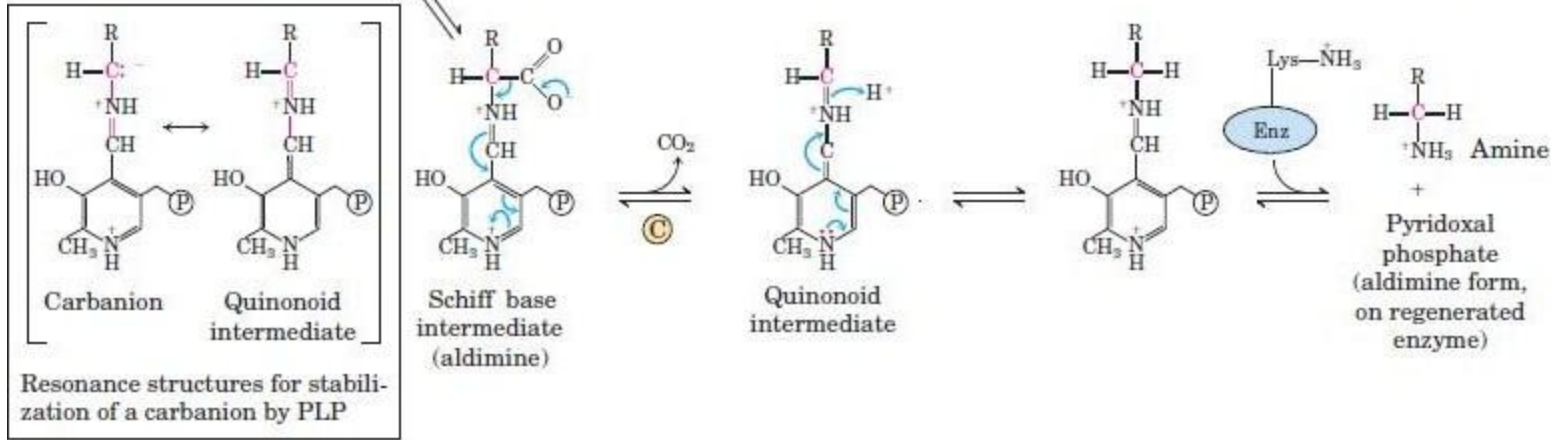
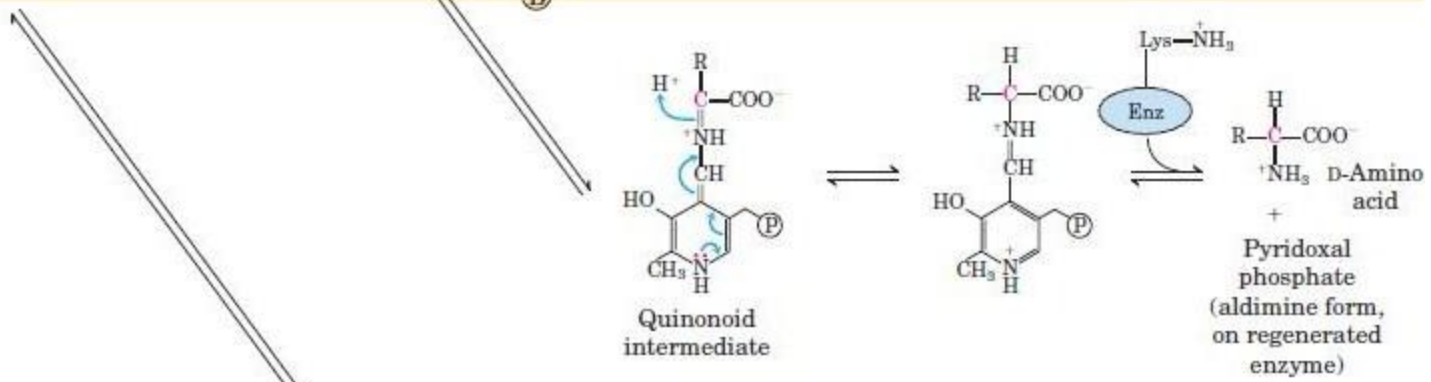
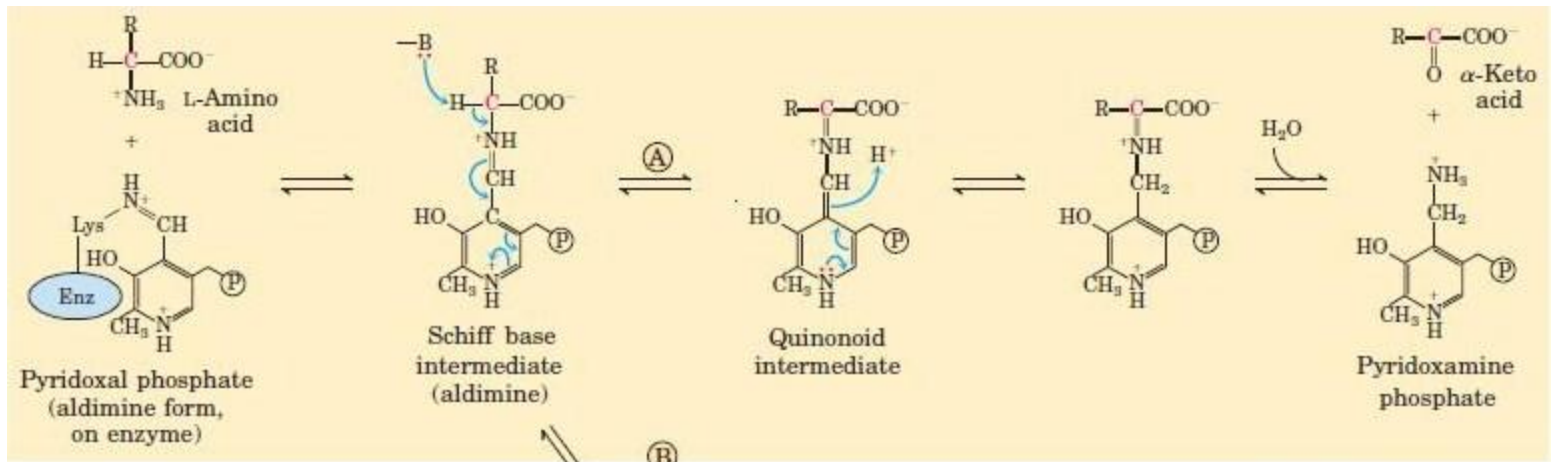

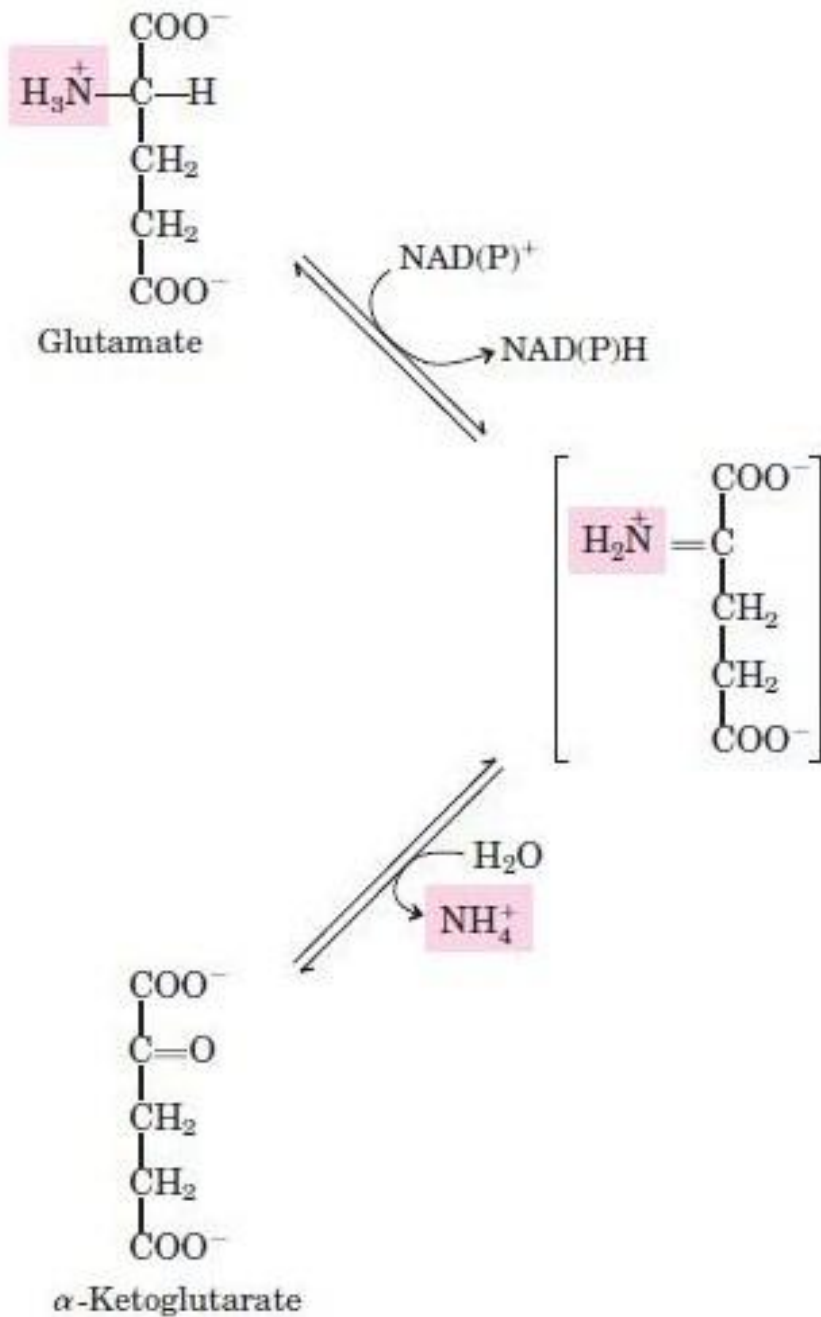

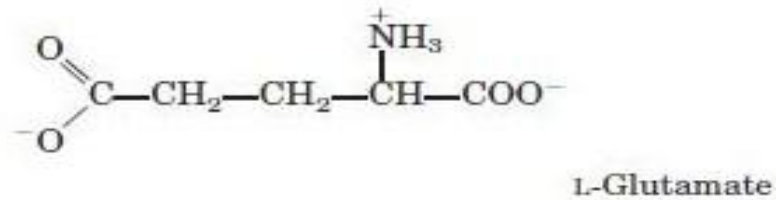
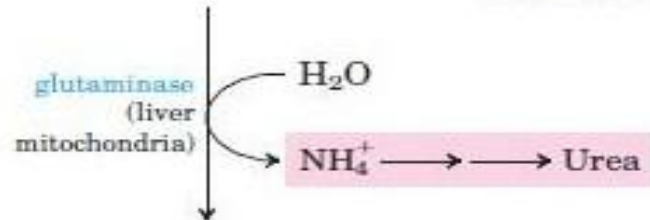
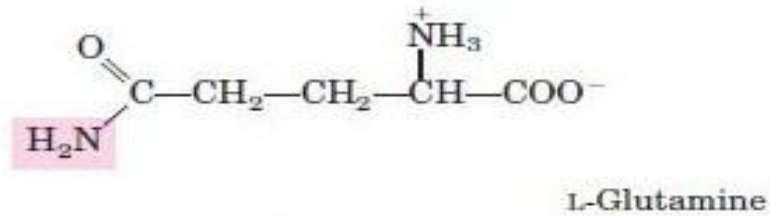
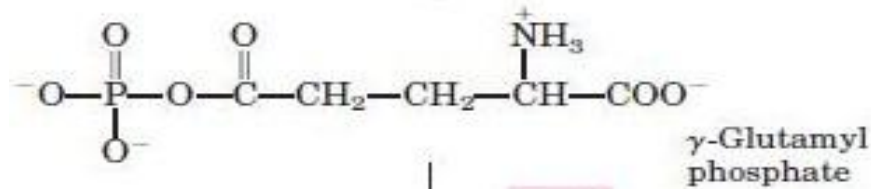
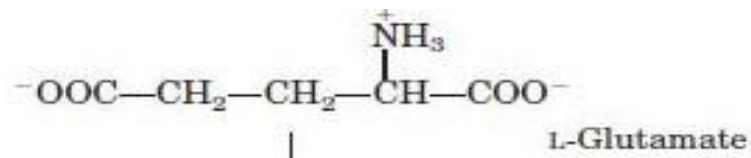

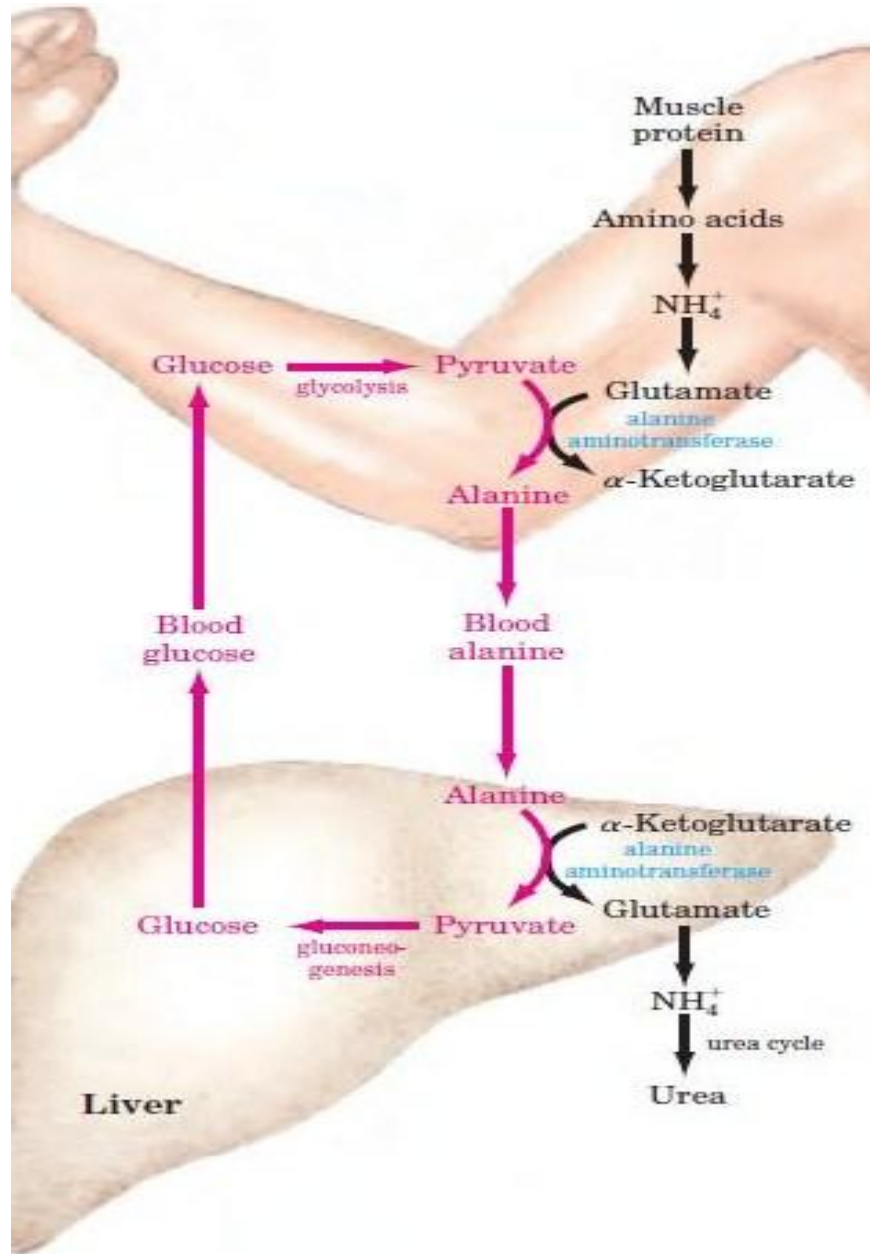

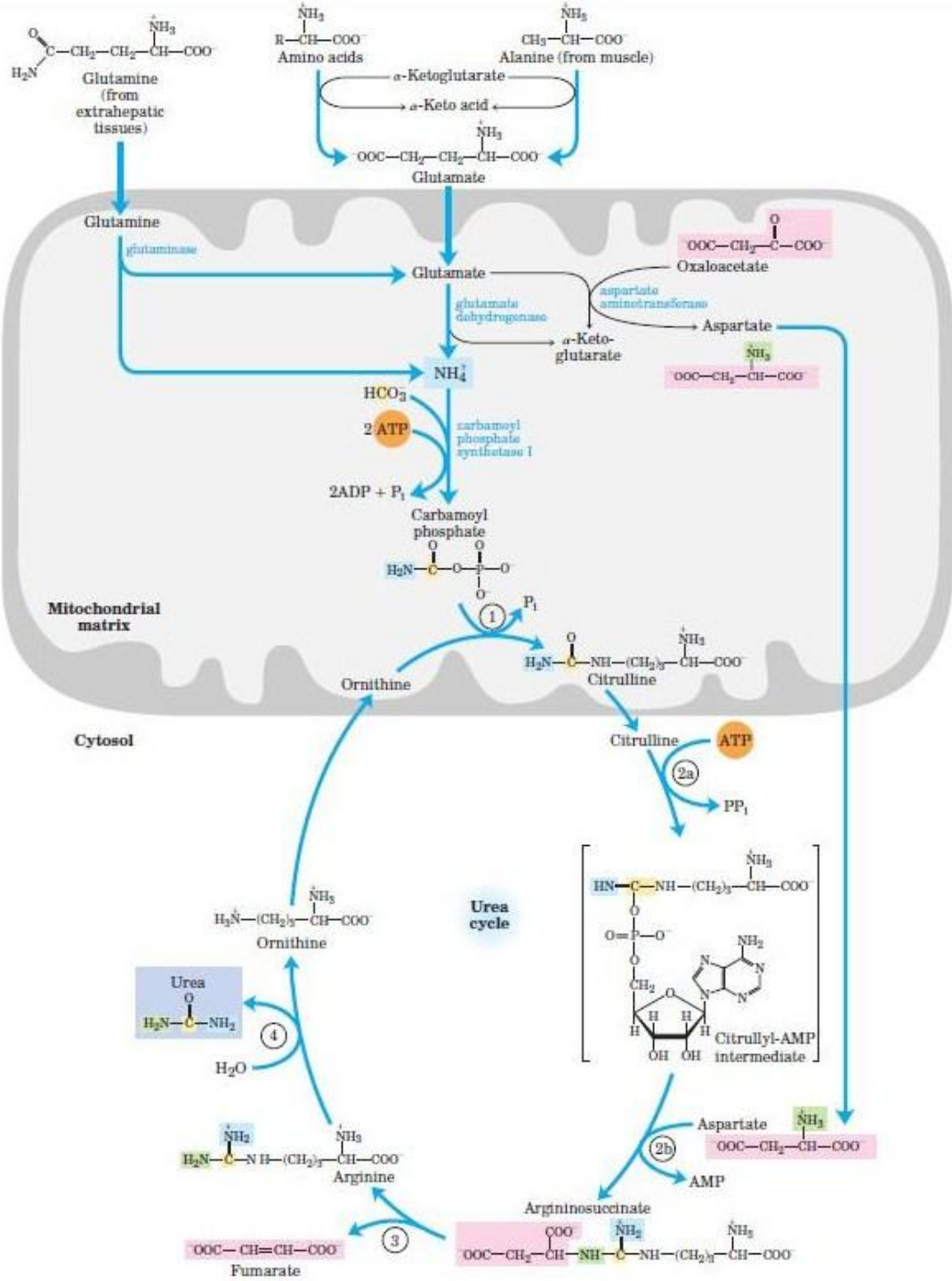

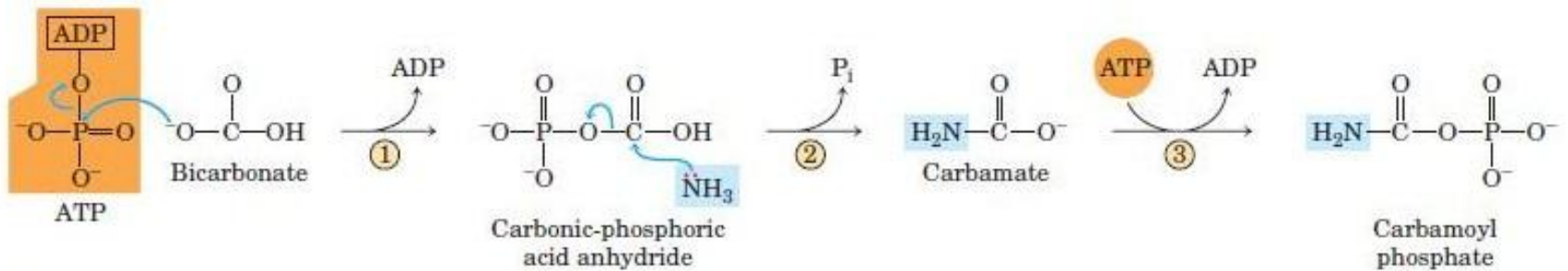

(a)

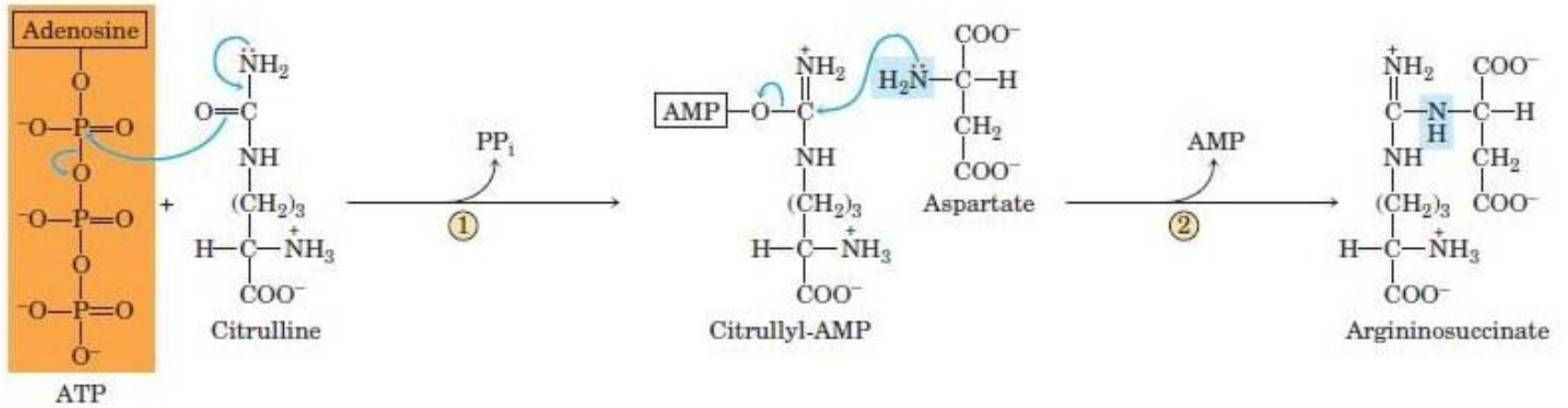

(b)



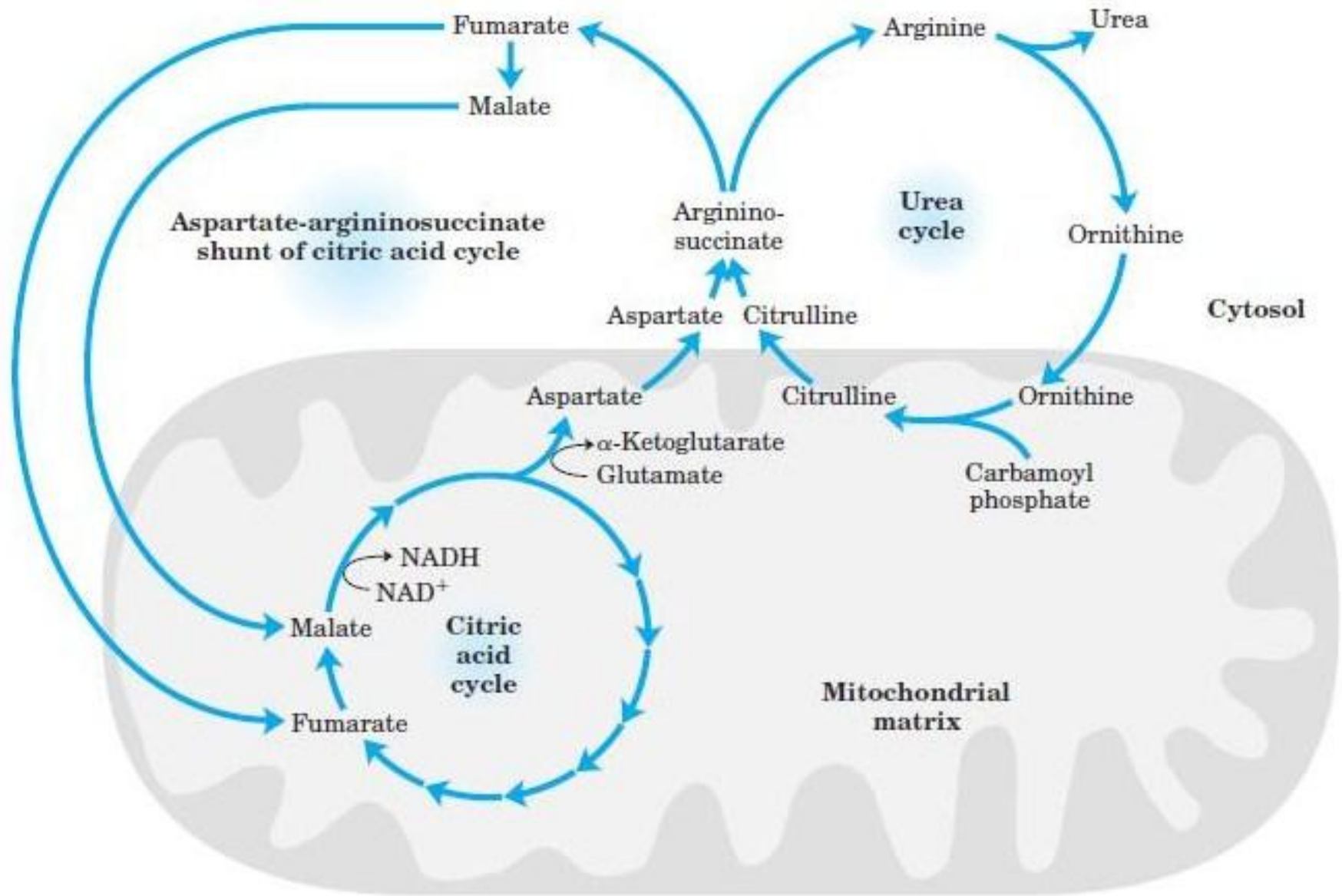

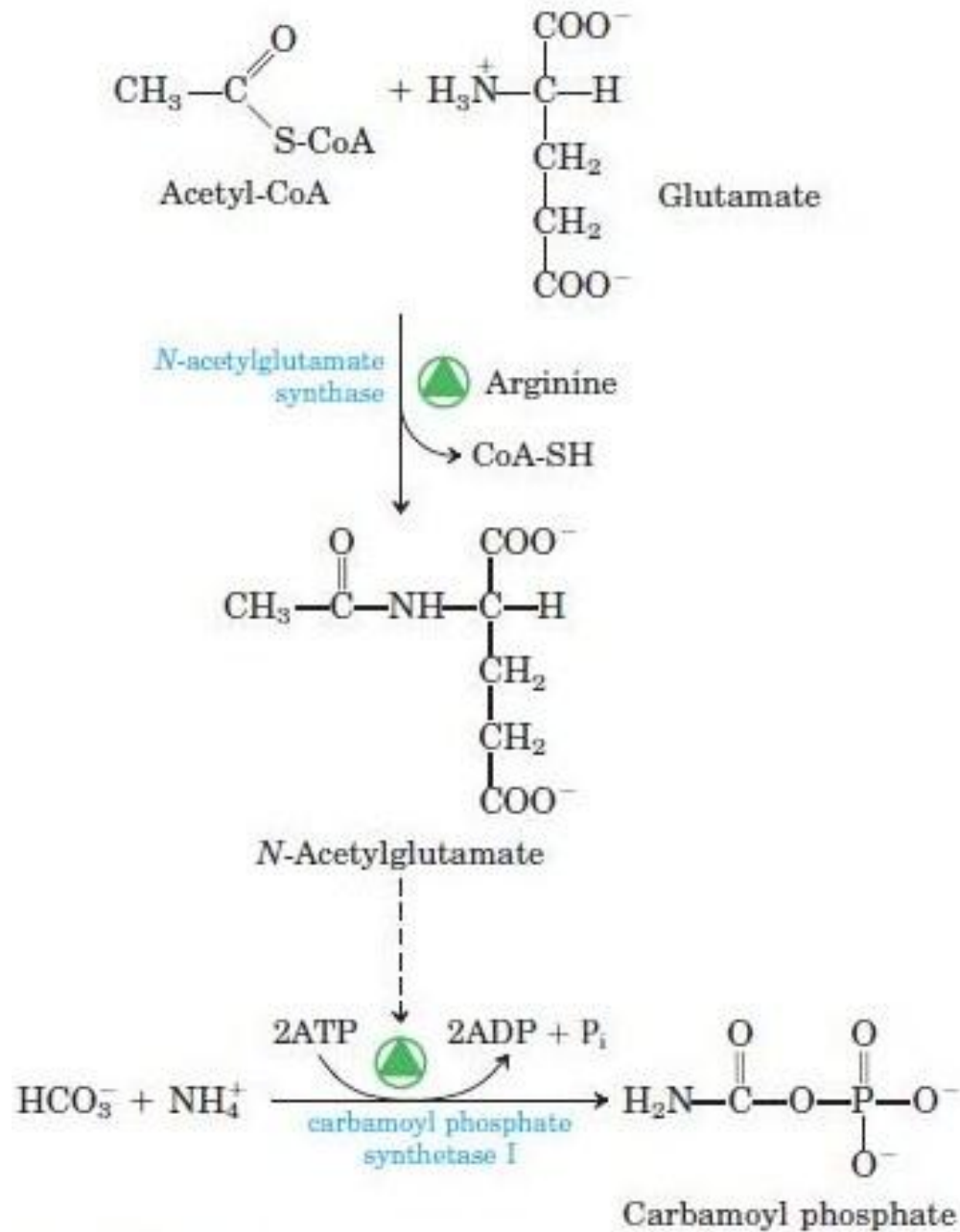

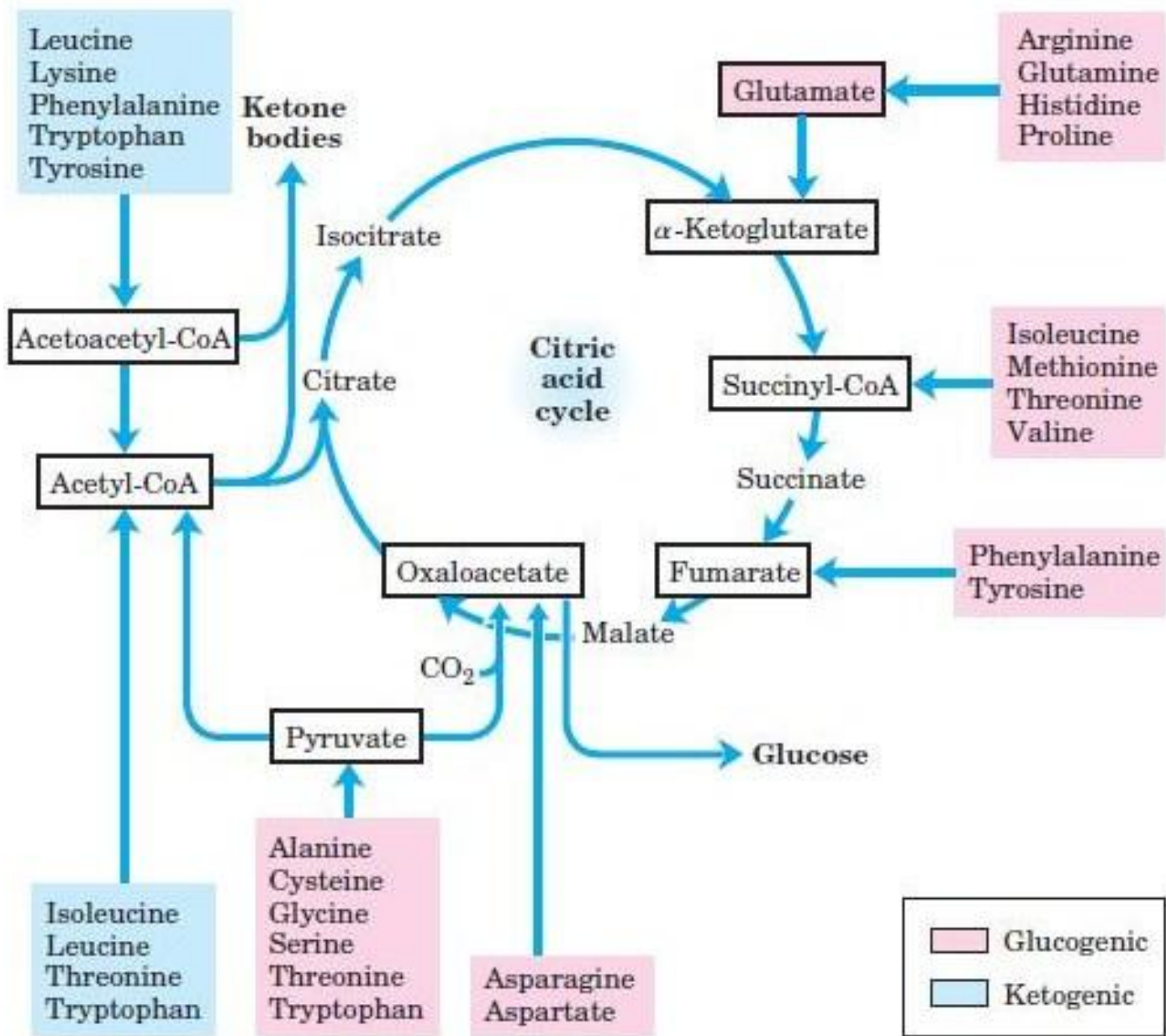

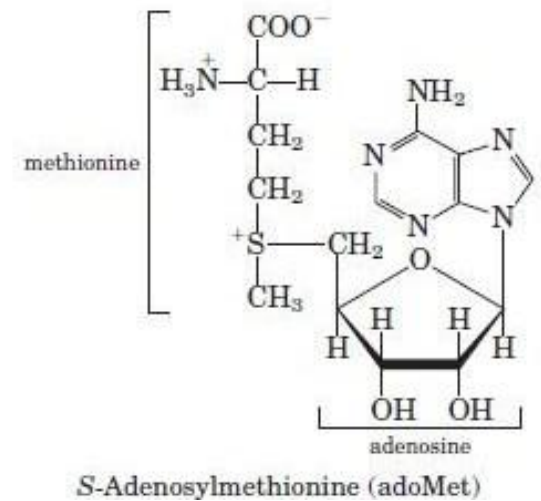
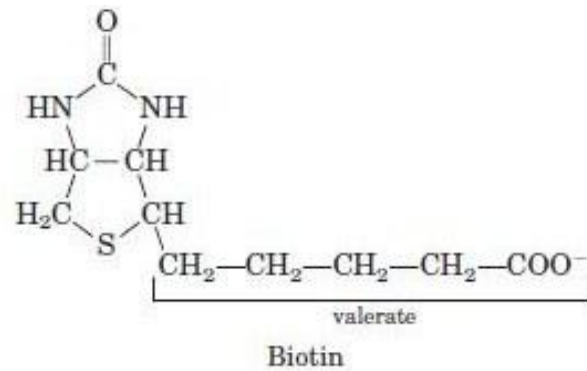
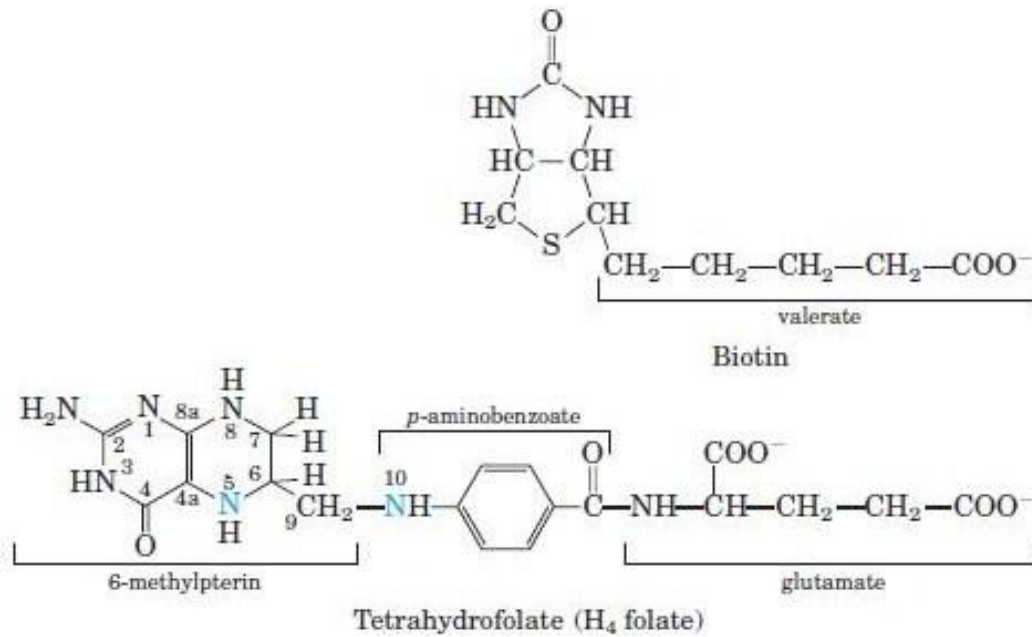

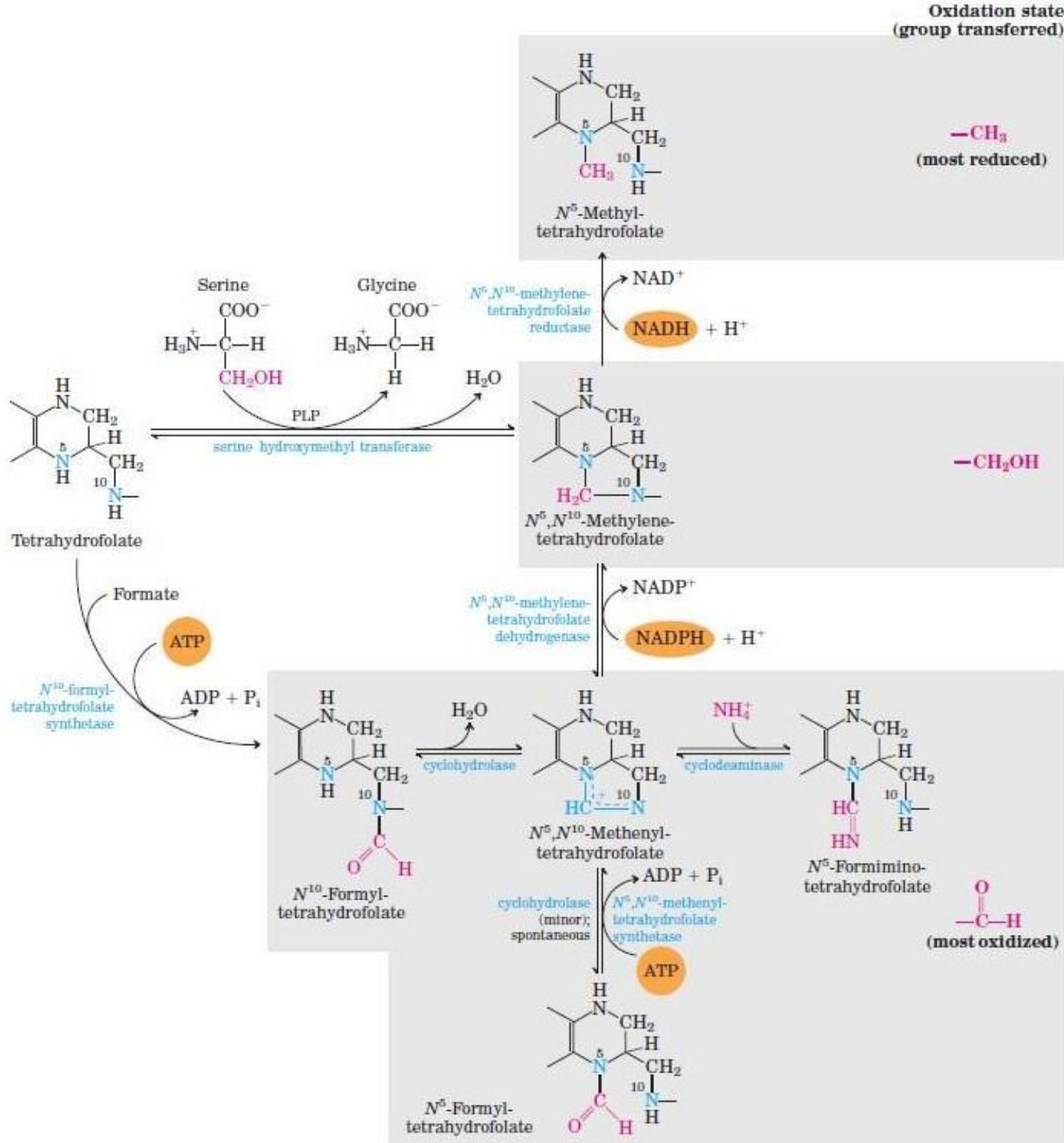

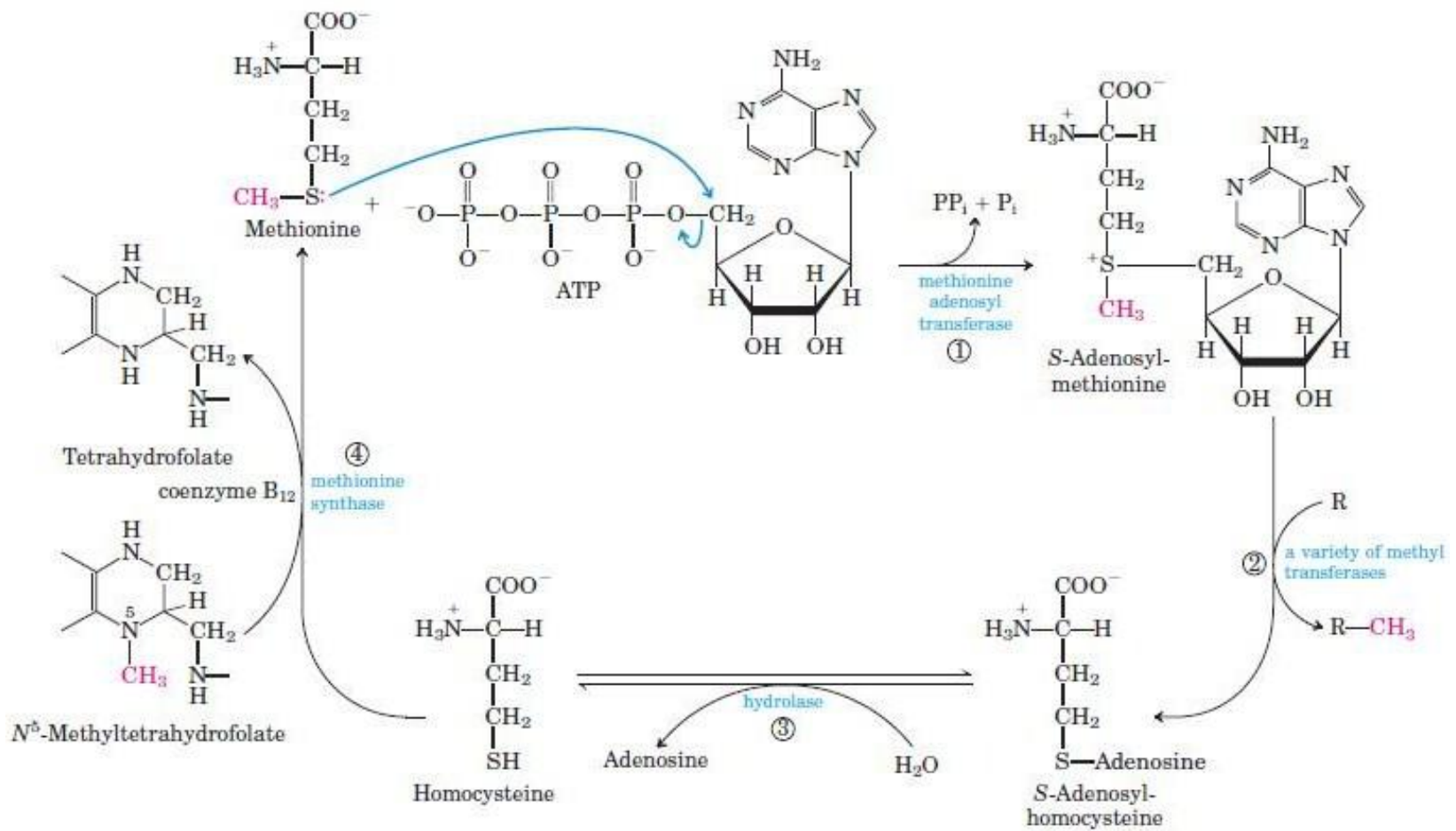

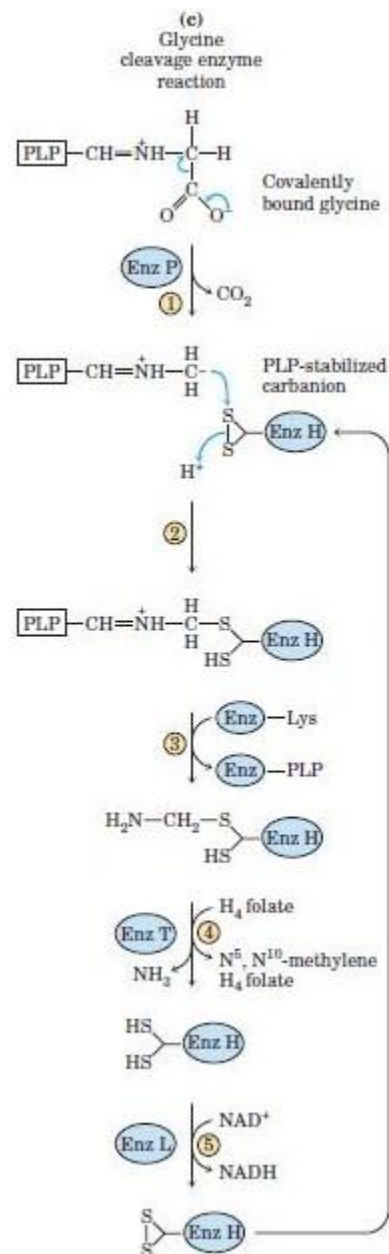
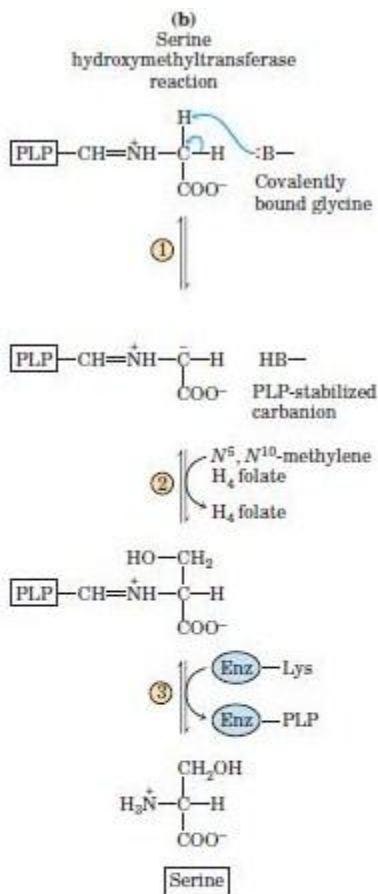
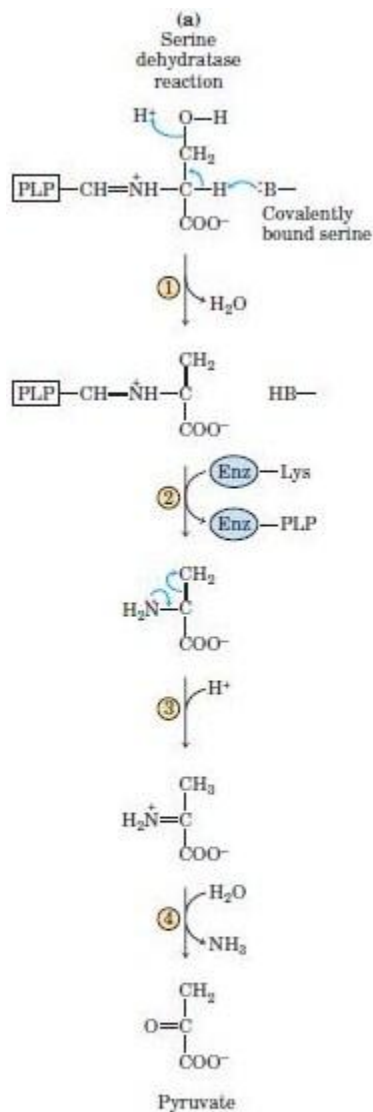

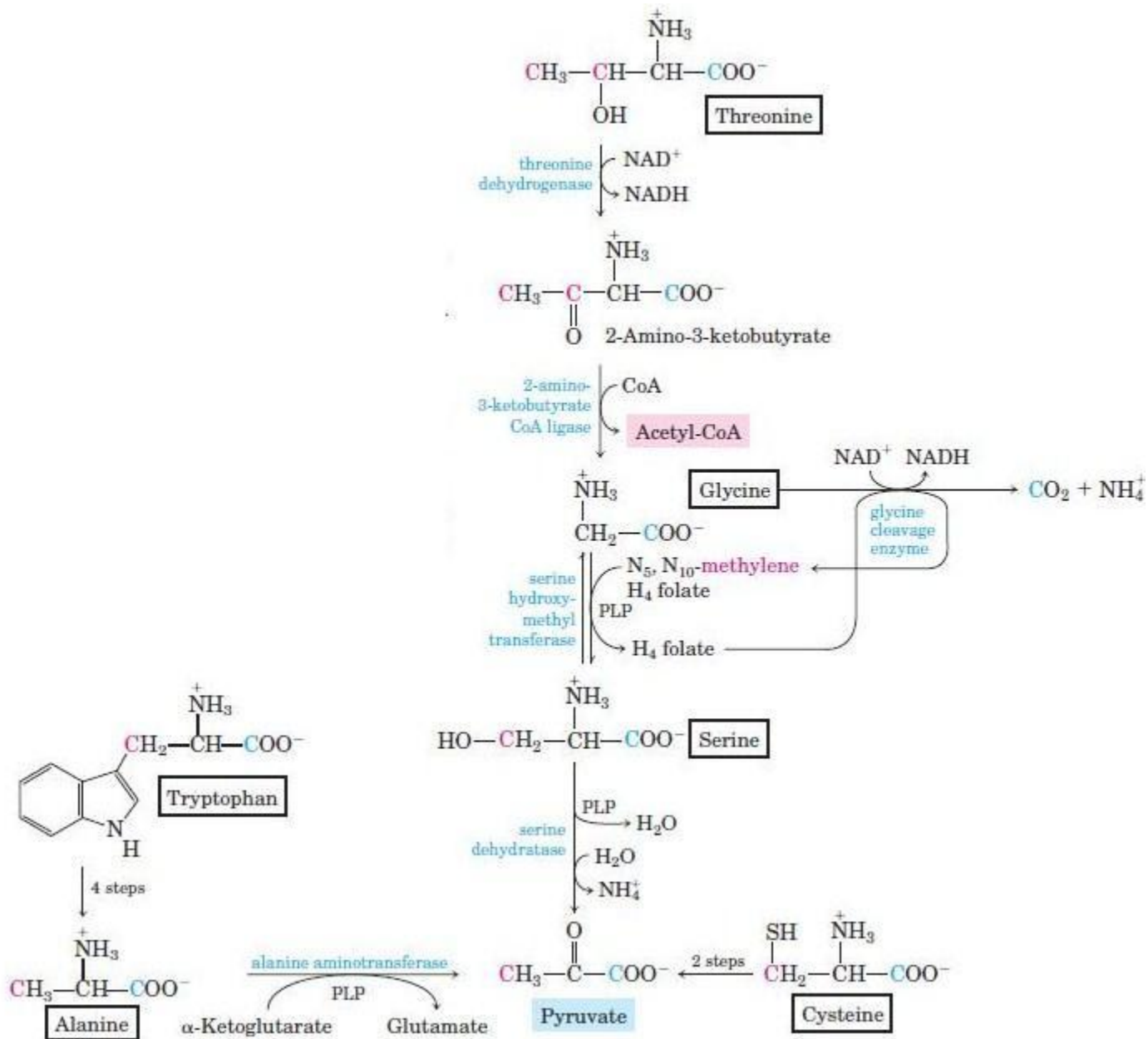



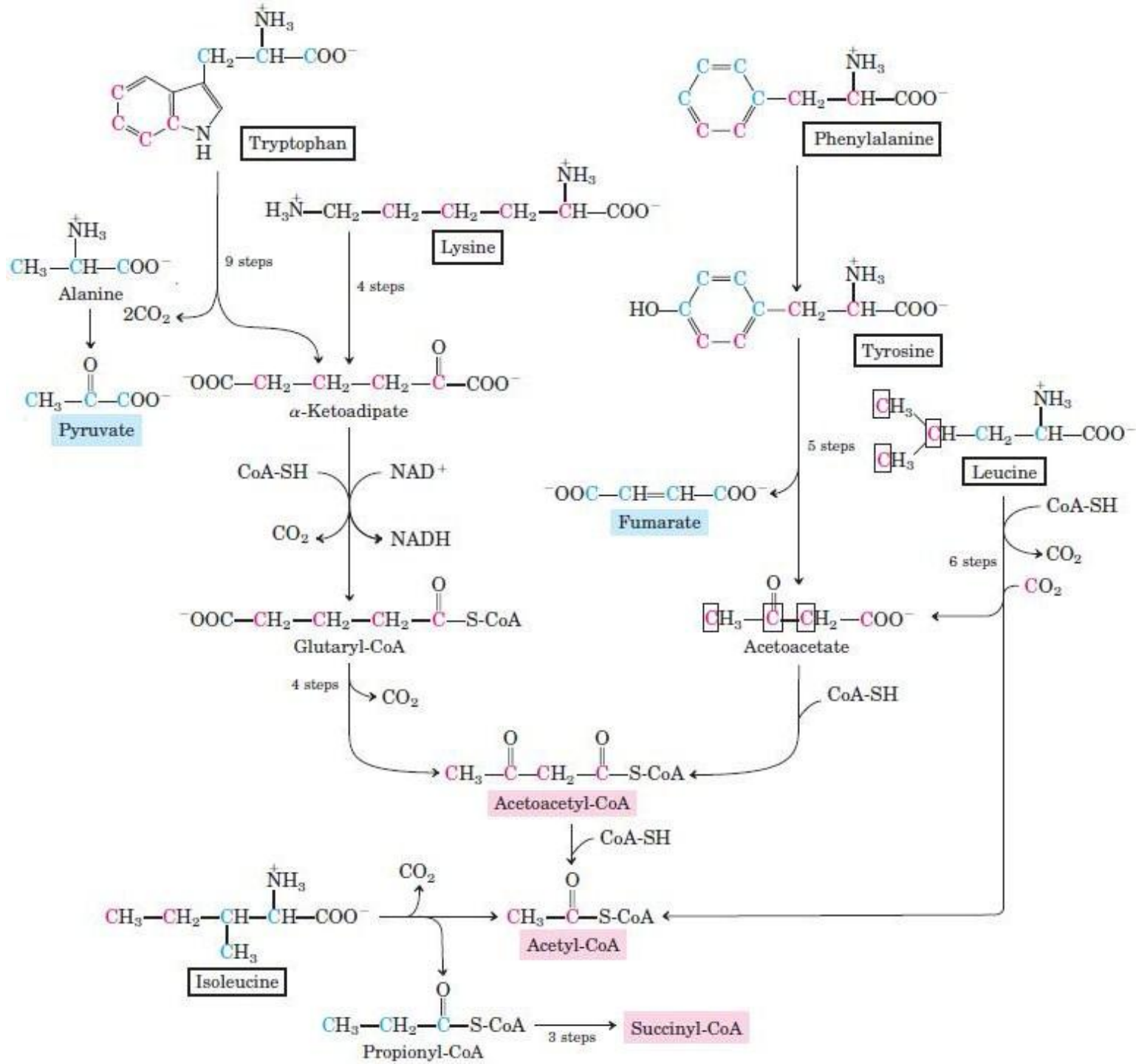

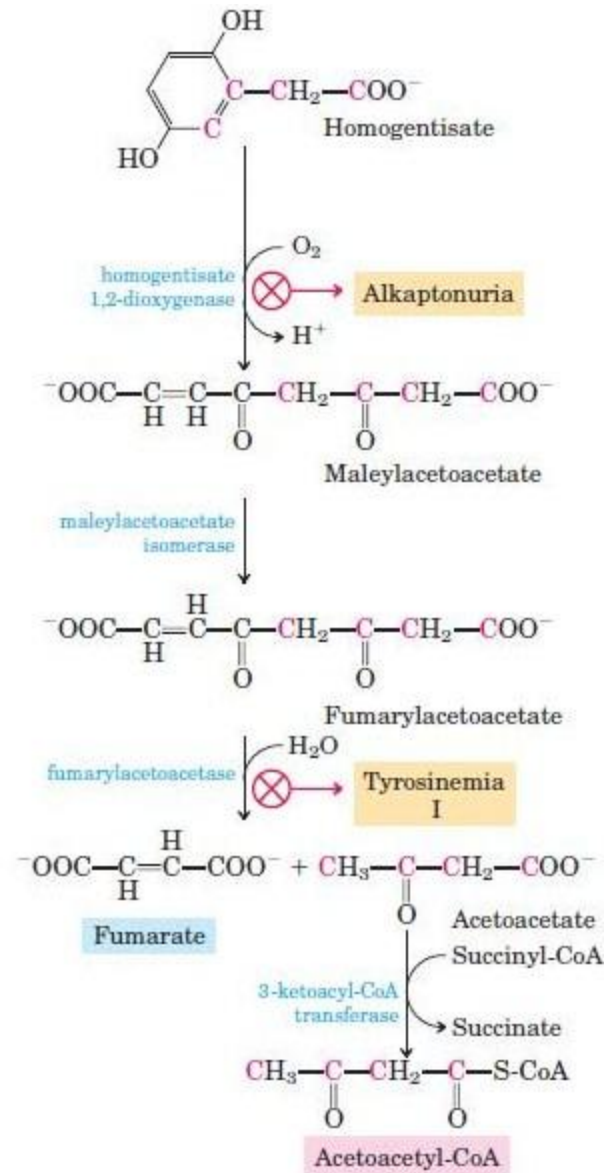
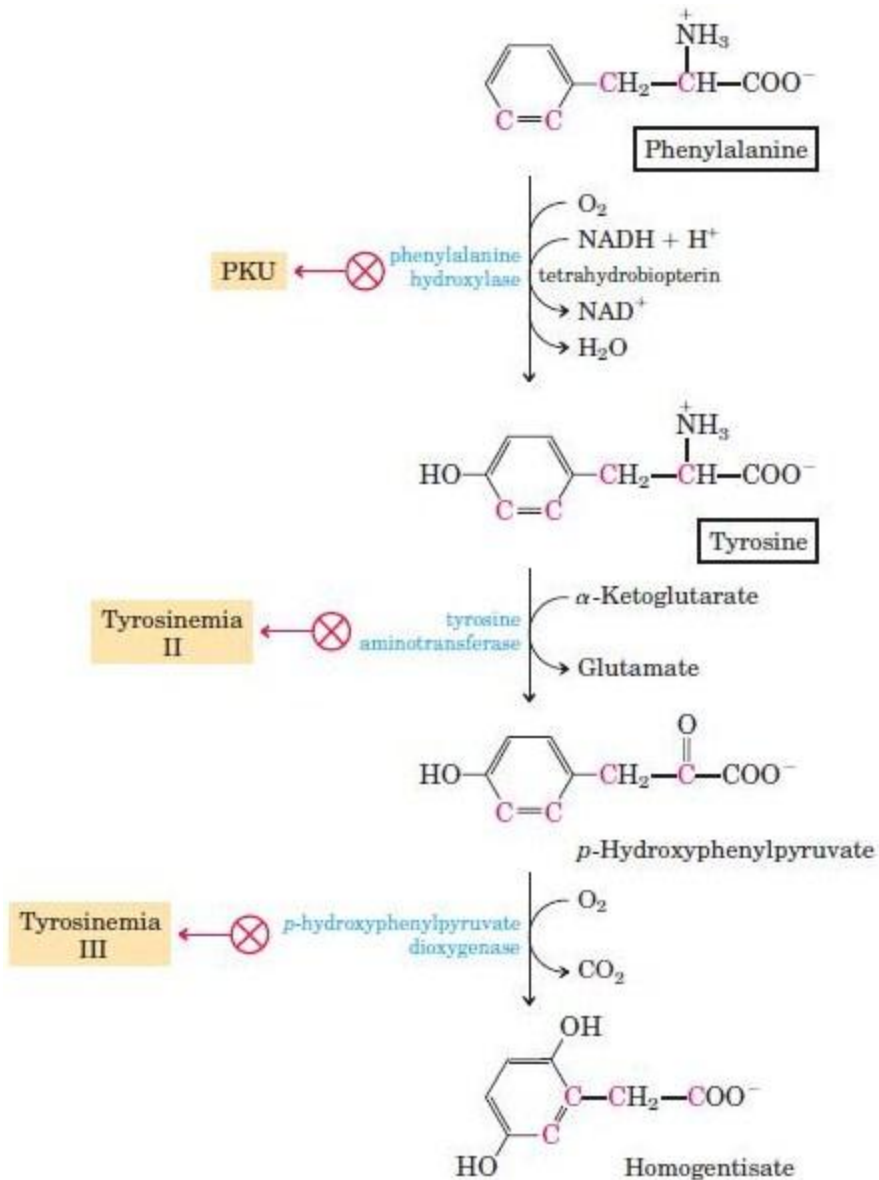

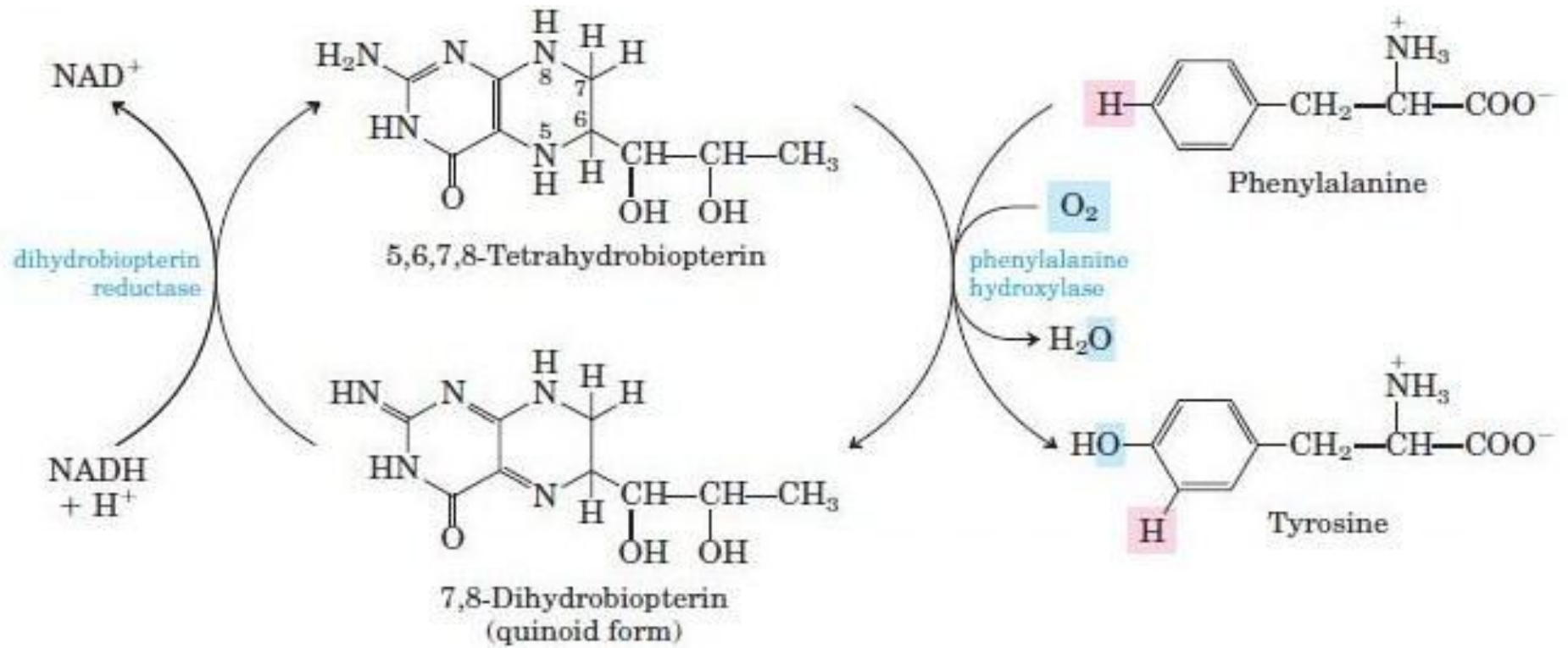

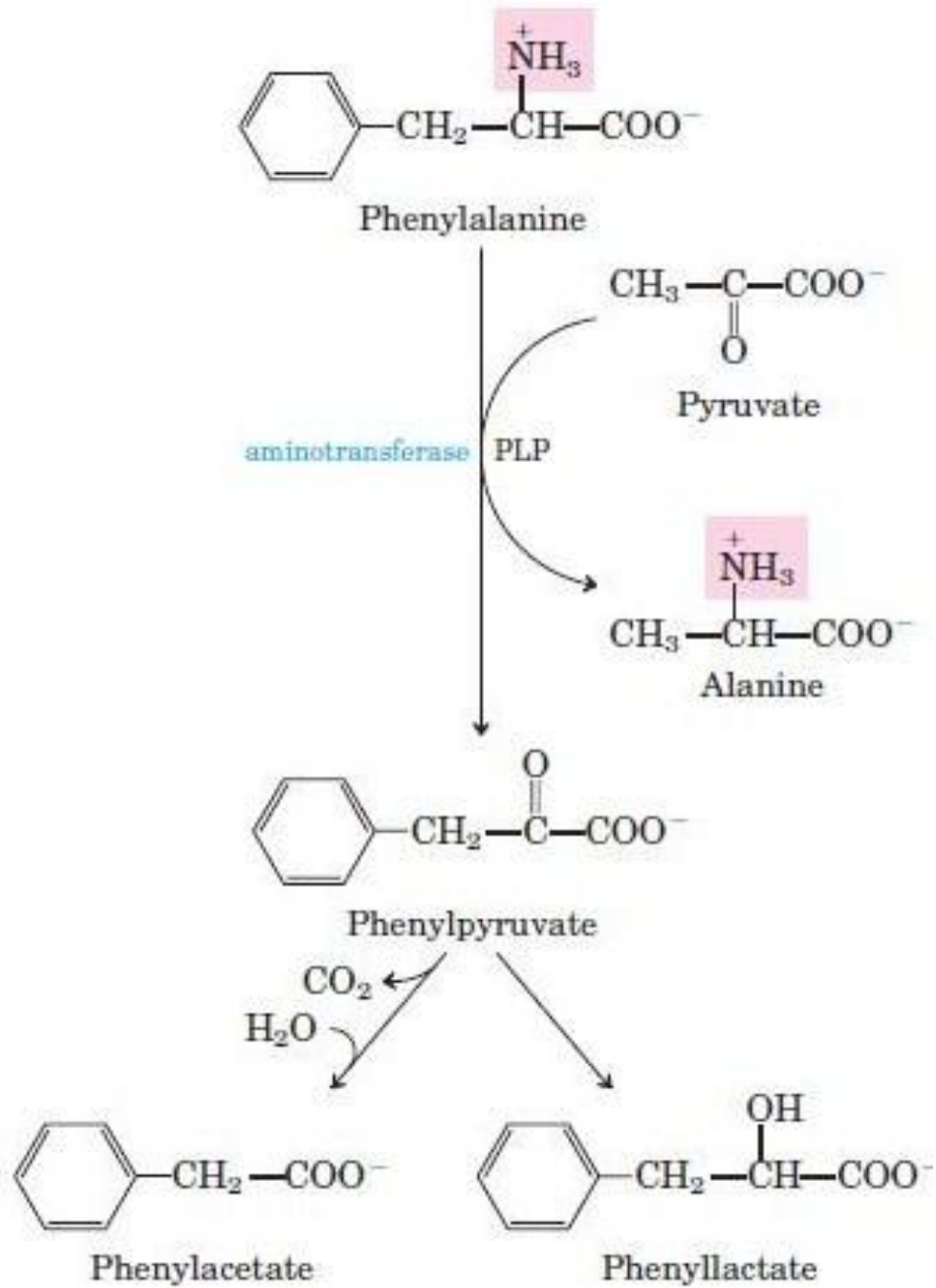

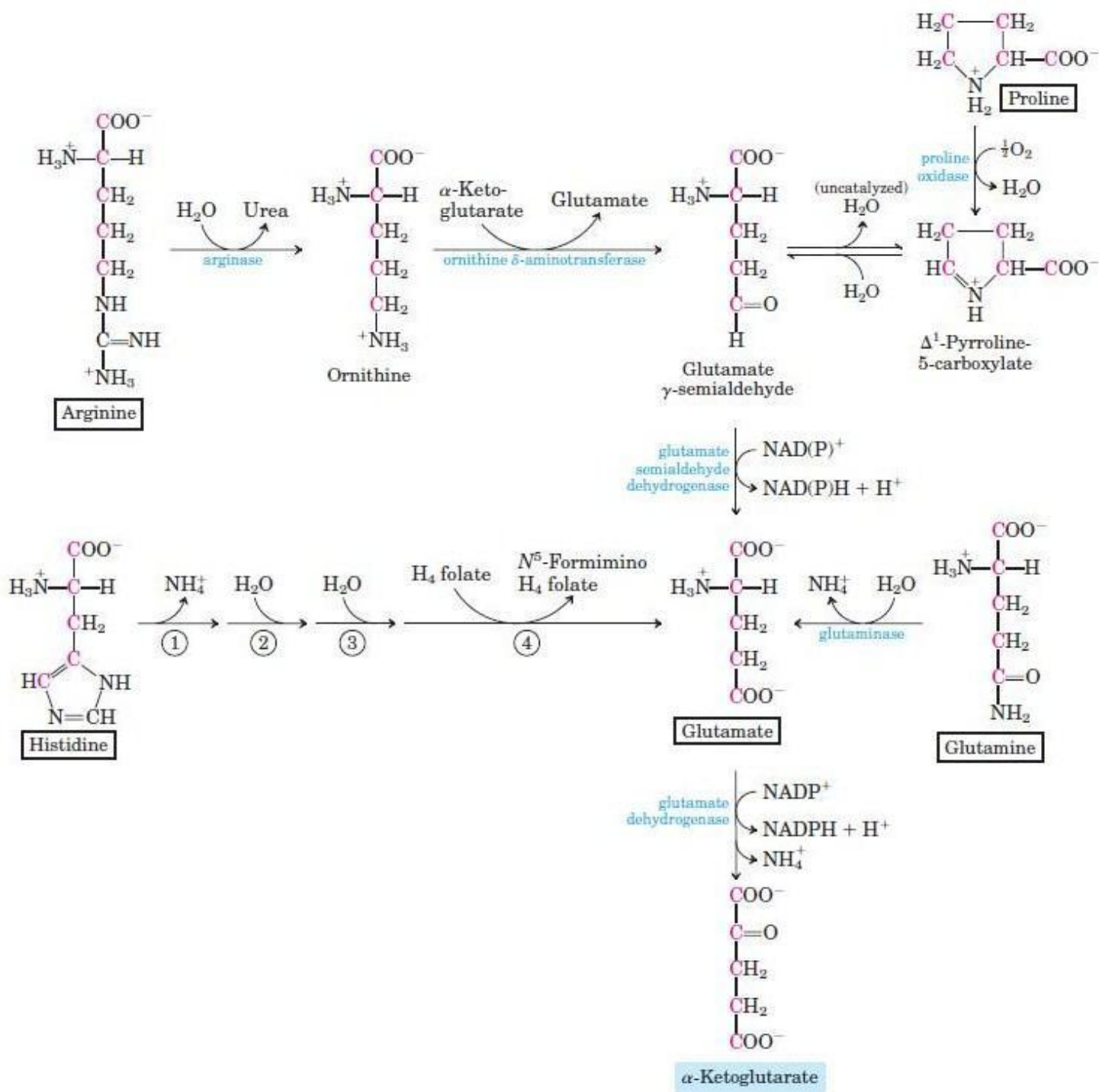

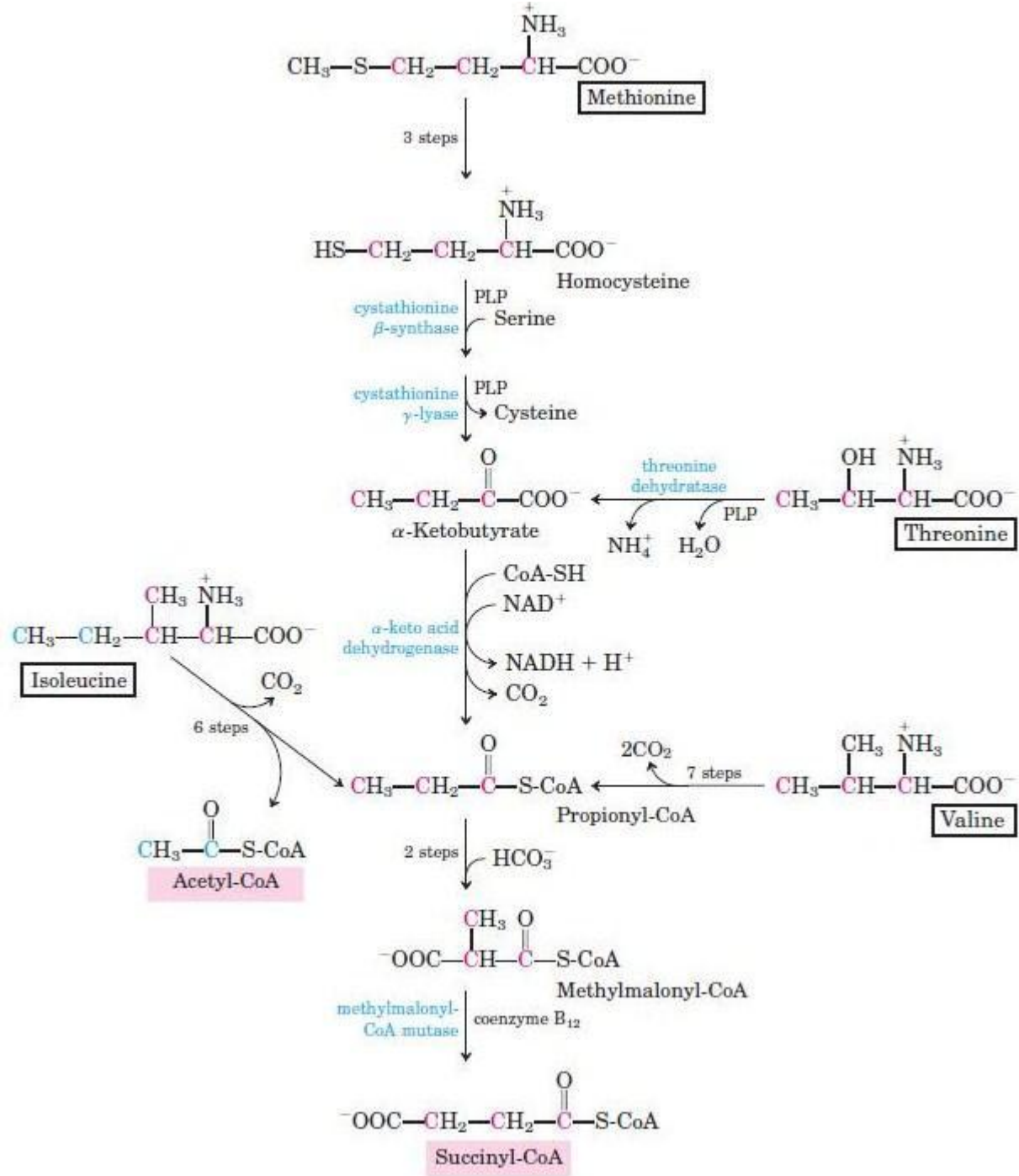

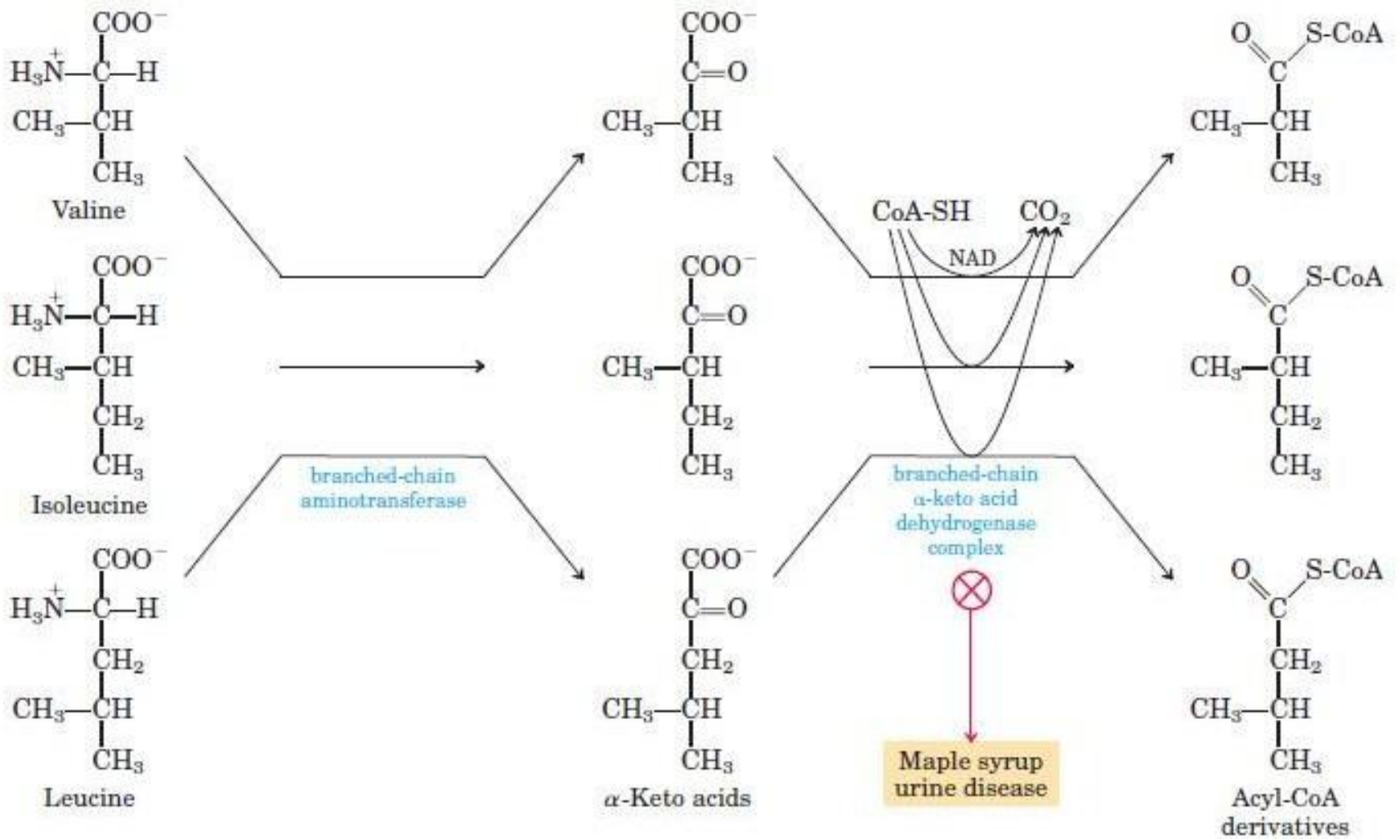

# Організація мембрани клітини

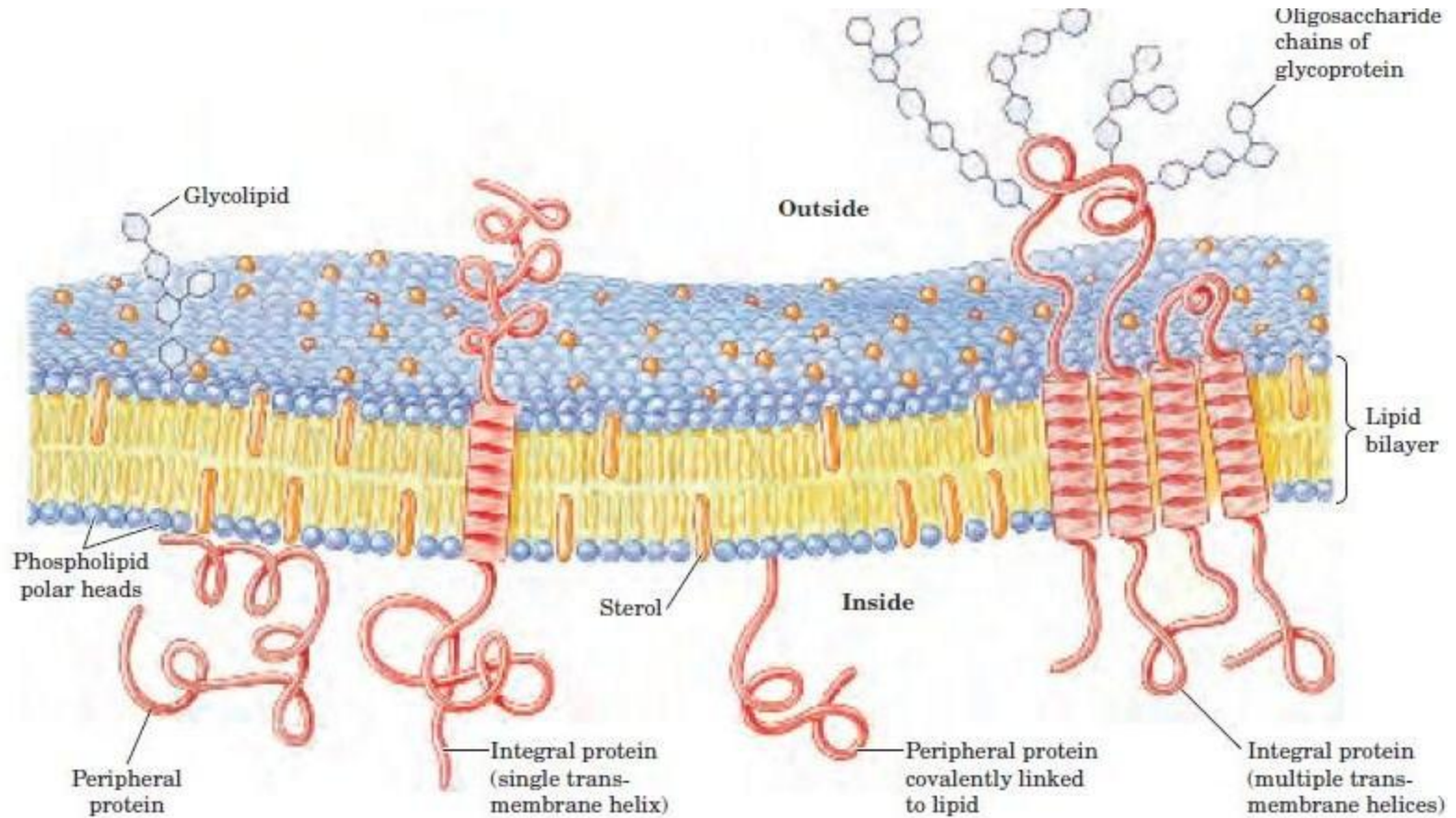



# Організація монофосфоліпідів



Individual units are wedge-shaped (cross section of head greater than that of side chain)

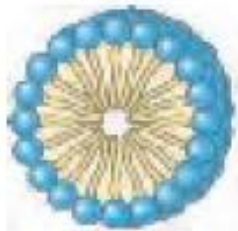

(a) Micelle



Individual units are cylindrical (cross section of head equals that of side chain)

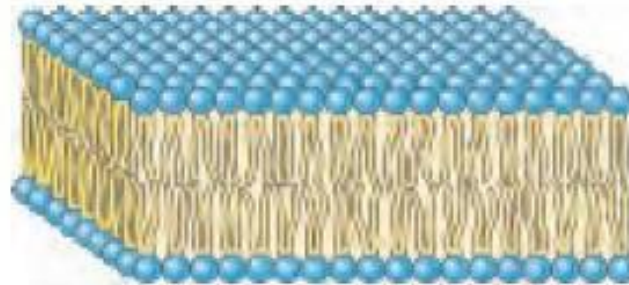

(b) Bilayer

Aqueous cavity

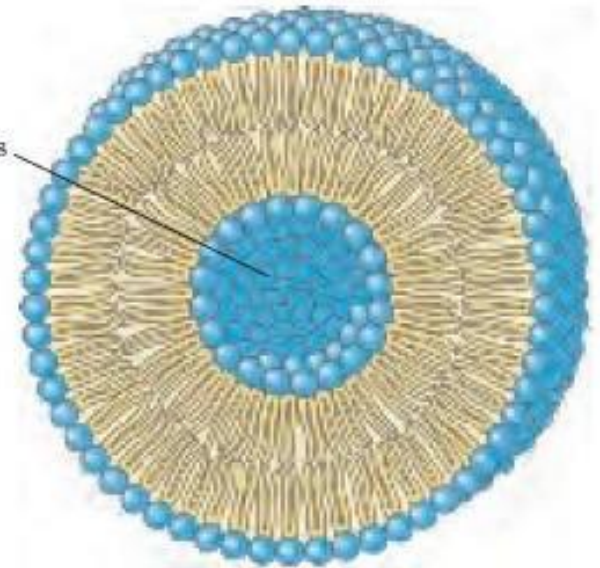

(c) Liposome

# **Наступна лекція**

**Тема: «Азотисті основи. Синтез білків»**

**Дата проведення: 9 вересня 2014 року**

*Пропозиції та побажання, а також  
заохочення та підтримку кидайте в урну*