

Авторський пілотний проект



Частина 1. Клітинна біохімія

Лекція 2. Метаболізм ліпідів.

Метаболізм білків. Стероїди

Ліпіди

Ліпіди – це група речовин, яка об'єднує у собі гідрофобні або амфіфільні речовини.

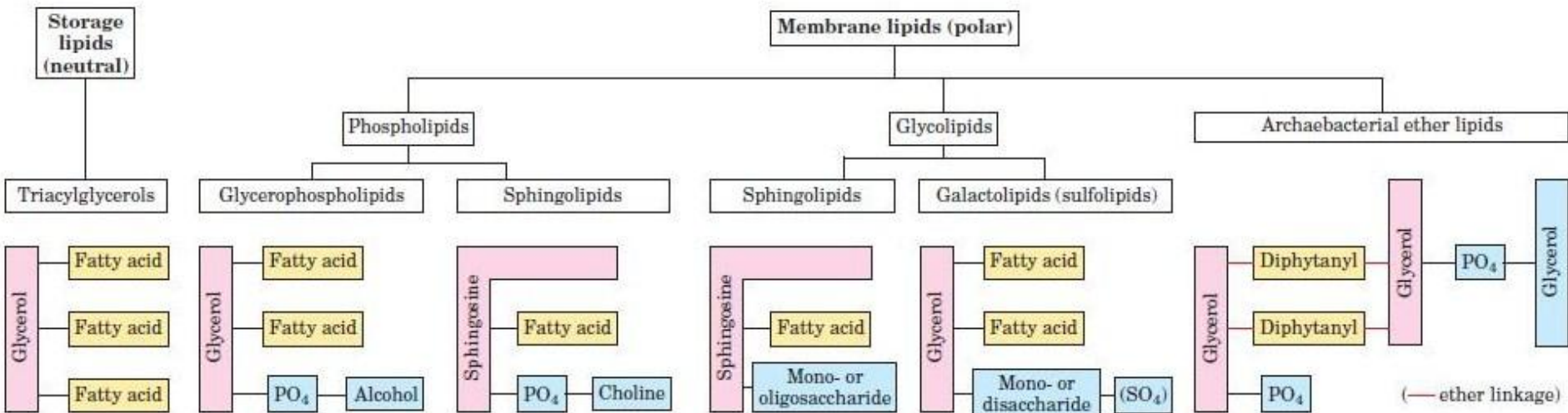

Органічні кислоти

Органічні кислоти – це кислоти, що мають за функціональну групу карбоксильну.

Вищі жирні кислоти – це органічні кислоти, що входять до складу жирів. Зазвичай це кислоти з парною кількістю Карбонів та їх кількістю не меншою за 16

(a) Carboxyl group

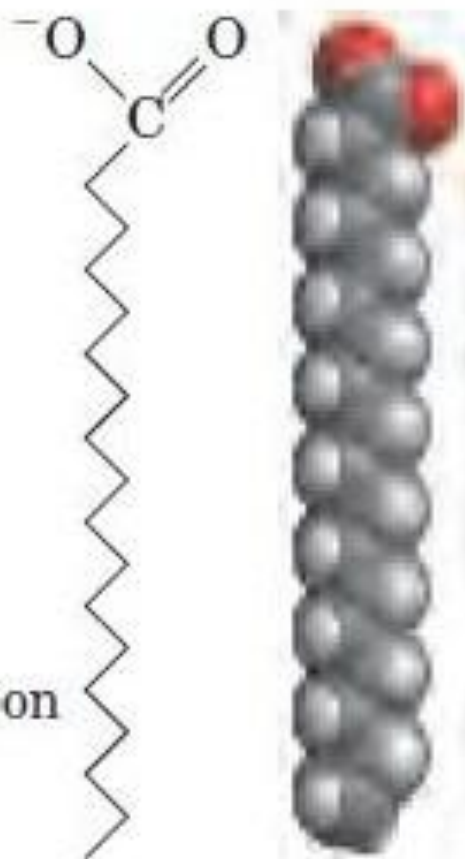

Hydrocarbon chain

(b)

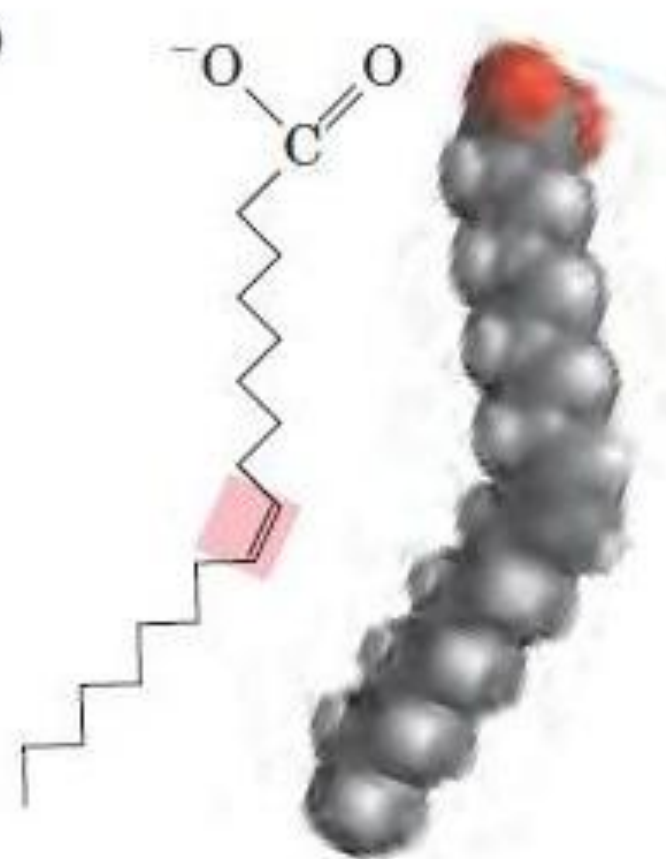

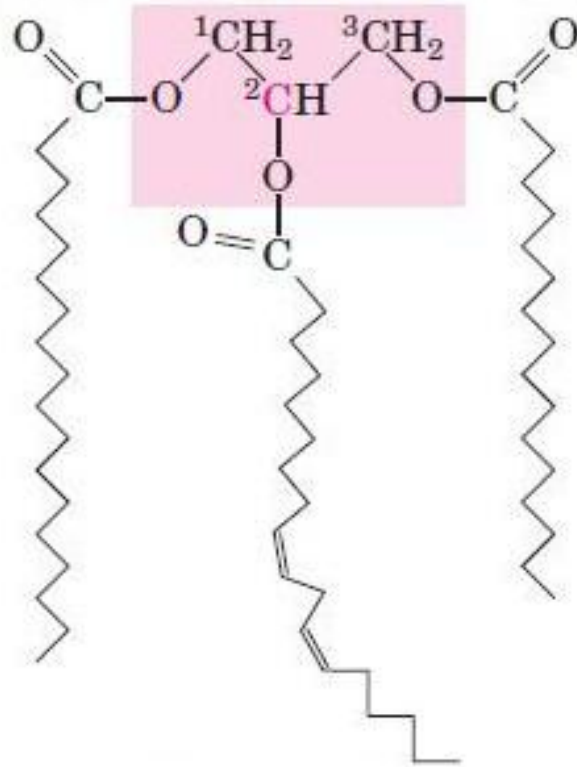

1-Stearoyl, 2-linoleoyl, 3-palmitoyl glycerol,
a mixed triacylglycerol

Гліцерофосфоліпіди

Основа

Glycerophospholipid
(general structure)

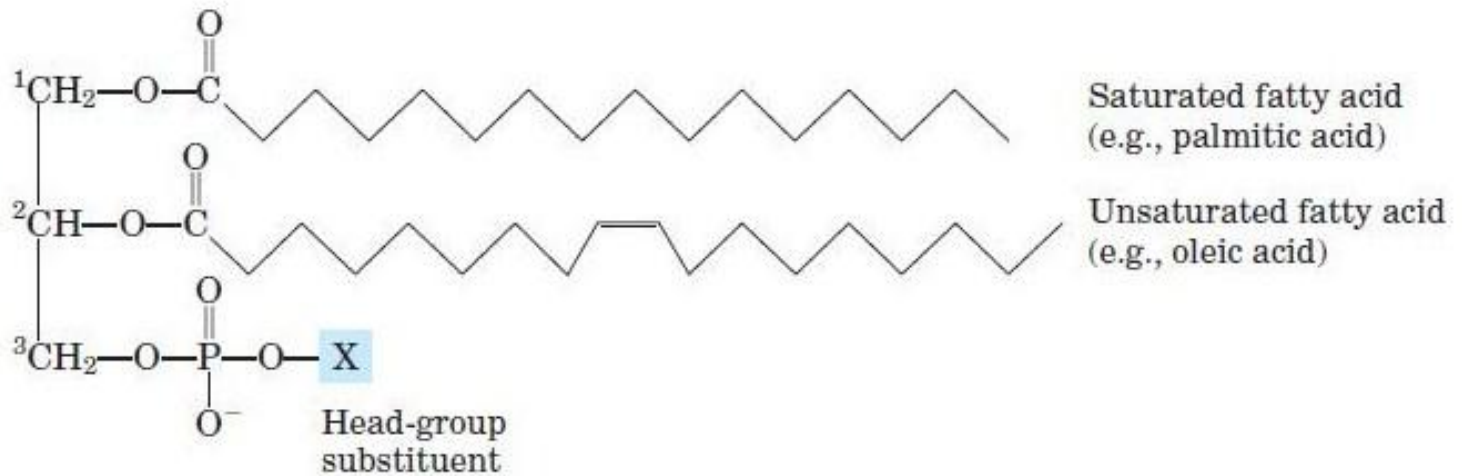



| Name of glycerophospholipid | Name of X | Formula of X | Net charge (at pH 7) |
|---------------------------------------|---------------------------------------|--|----------------------|
| Phosphatidic acid | — | — H | -1 |
| Phosphatidylethanolamine | Ethanolamine | — CH ₂ —CH ₂ —NH ₃ ⁺ | 0 |
| Phosphatidylcholine | Choline | — CH ₂ —CH ₂ —N ⁺ (CH ₃) ₃ | 0 |
| Phosphatidylserine | Serine | — CH ₂ —CH—NH ₃ ⁺ COO ⁻ | -1 |
| Phosphatidylglycerol | Glycerol | — CH ₂ —CH—CH ₂ —OH OH | -1 |
| Phosphatidylinositol 4,5-bisphosphate | <i>myo</i> -Inositol 4,5-bisphosphate | | -4 |
| Cardiolipin | Phosphatidylglycerol | | -2 |

Сфігноліпіди

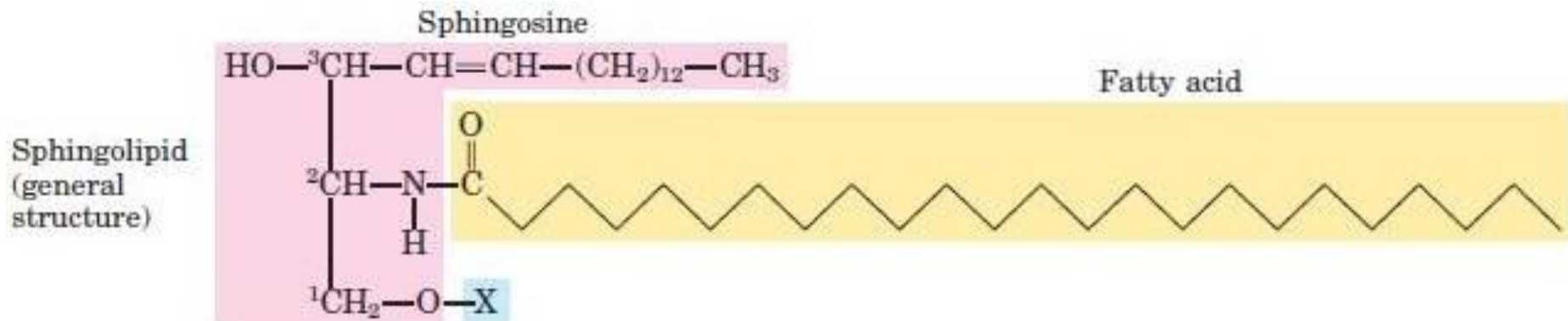
Основа

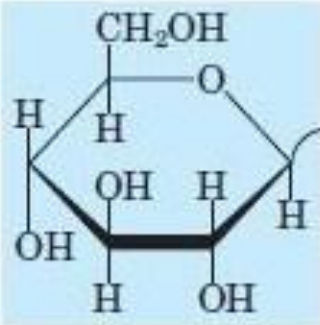

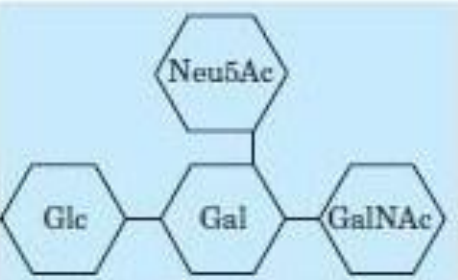
| Name of sphingolipid | Name of X | Formula of X |
|--|-------------------------------|--|
| Ceramide | — | — H |
| Sphingomyelin | Phosphocholine | $\begin{array}{c} \text{O} \\ \parallel \\ \text{— P — O — CH}_2\text{ — CH}_2\text{ — N}^+(\text{CH}_3)_3 \\ \parallel \\ \text{O}^- \end{array}$ |
| Neutral glycolipids Glucosylcerebroside | Glucose |  |
| Lactosylceramide (a globoside) | Di-, tri-, or tetrasaccharide |  |
| Ganglioside GM2 | Complex oligosaccharide |  |

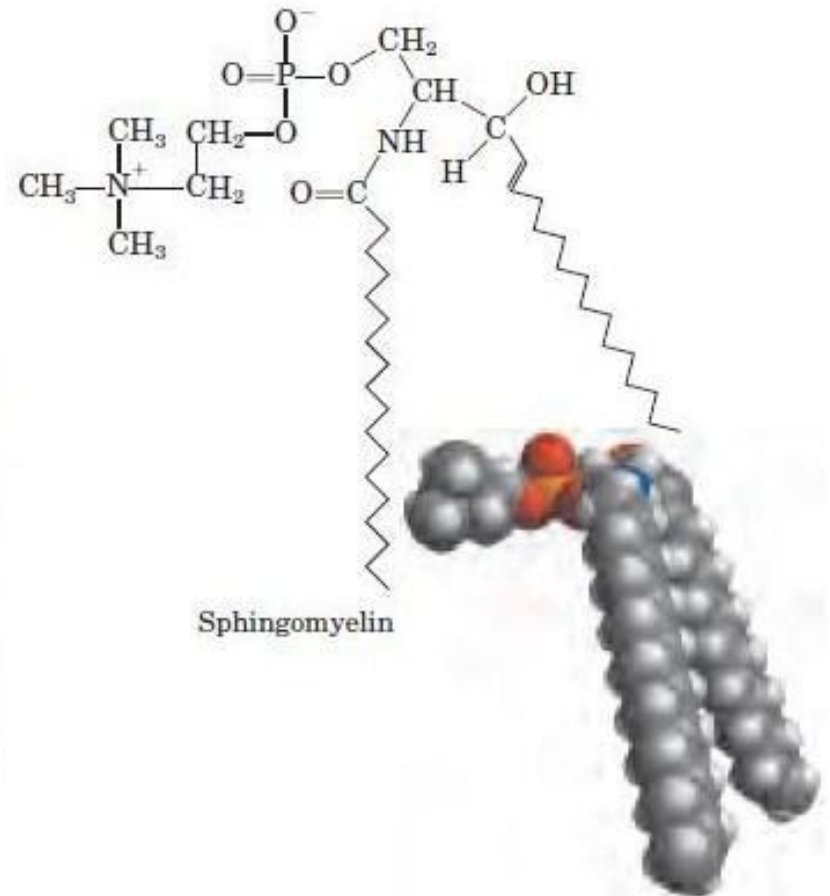
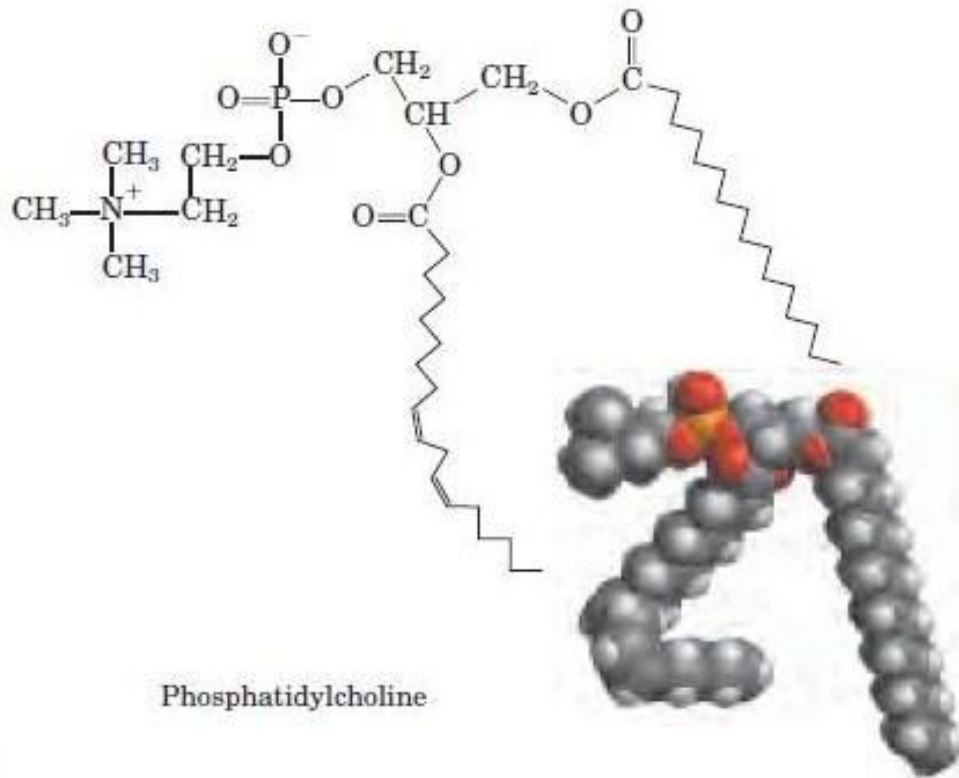

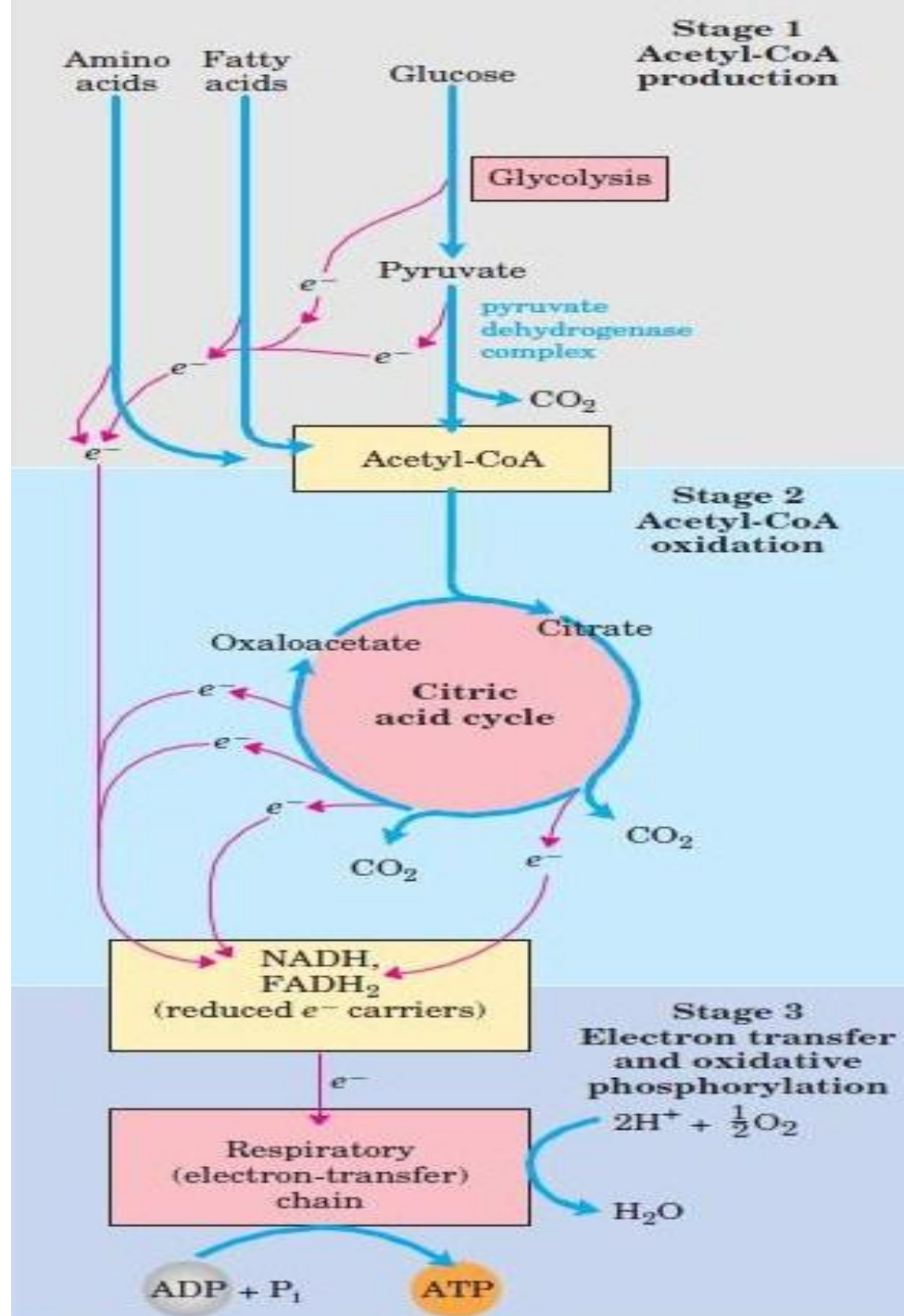

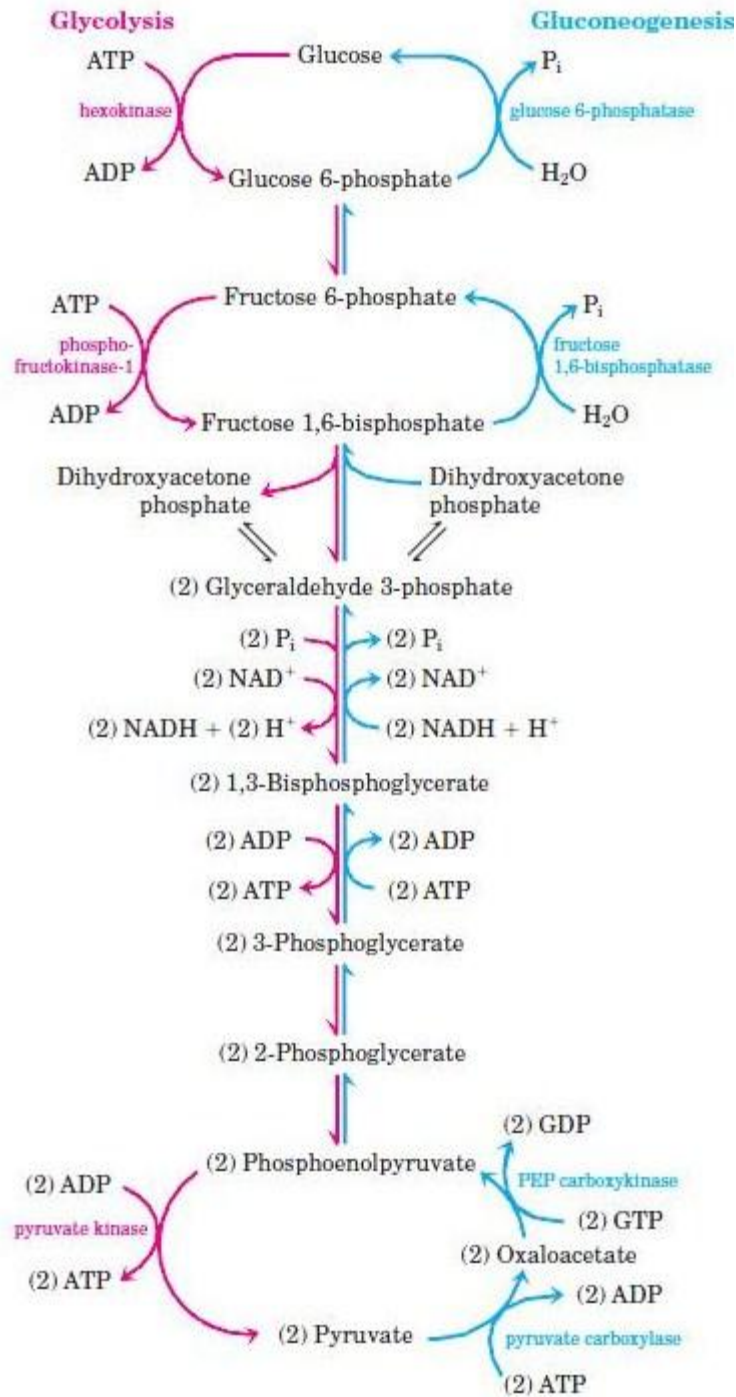

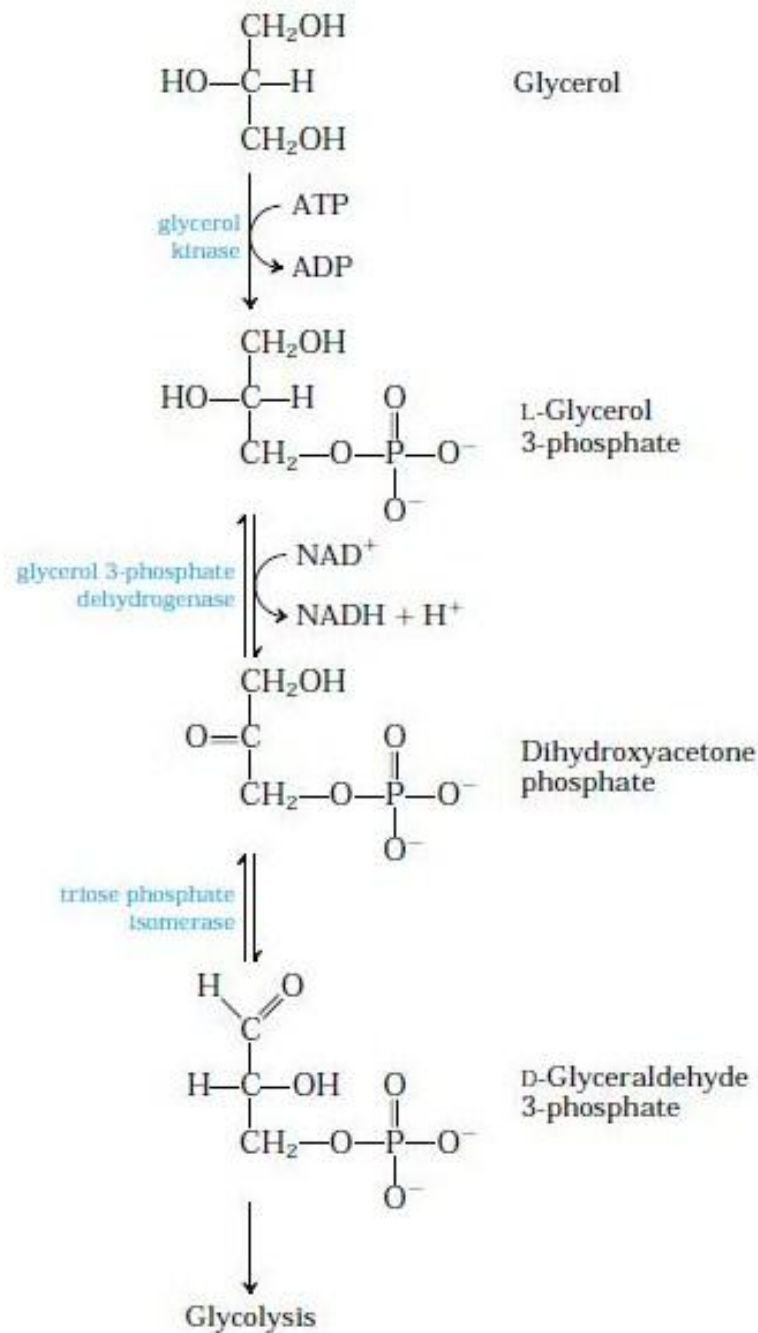

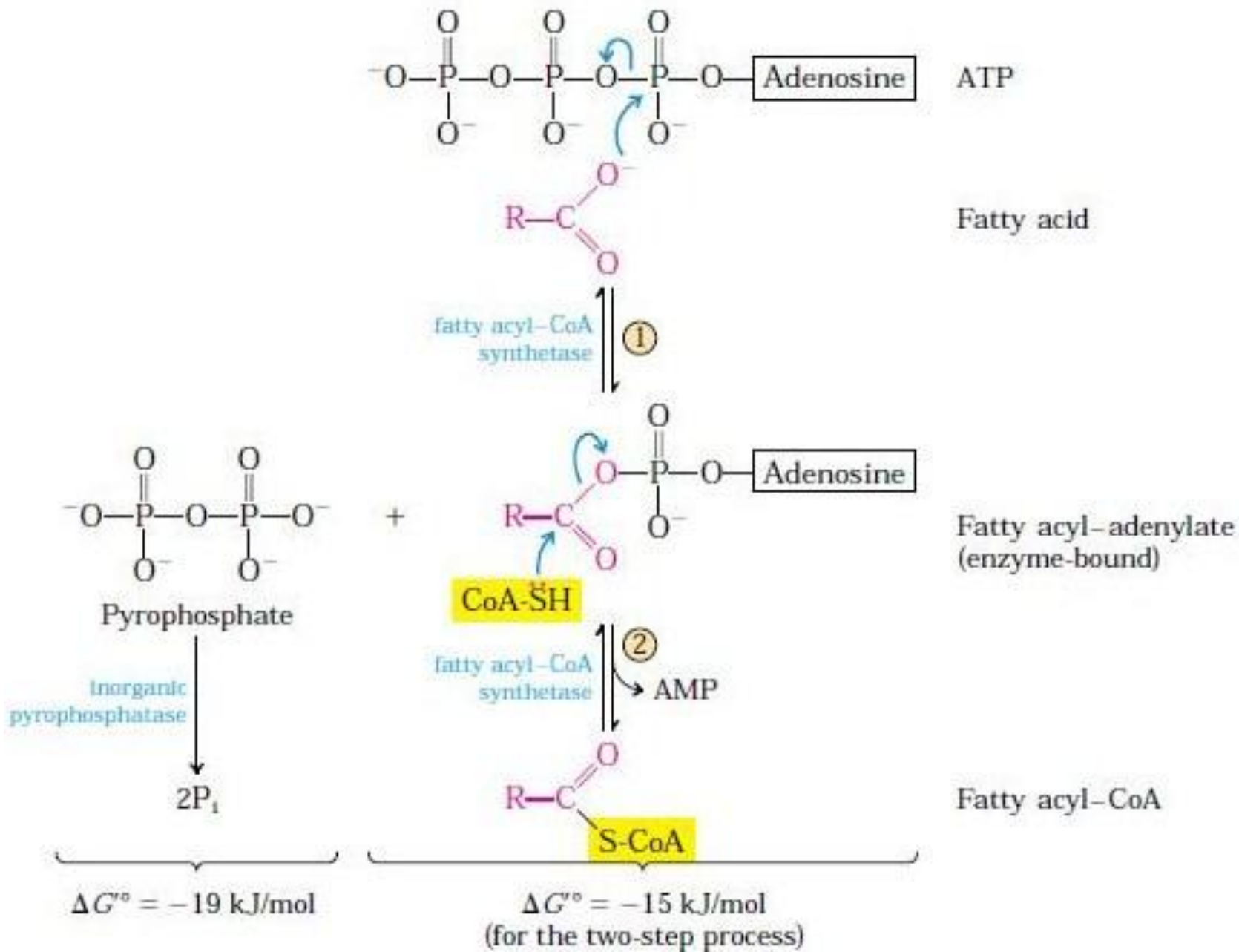

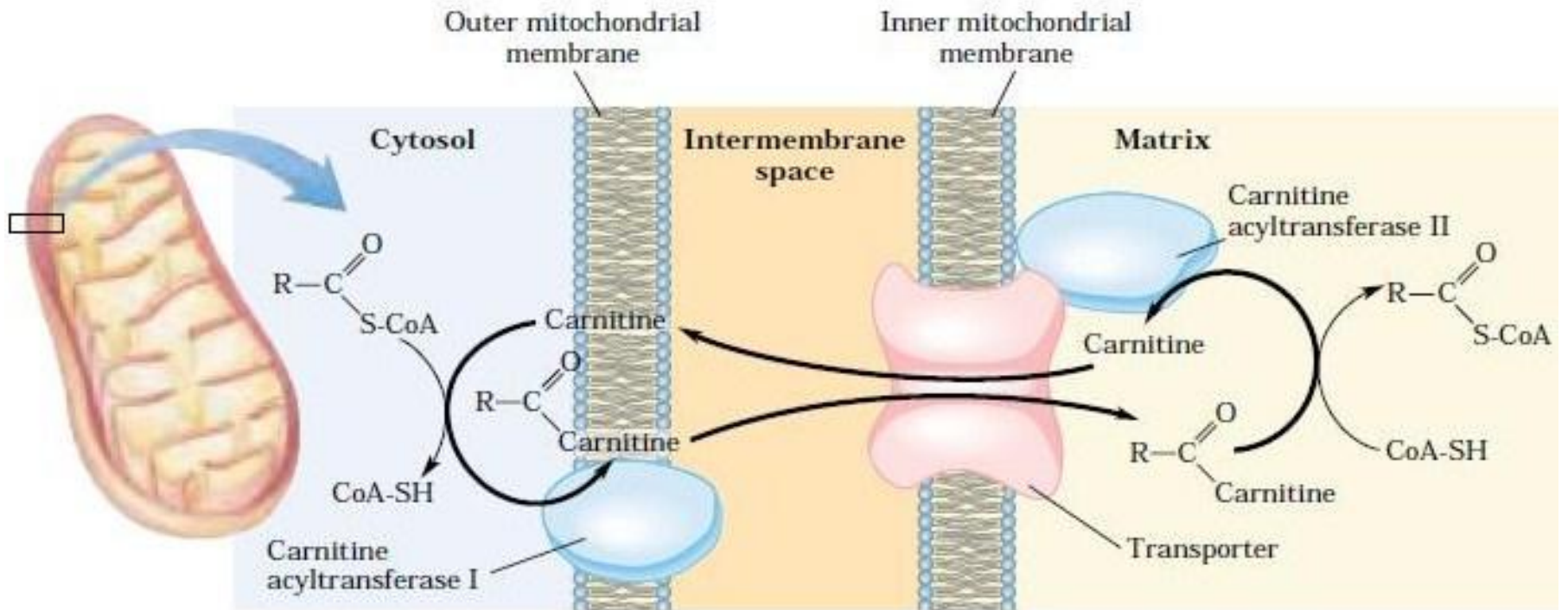

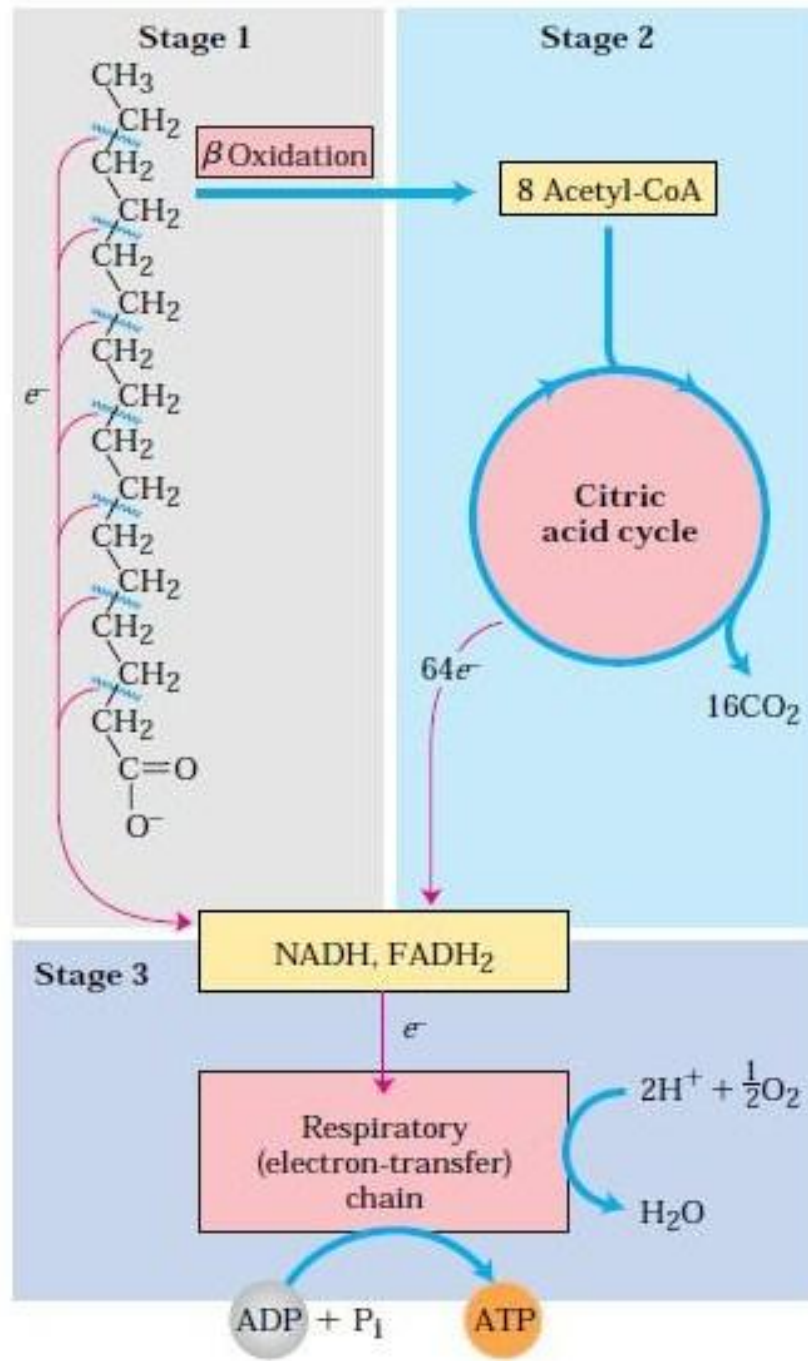

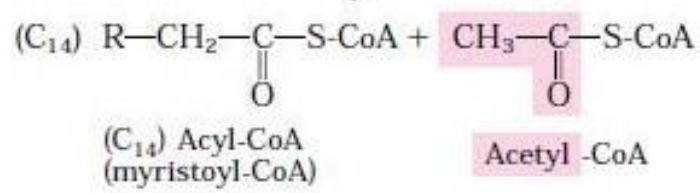
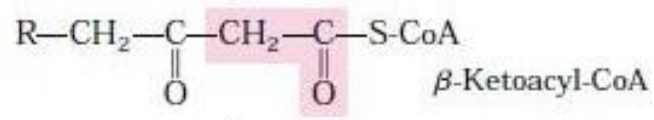
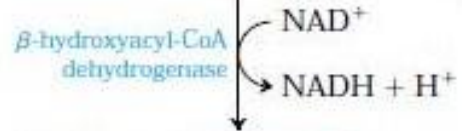
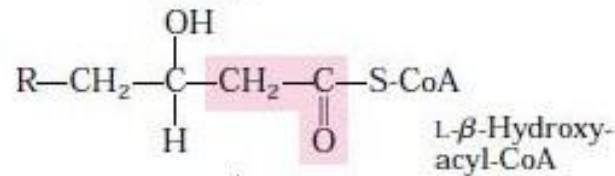
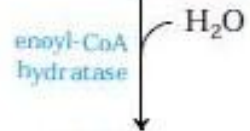
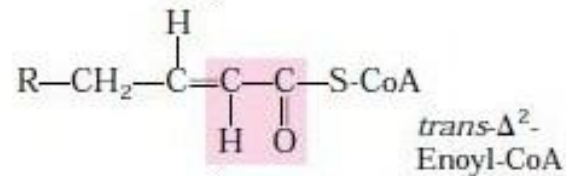
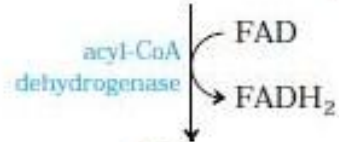
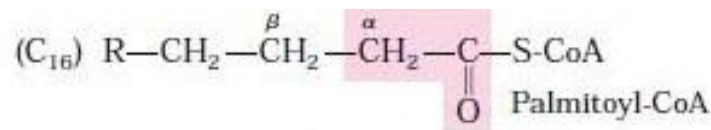

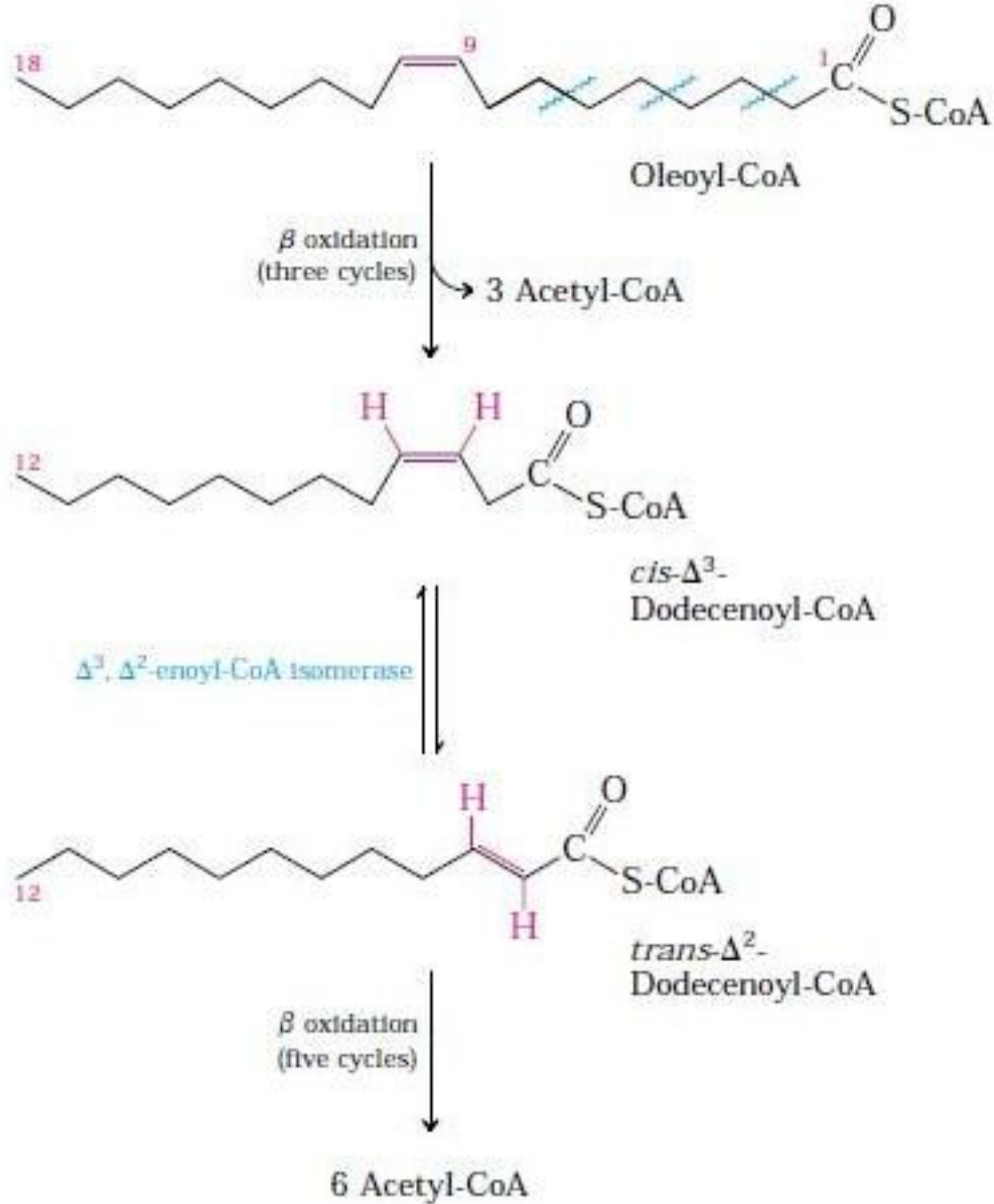

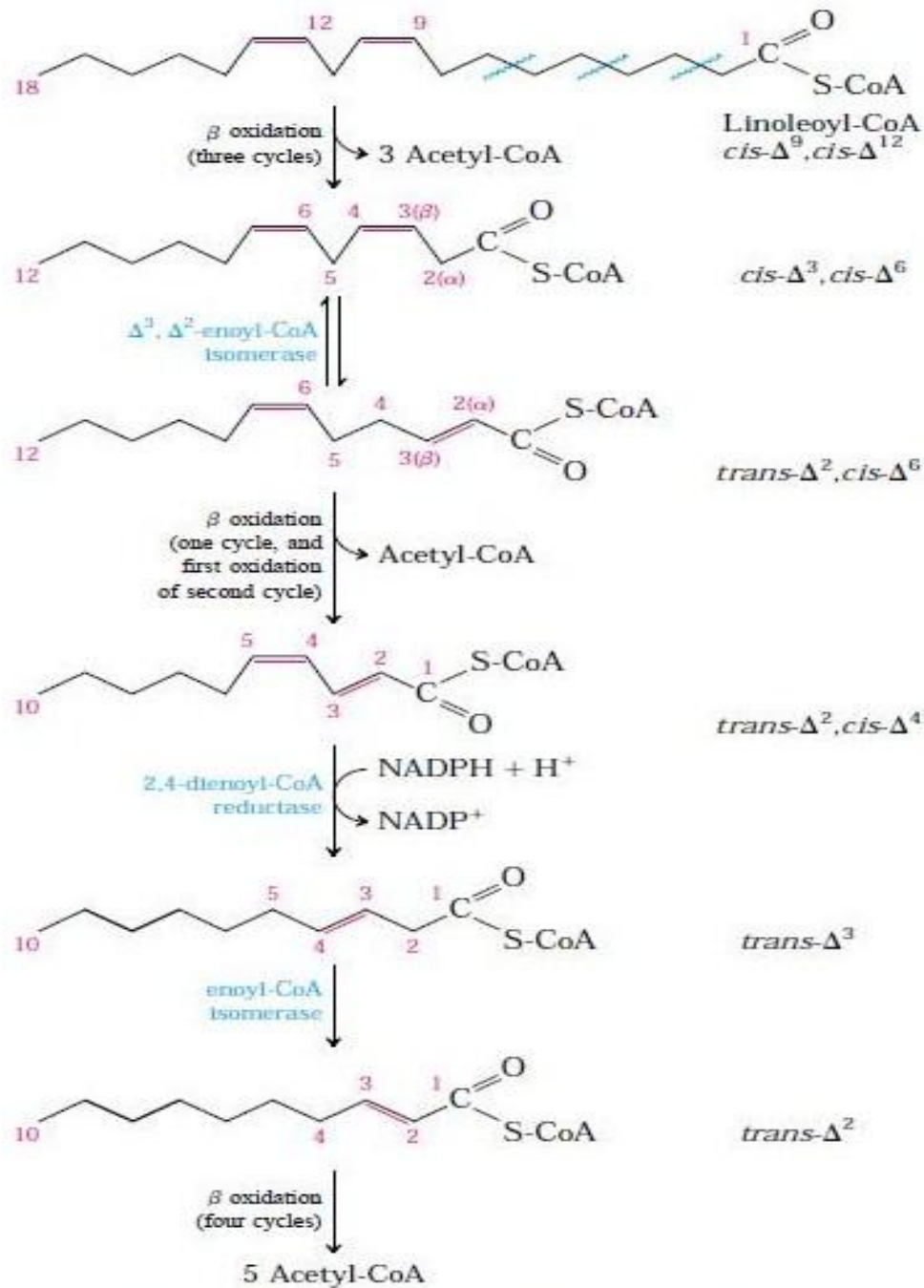

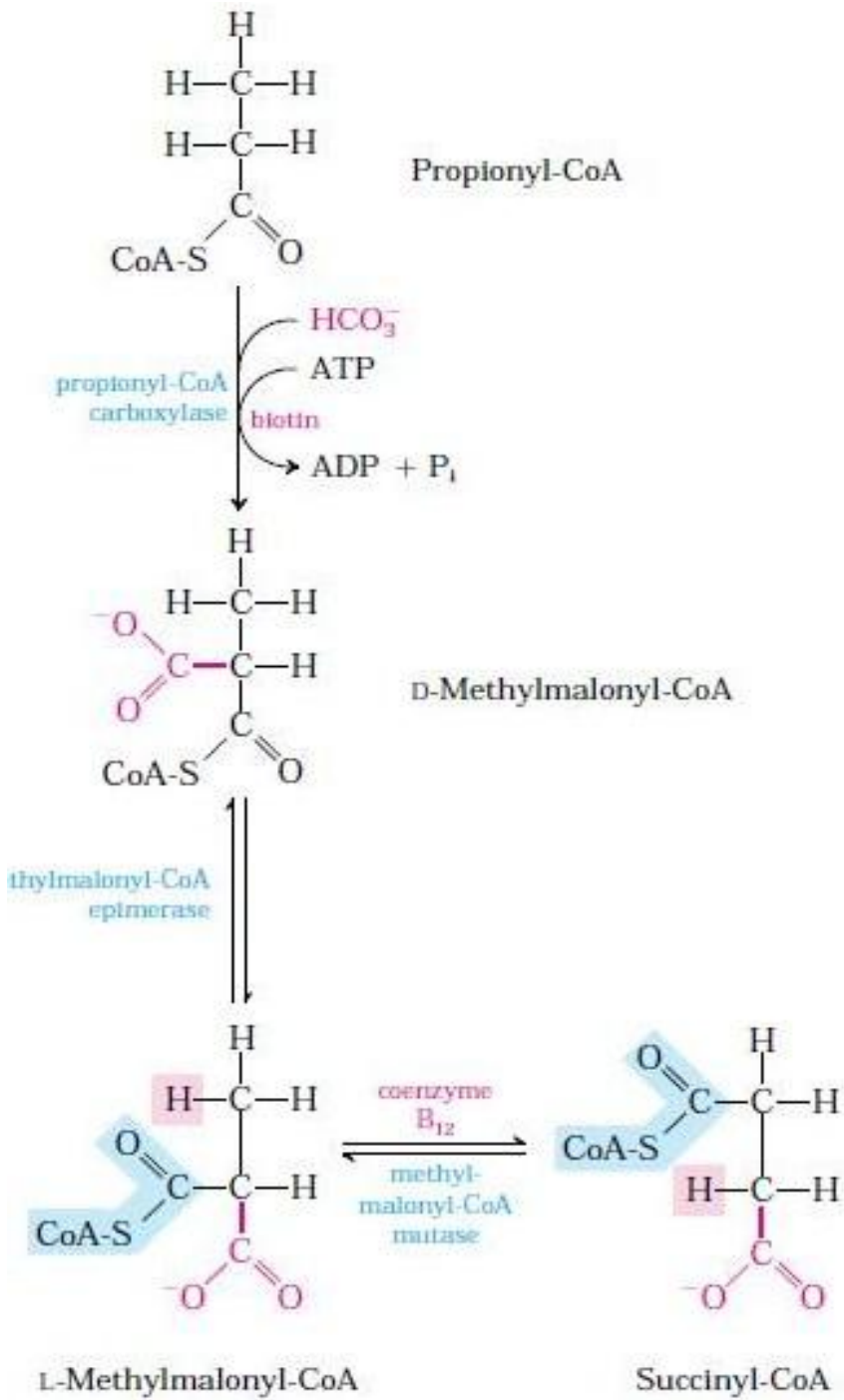

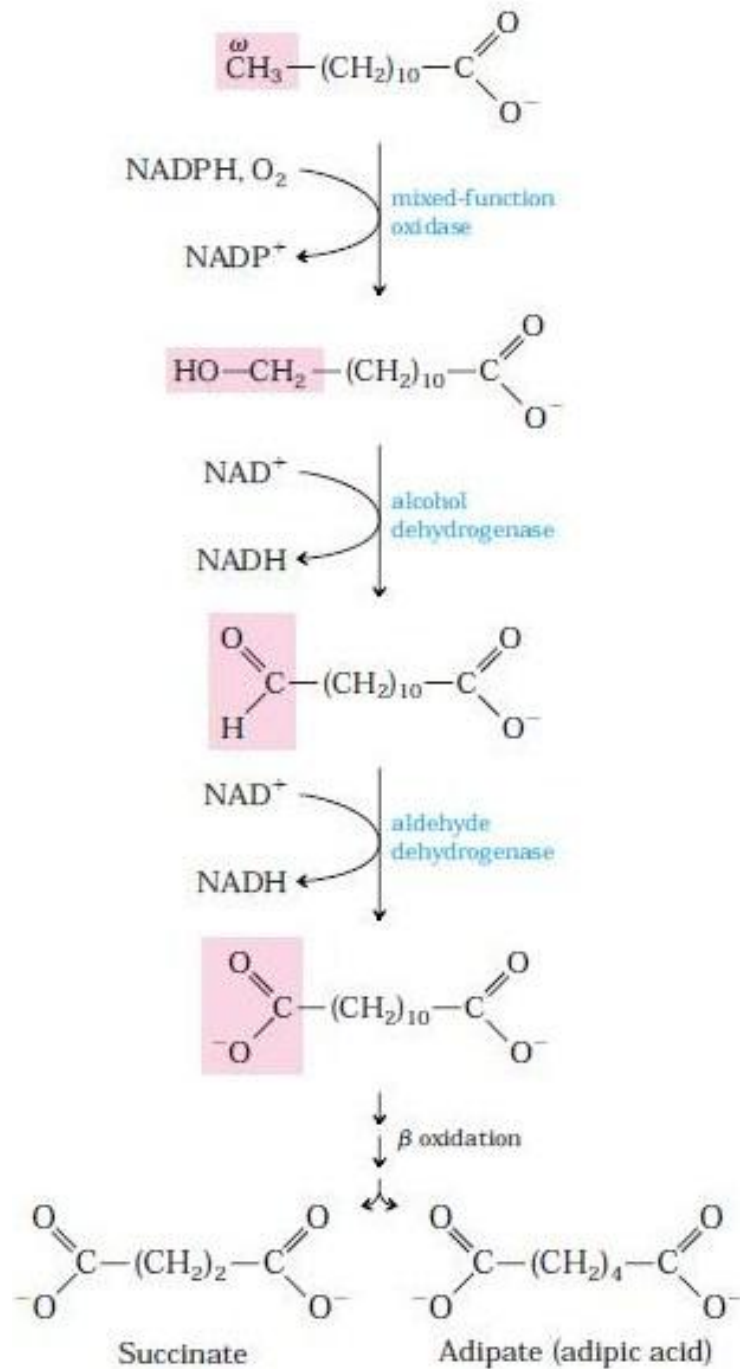

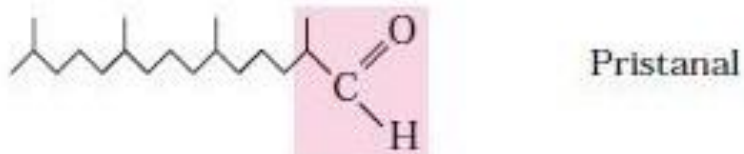
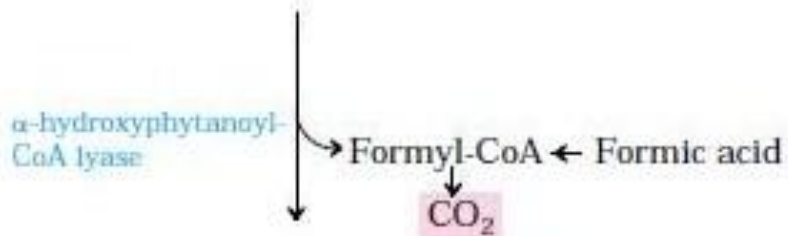
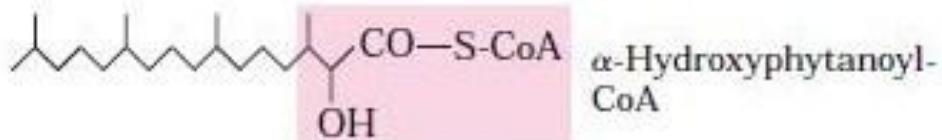
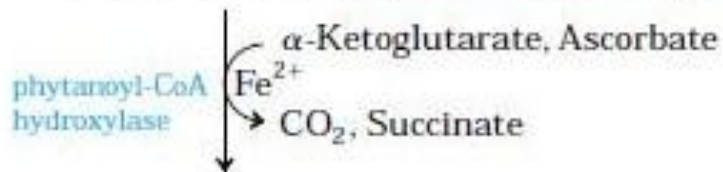
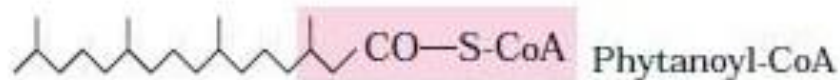
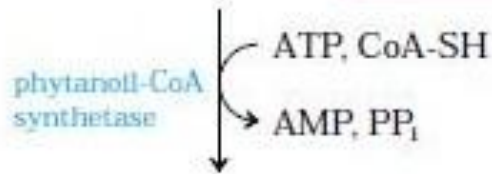
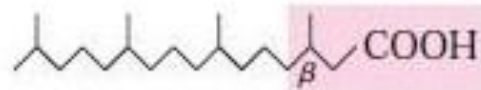

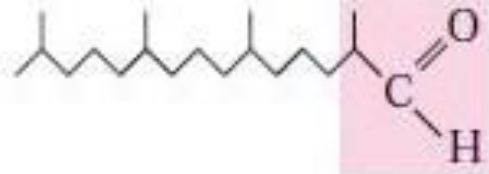

Pristanal

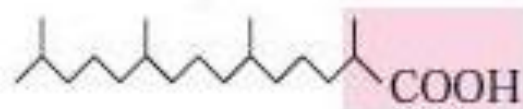
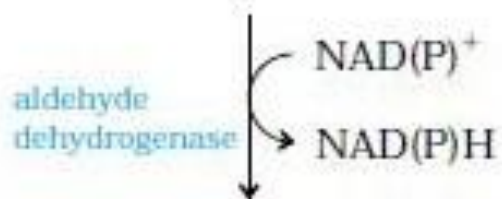

Pristanic acid

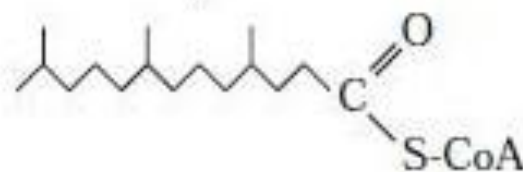
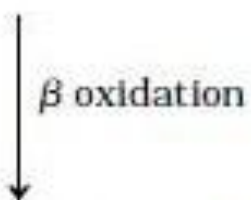

4,8,12-Trimethyltridecanoyl-CoA

+

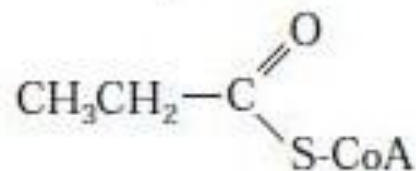

Propionyl-CoA

Згадаємо ще раз...

Кетогенез – процес утворення кетонових тіл. Кетонові тіла утворюються в організмі тоді, коли є недостаток мономерних вуглеводів, і наявний надлишок АКоА. В даному випадку його треба “ліквідувати” – і АКоА спонтанно декарбоксилюється, запускаючи кетогенез.

В організмі людини виділяють 3 основних кетонових тіла: ацетон, ацетооцтова кислота, гамма-оксимасляна кислота (γ-оксибутаноат)

Разом з тим...

Кетогенез – це не лише спосіб позбавлення від “зайвого” АКоА. Це також спосіб транспортувати його за межі мітохондрії і взагалі, за межі клітини, якщо субстрат потребують інші клітини. Цей процес більш економний, на відміну від глюконеогенезу, бо займає менше часу.

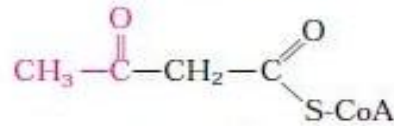
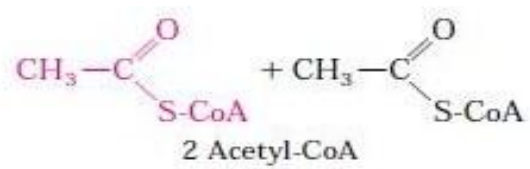

Acetoacetyl-CoA

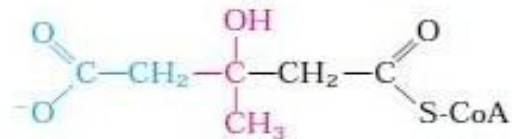

β -Hydroxy- β -methylglutaryl-CoA
(HMG-CoA)

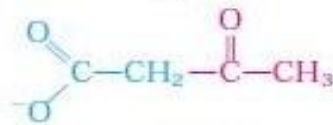

Acetoacetate

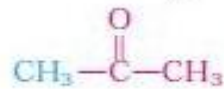

Acetone

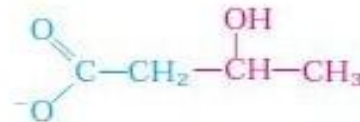
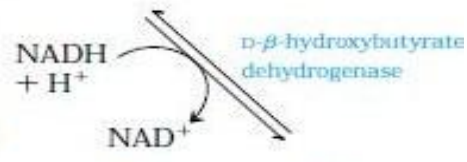

D- β -Hydroxybutyrate

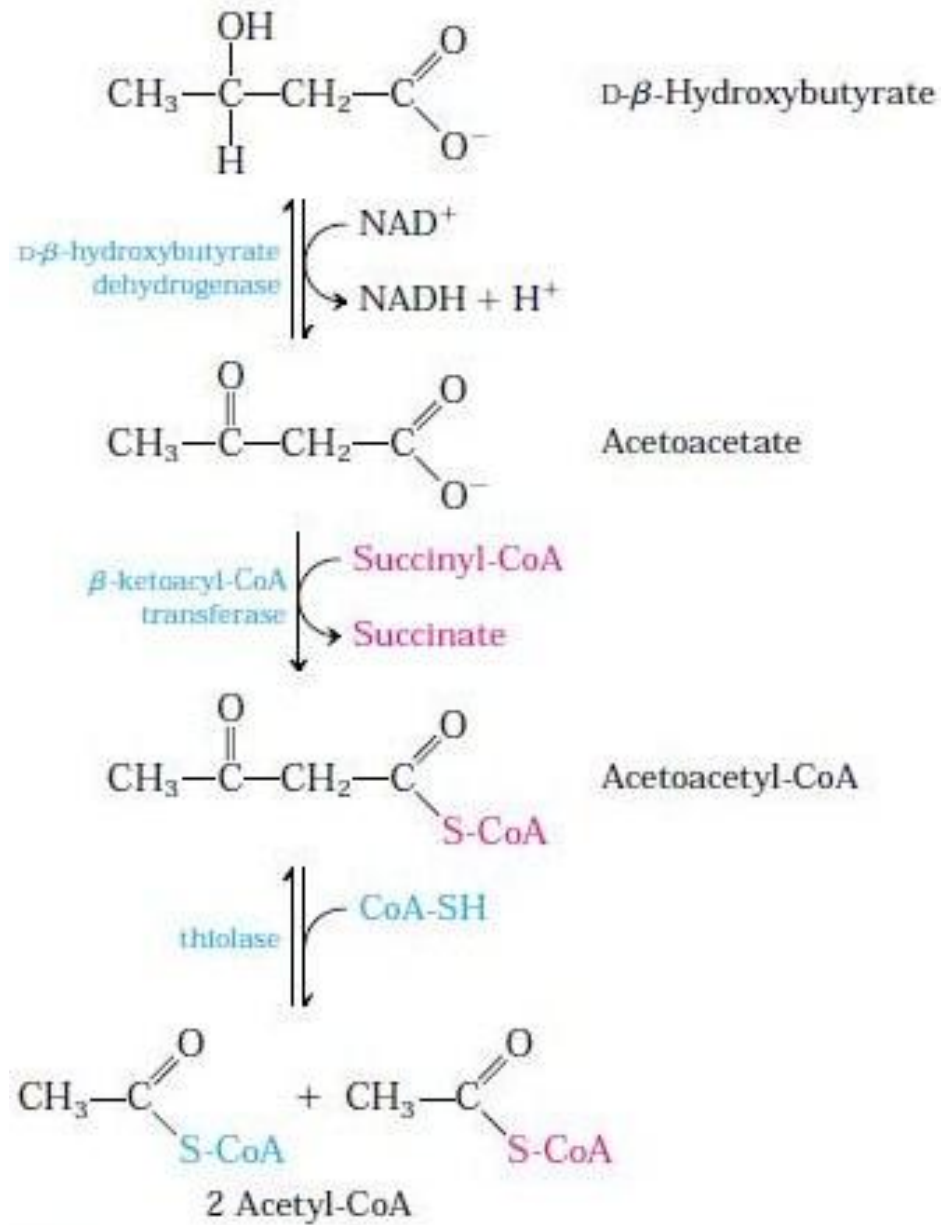

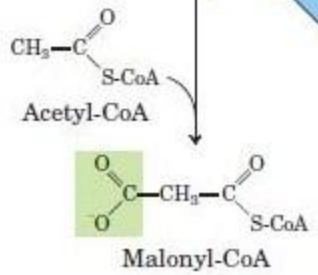
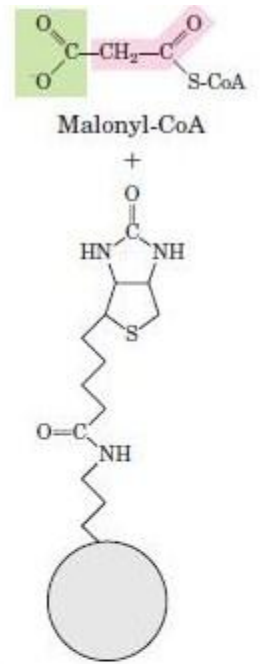
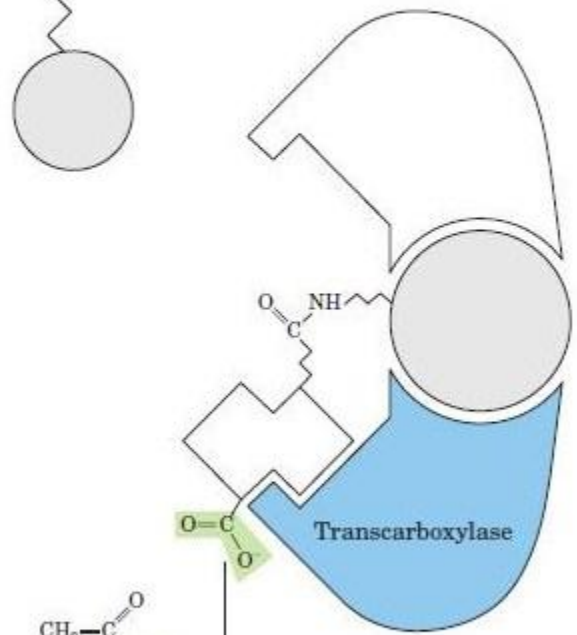
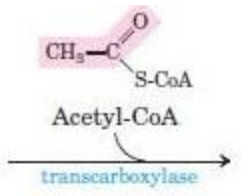
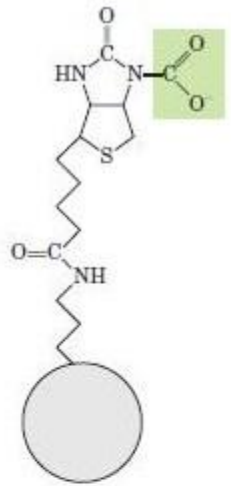
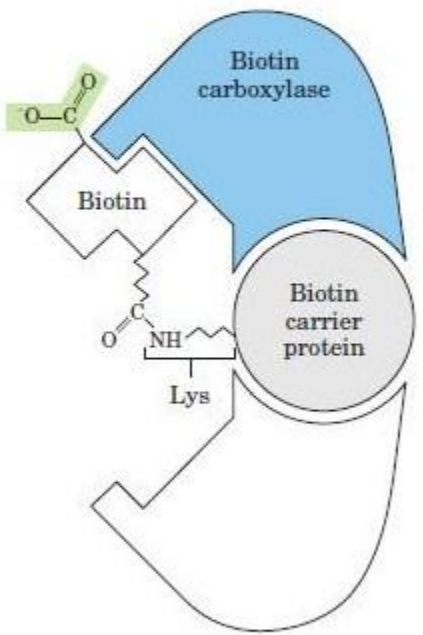
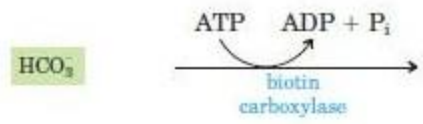
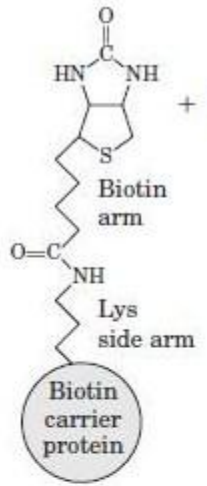

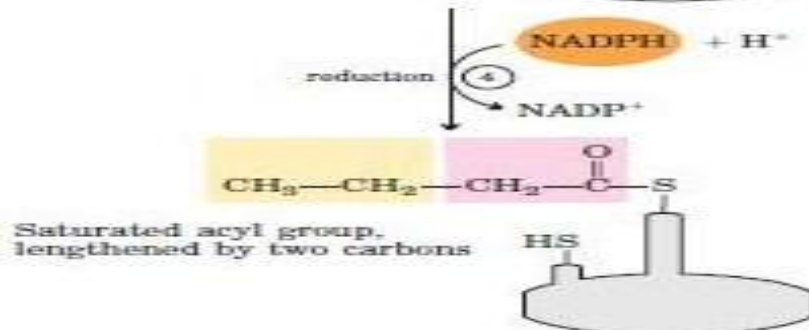
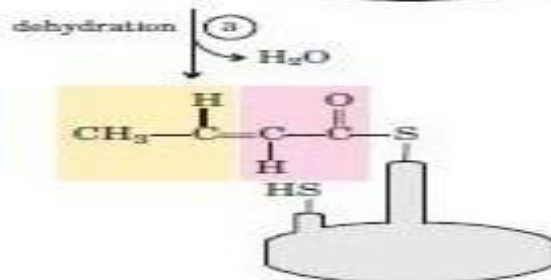
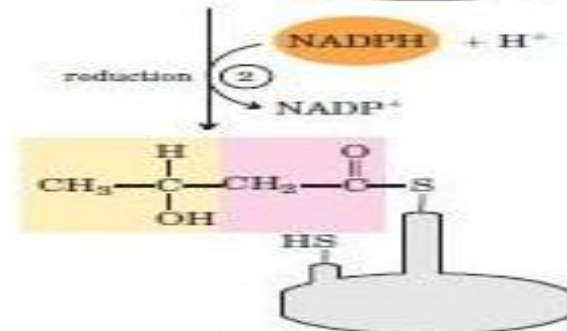
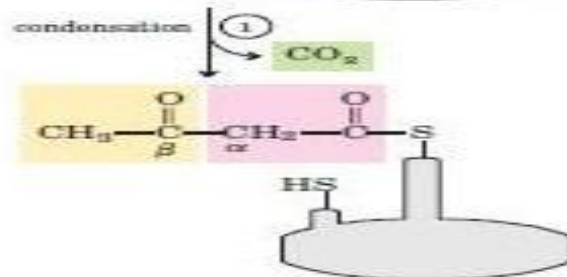
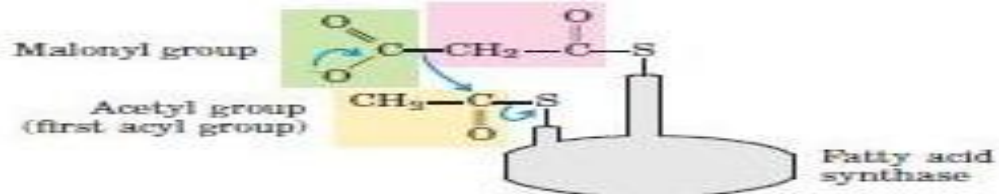

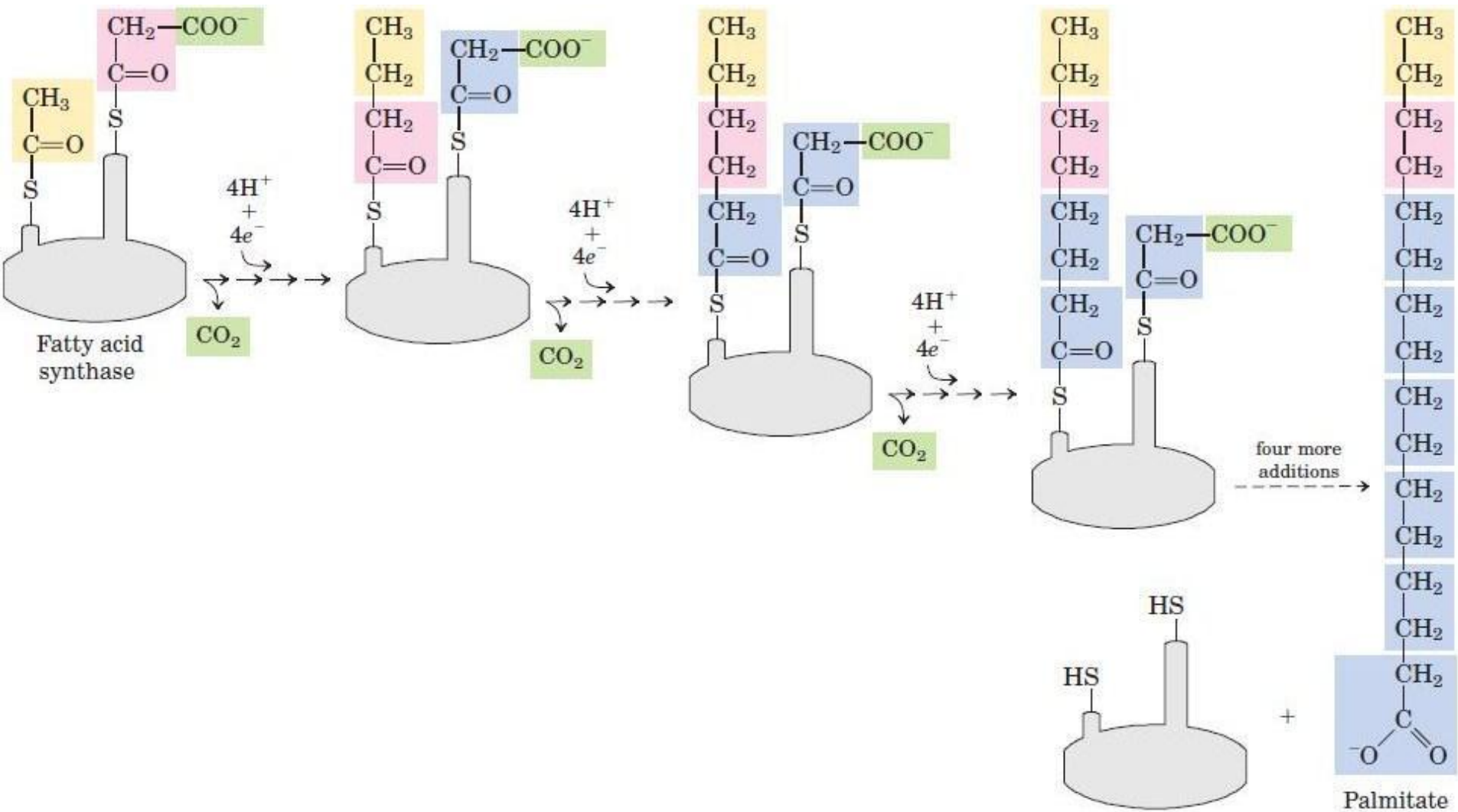

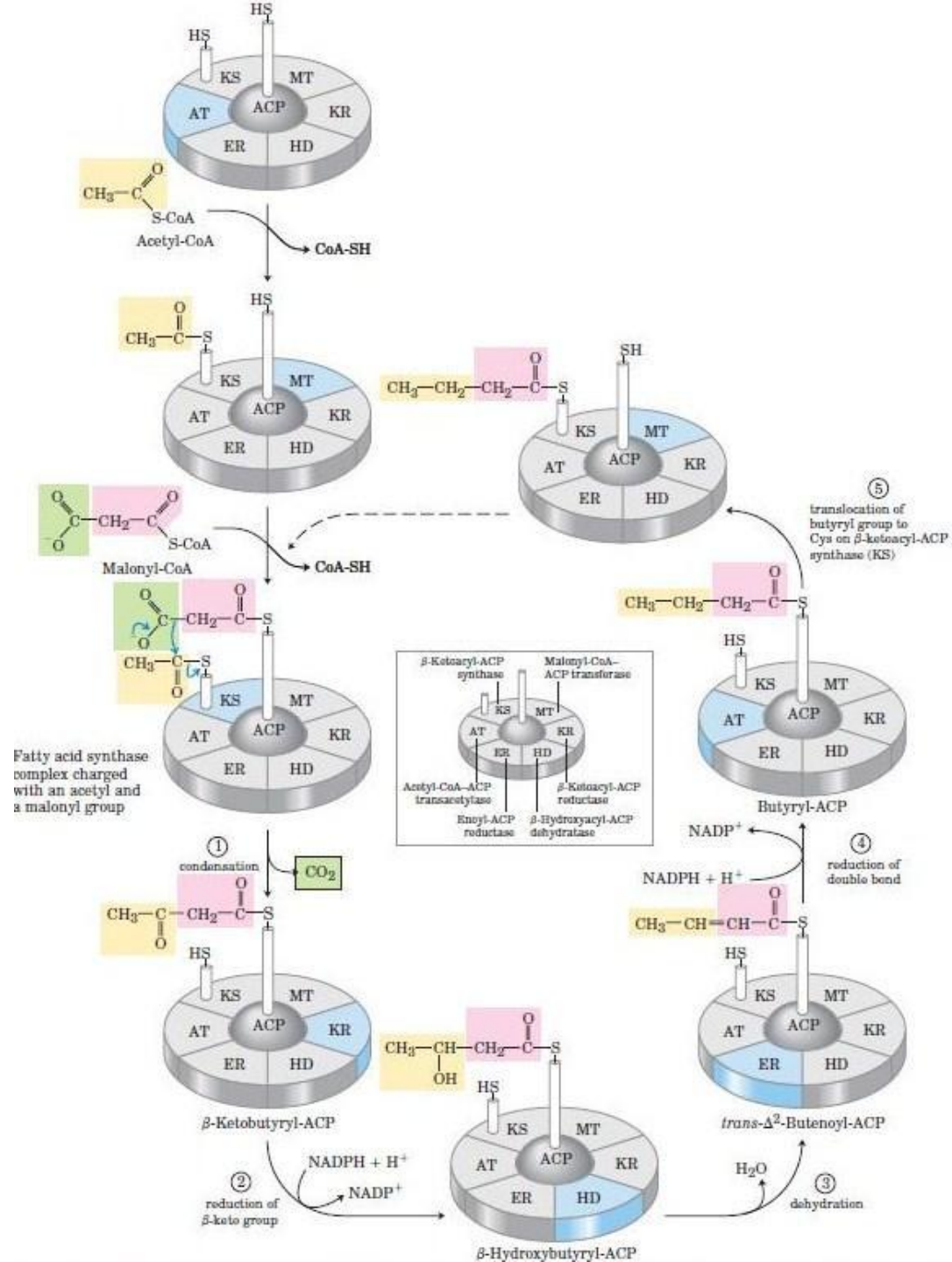

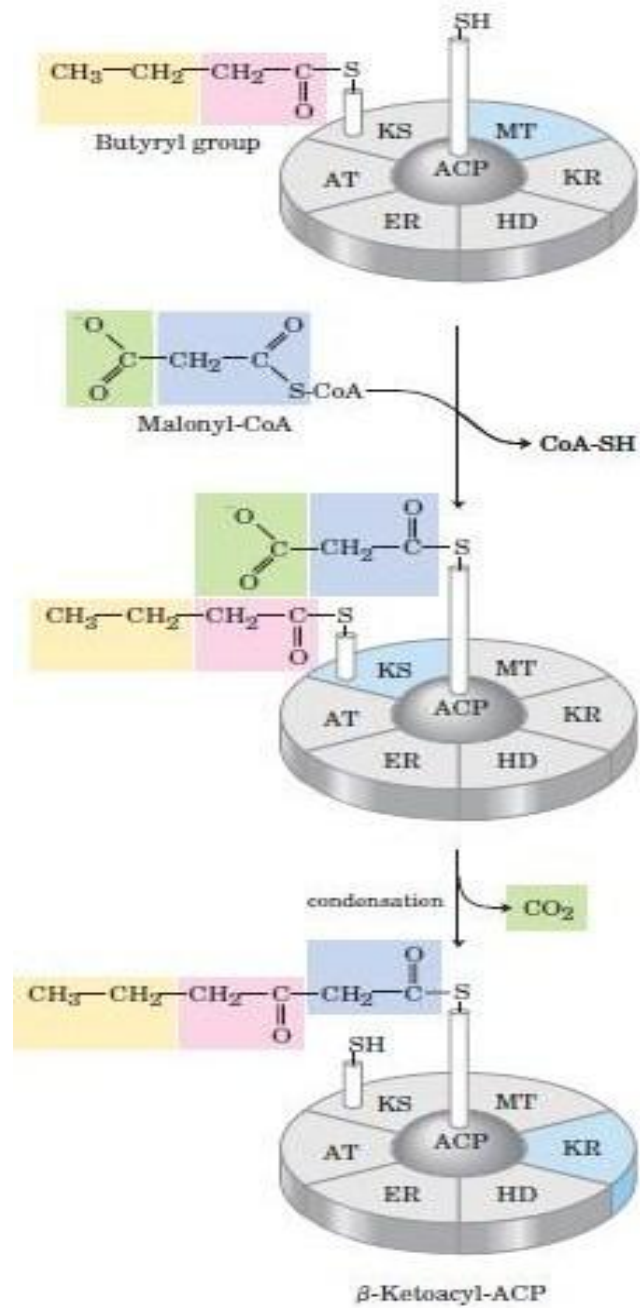

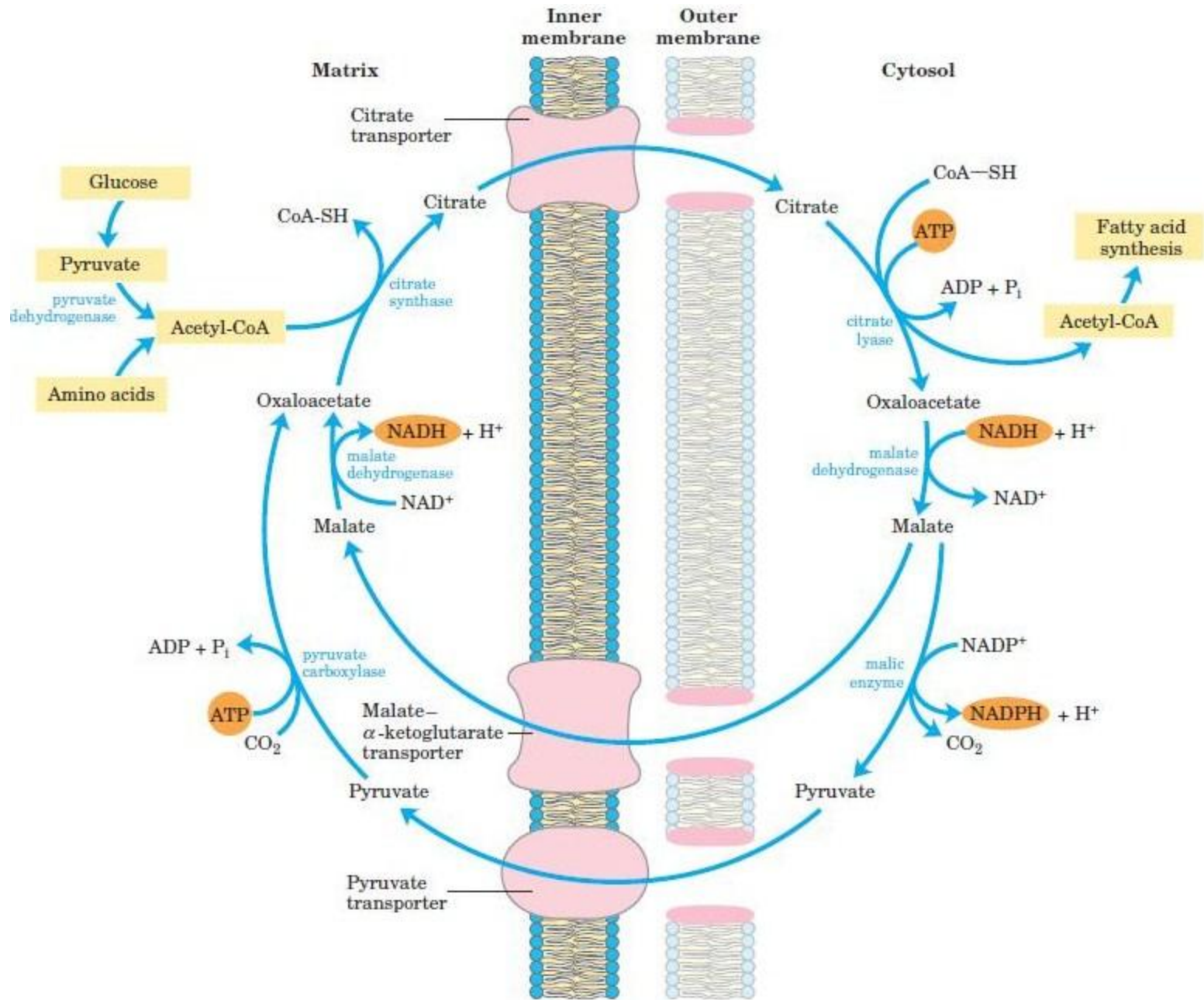

Згадаємо: пентозо-фосфатний цикл

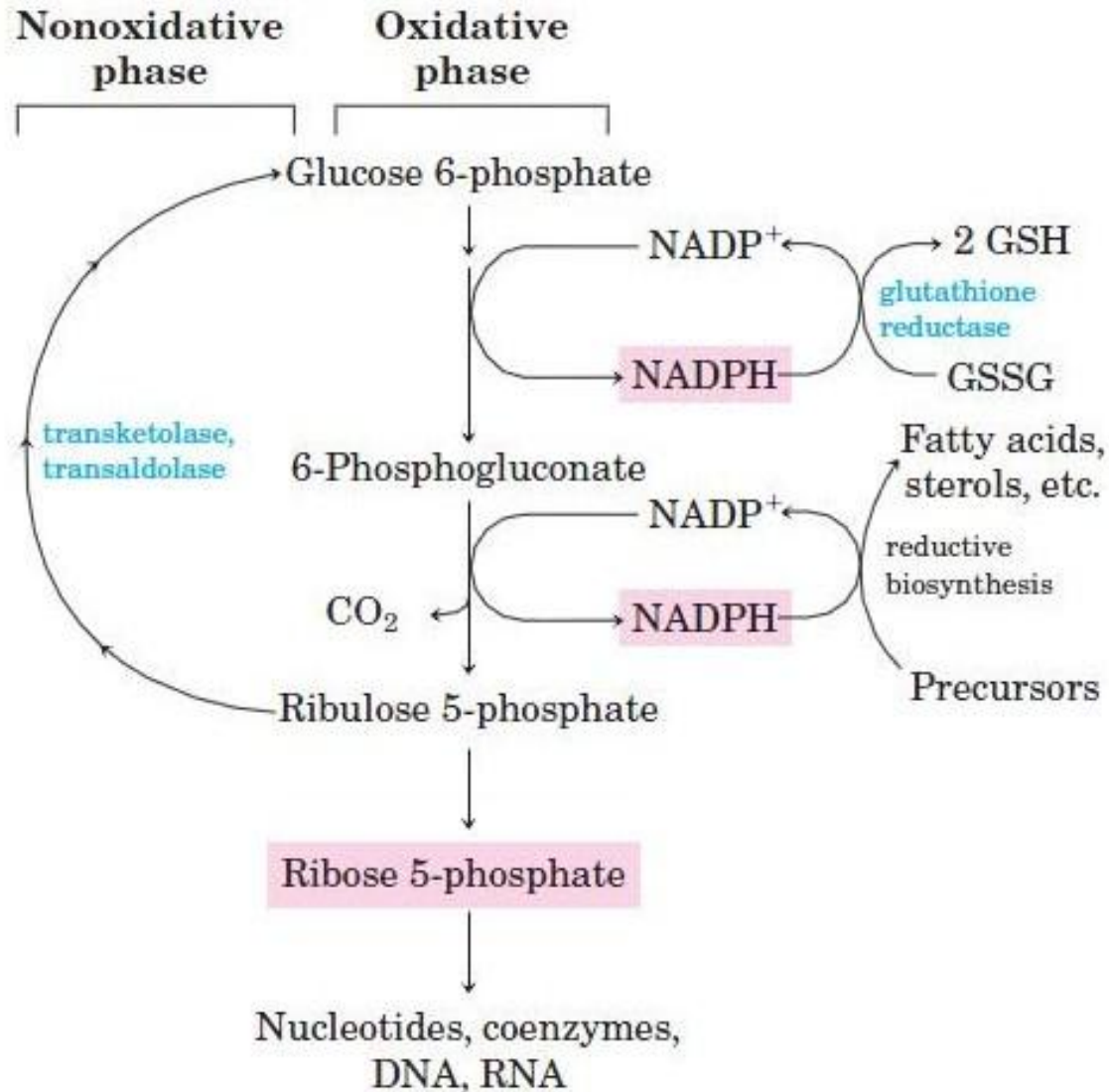

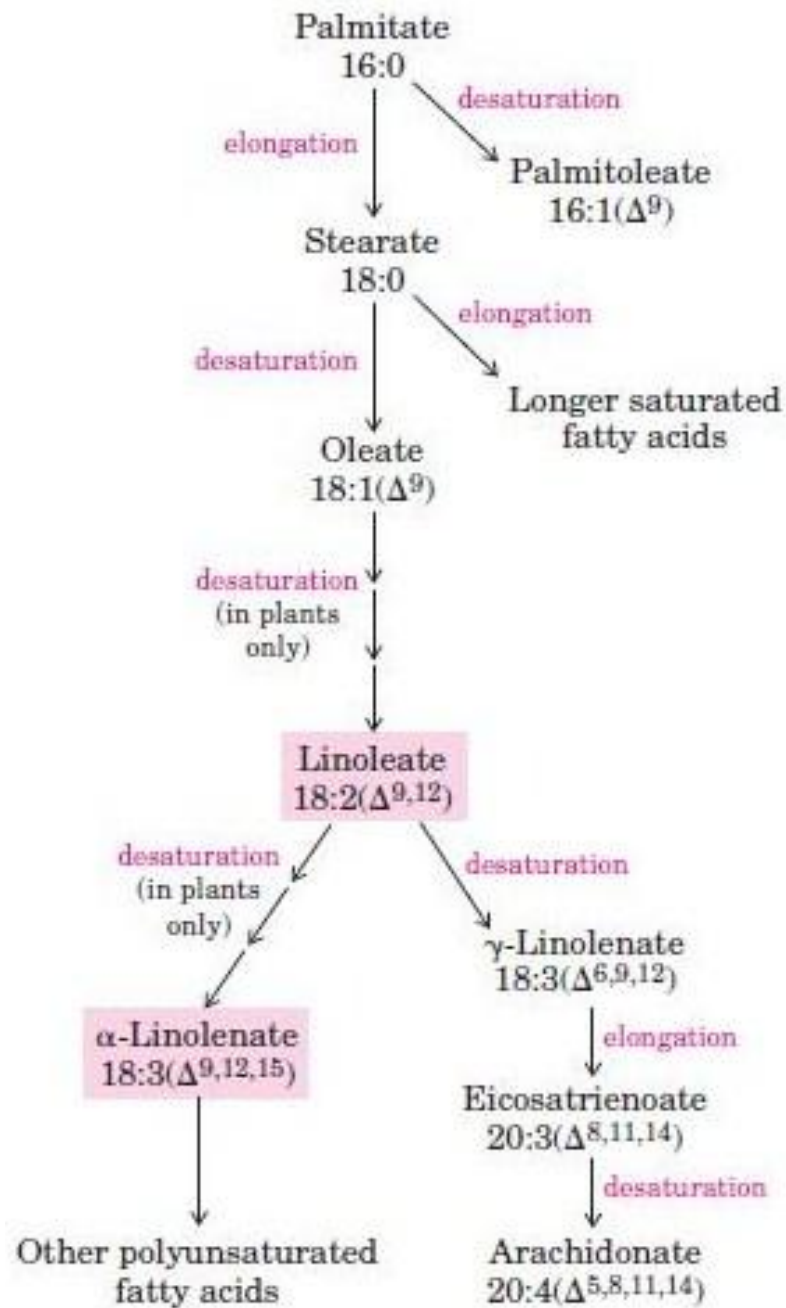

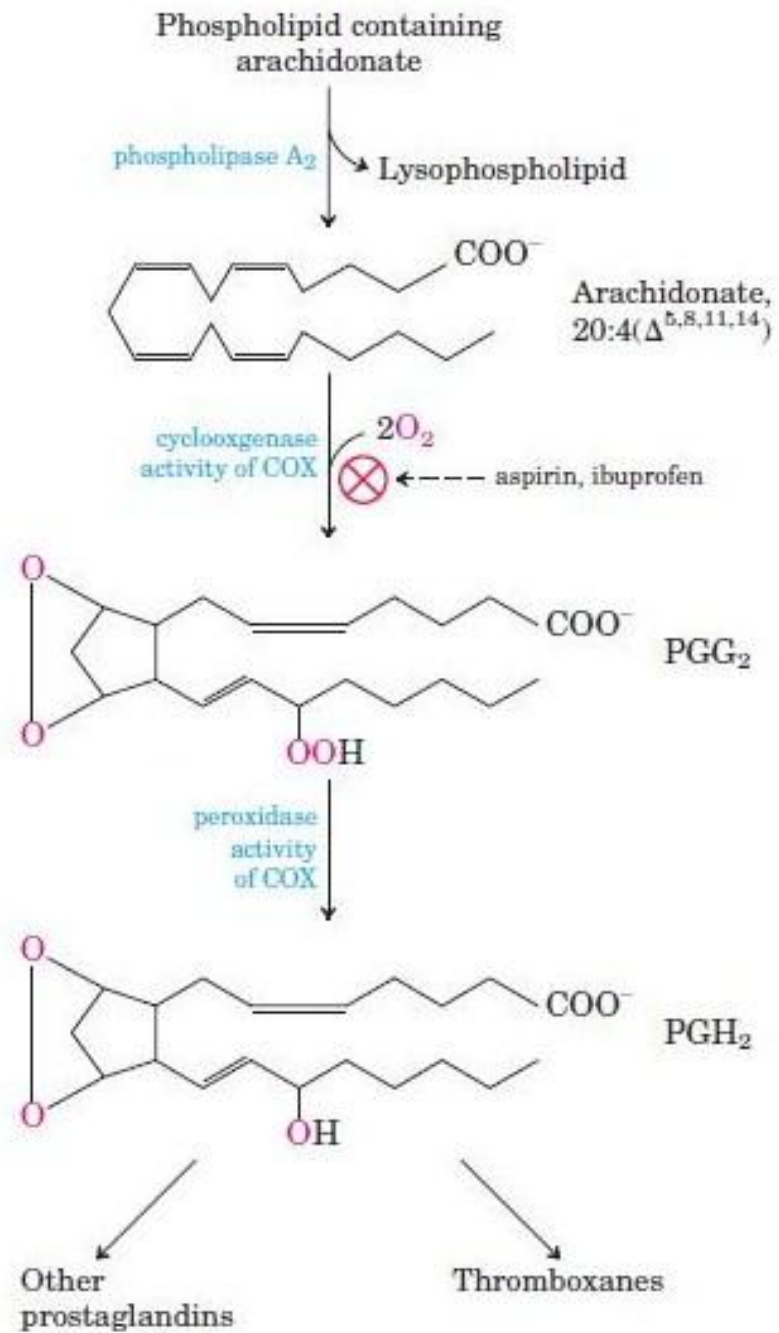

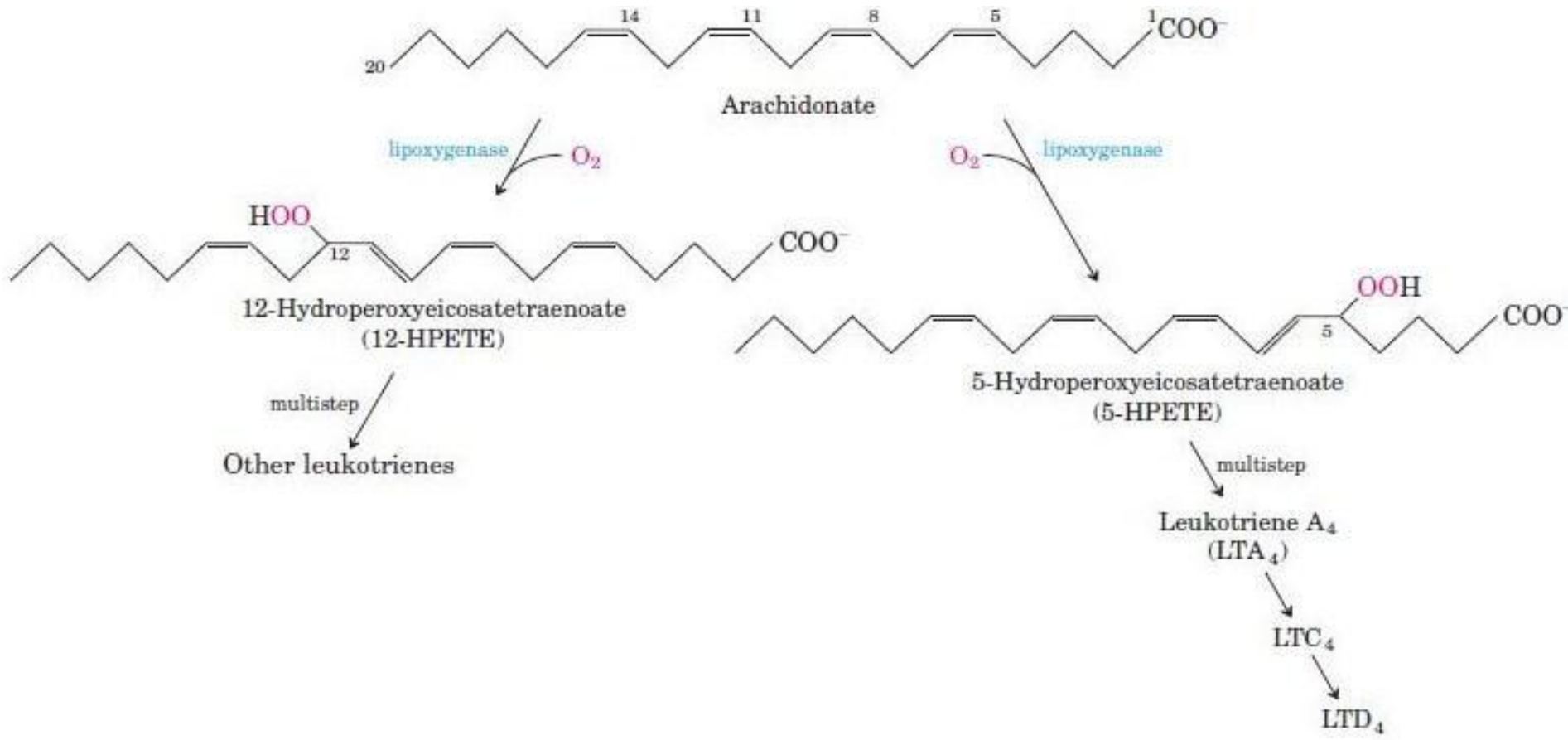

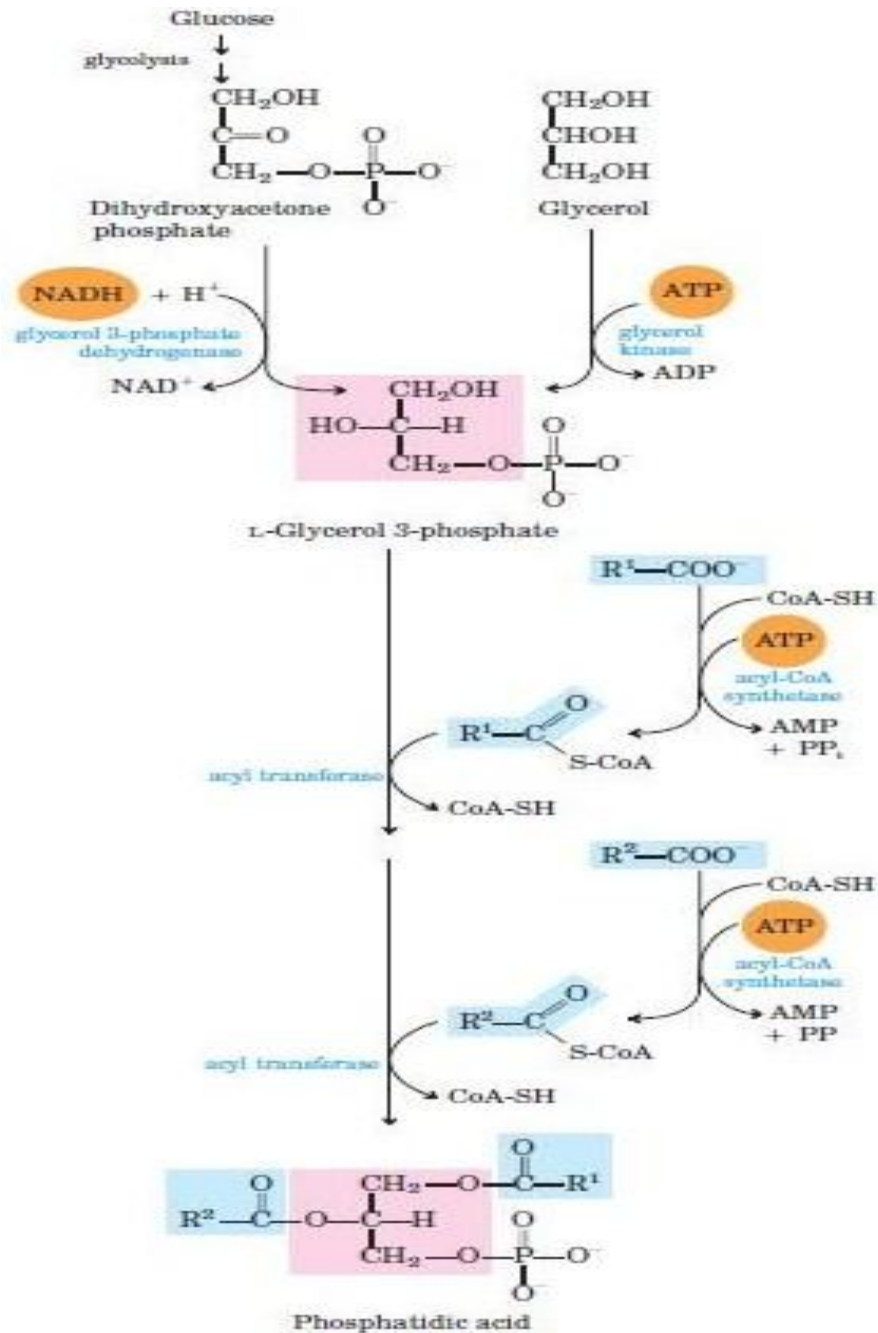

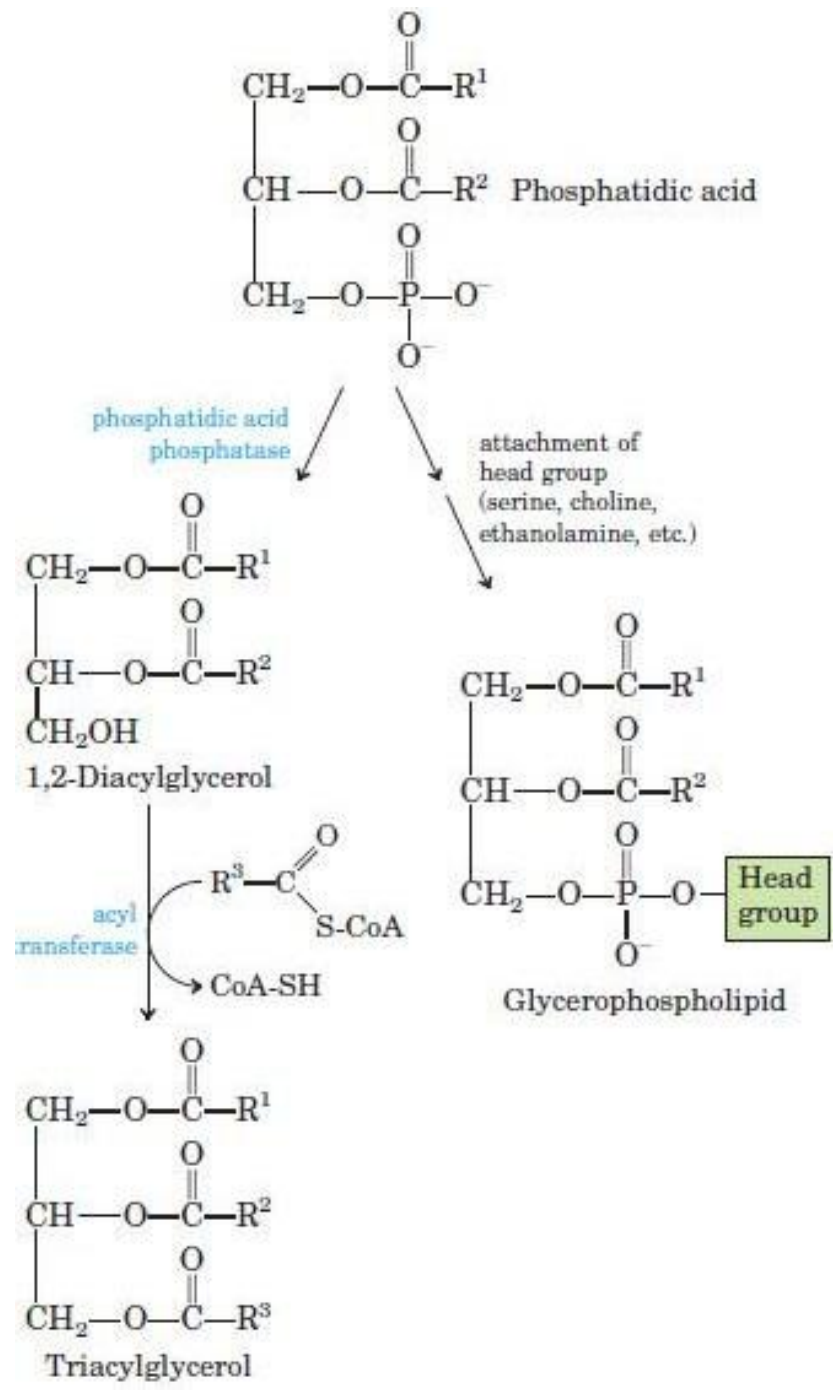

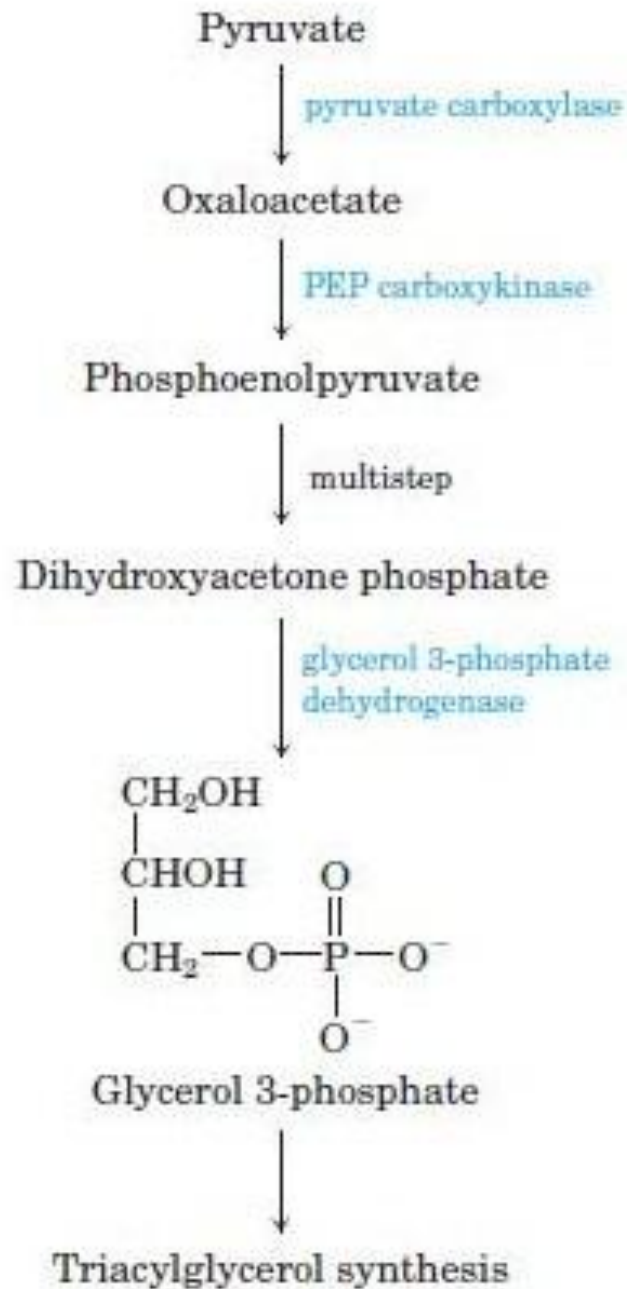

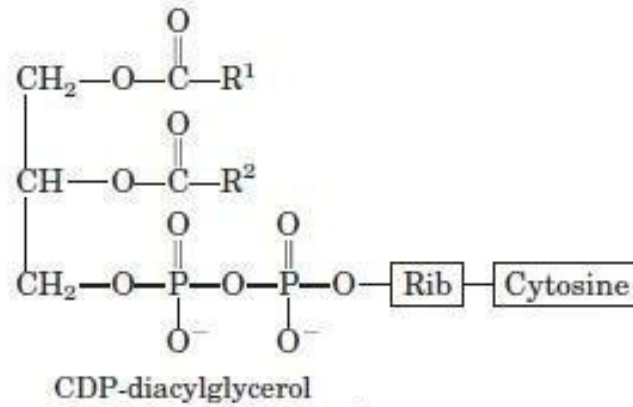

Phosphatidylglycerol
 cardiolipin synthase (eukaryotic)
 CMP

Inositol
 PI synthase
 CMP

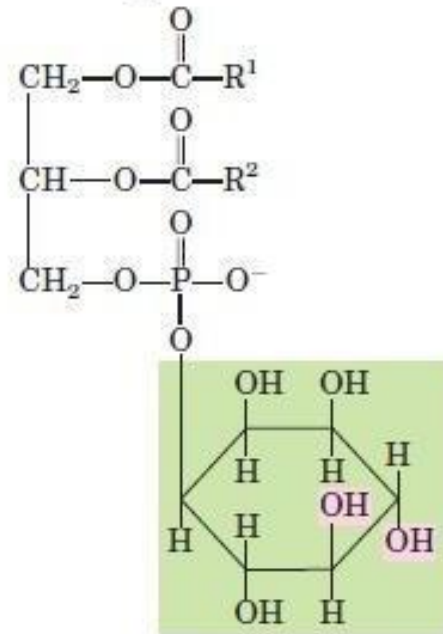
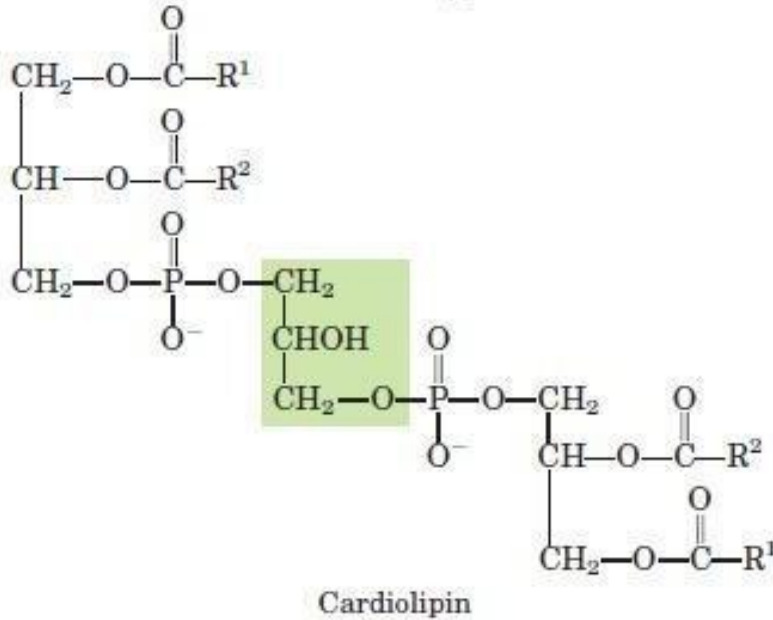

These —OH groups can also be esterified with —PO₃²⁻.

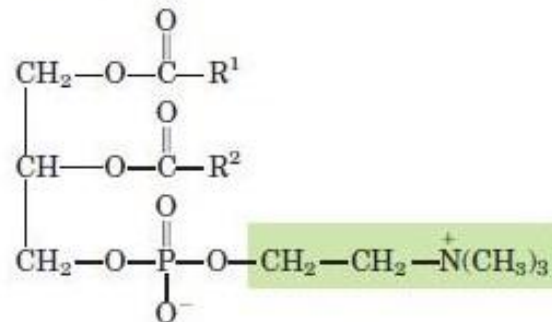
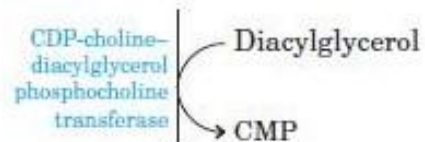
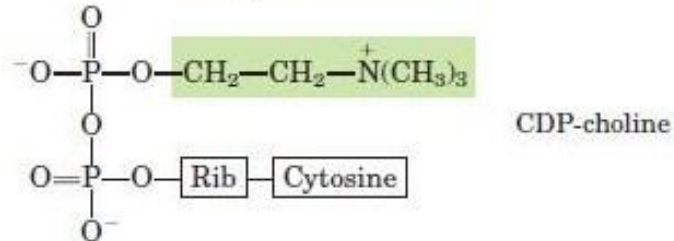
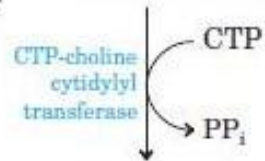
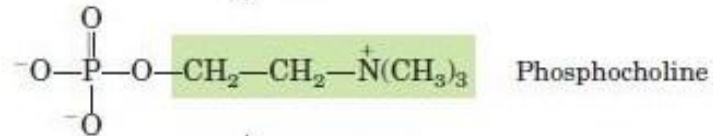
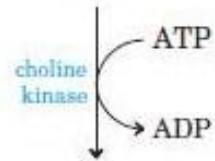
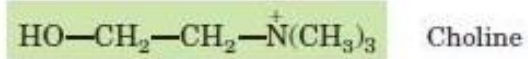

Phosphatidylcholine

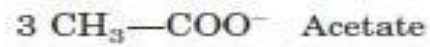

① ↓

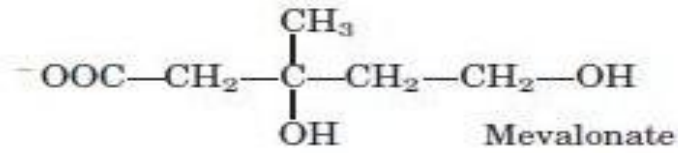

② ↓

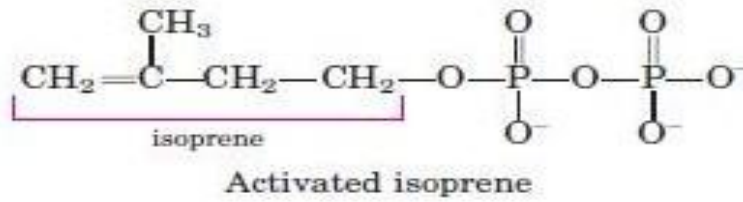

③ ↓

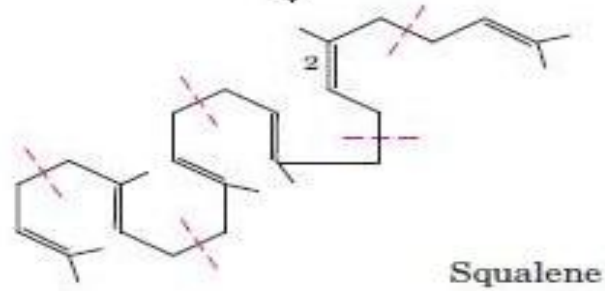

④ ↓

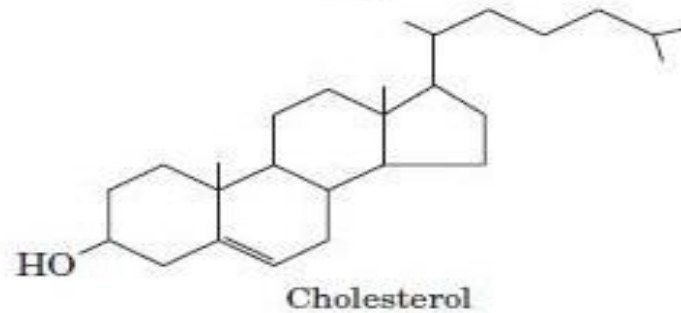

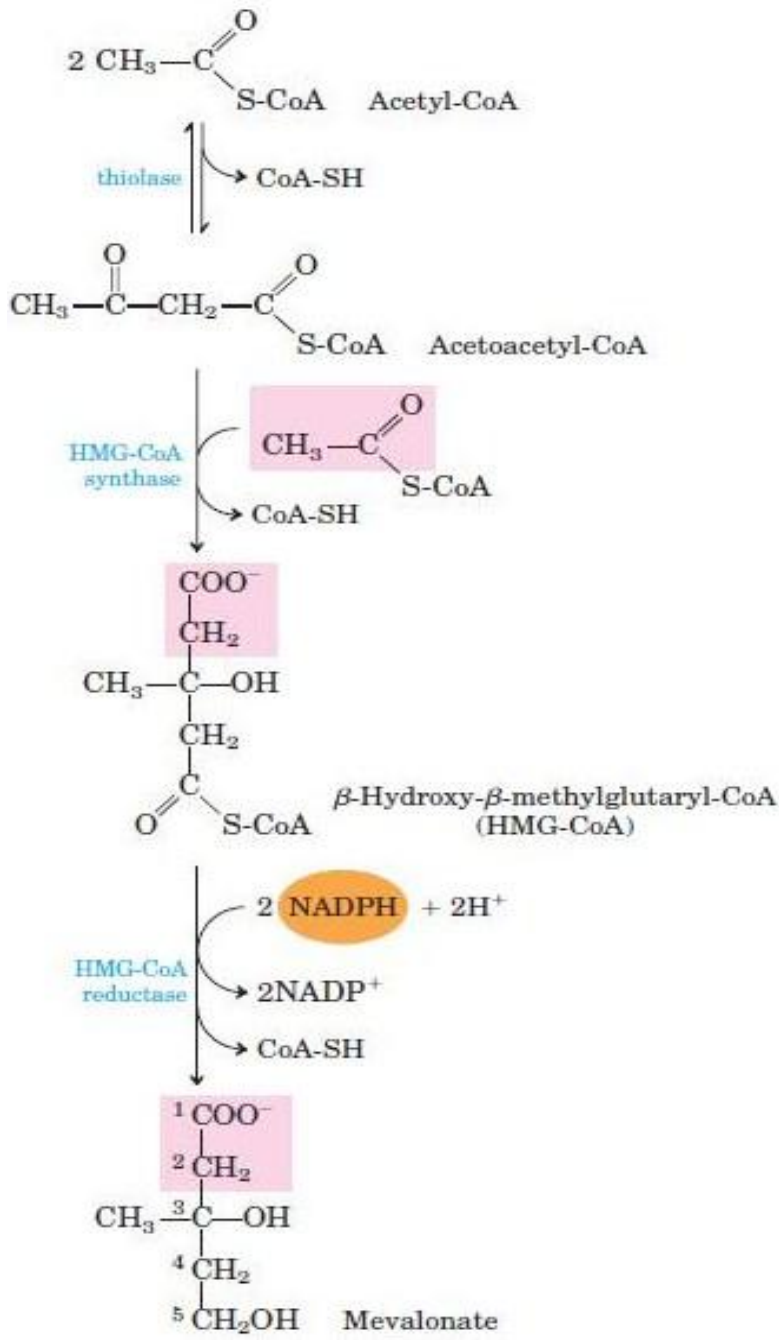

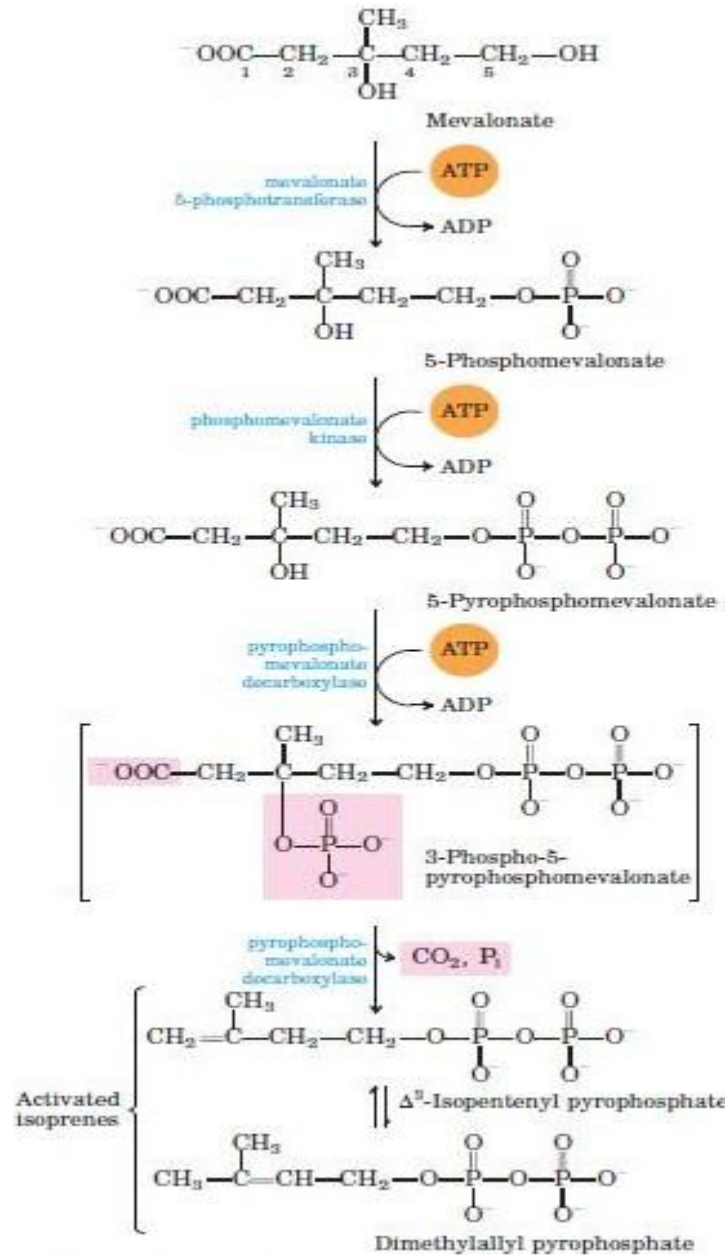

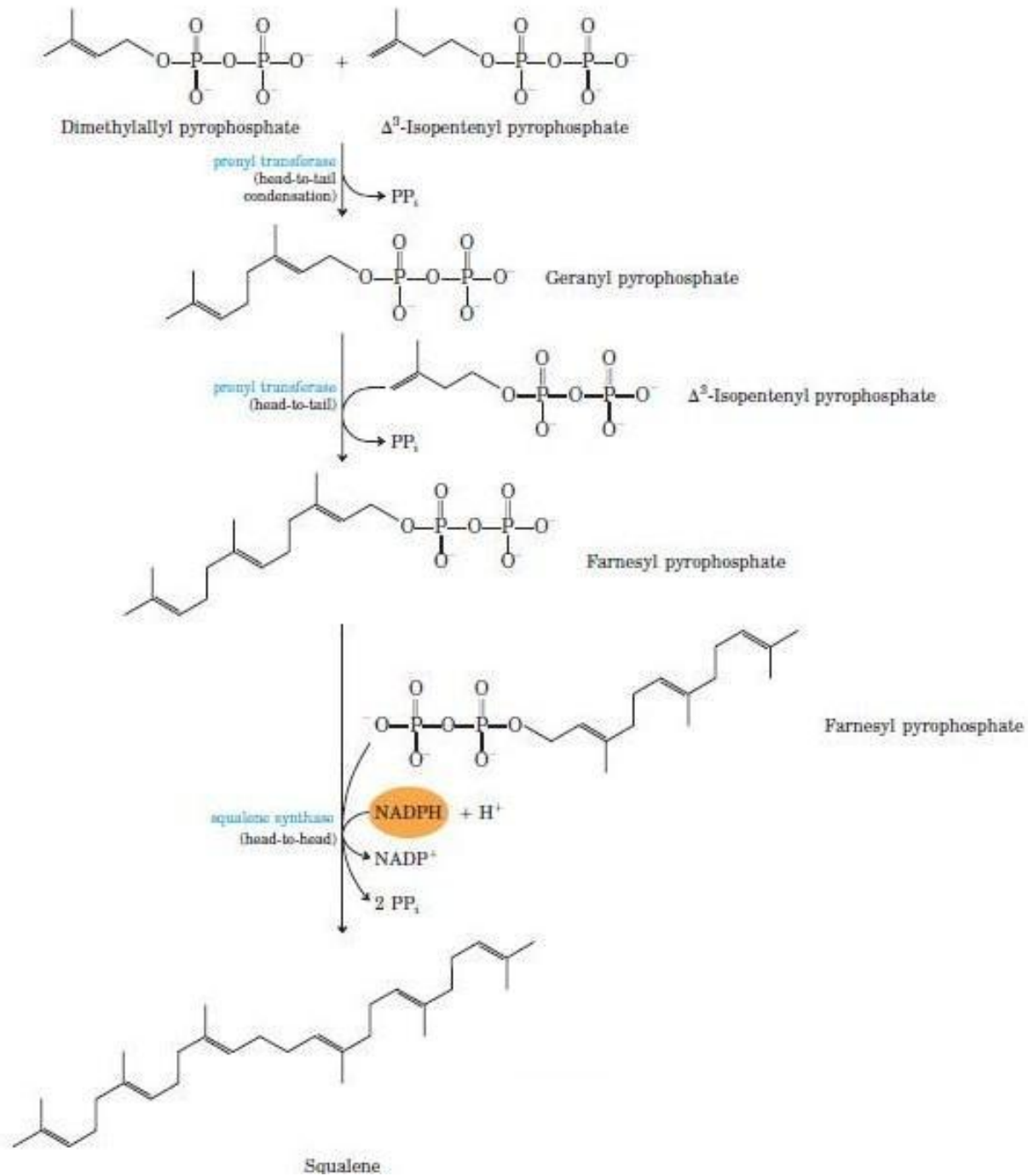

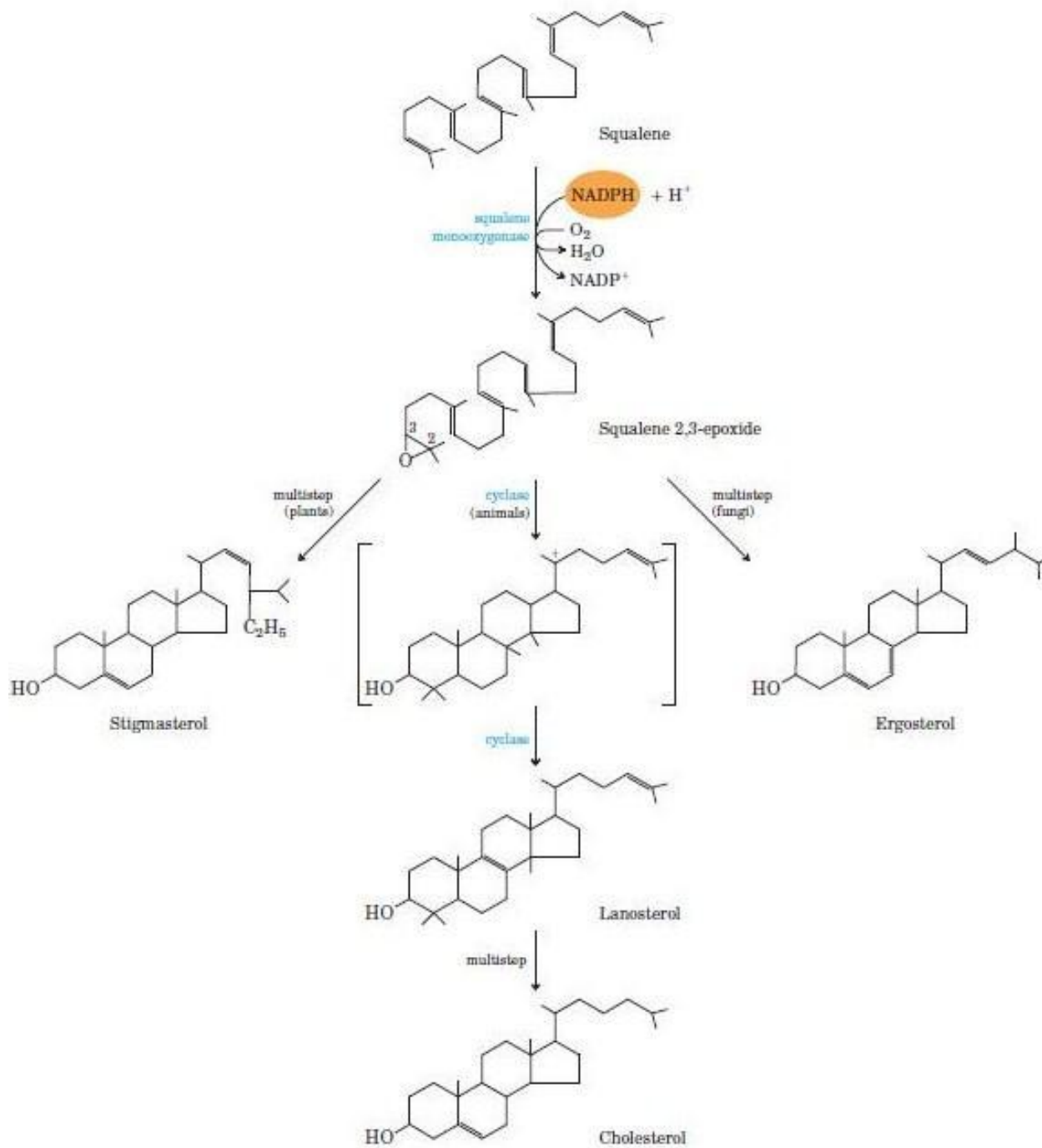

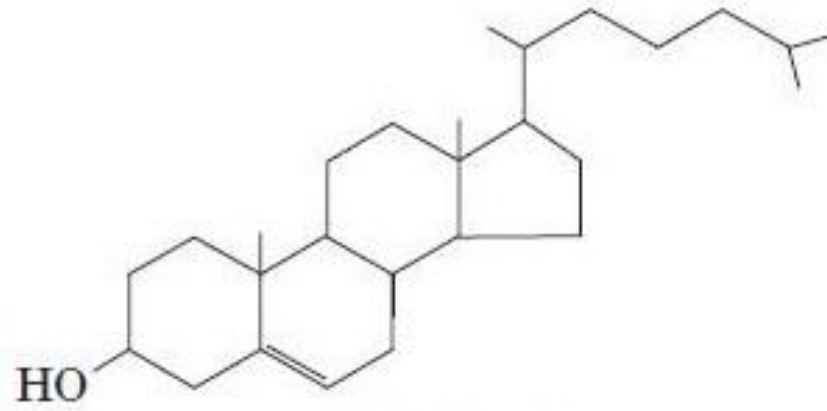

Cholesterol

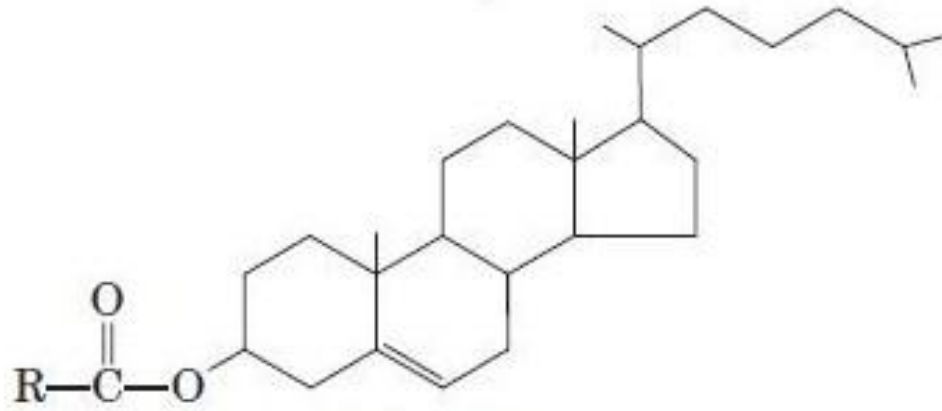
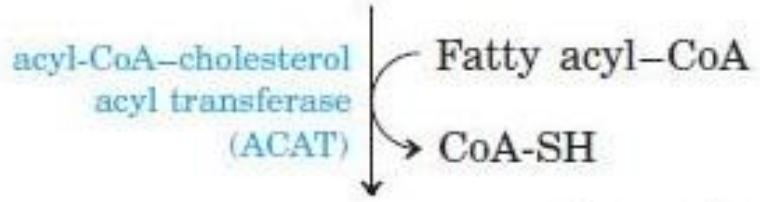

Cholesteryl ester

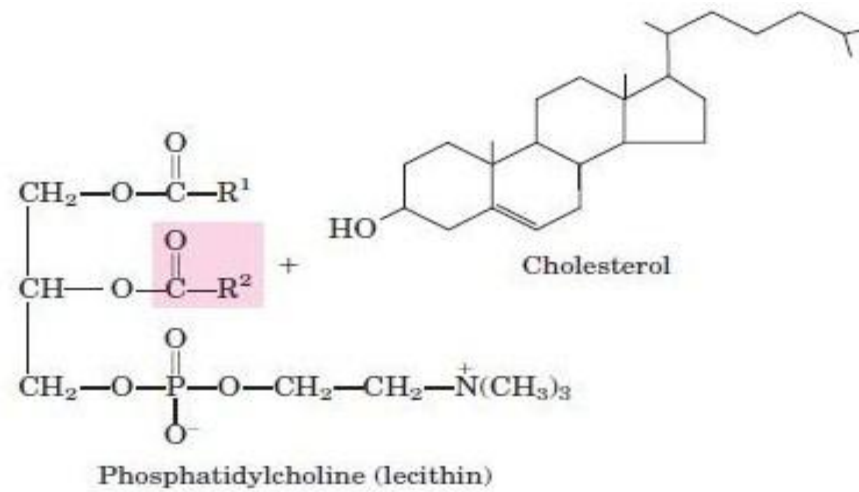

lecithin-cholesterol
acyl transferase
(LCAT)

