

Teoria Hibridizării Orbitalilor Atomici

Hibridizare sp^2

Hibridizare sp

Hibridizare sp^3

Hibridizare d^3s

Hibridizare sp^3d

Hibridizare sp^3d^2

Hibridizare sp^3d^3

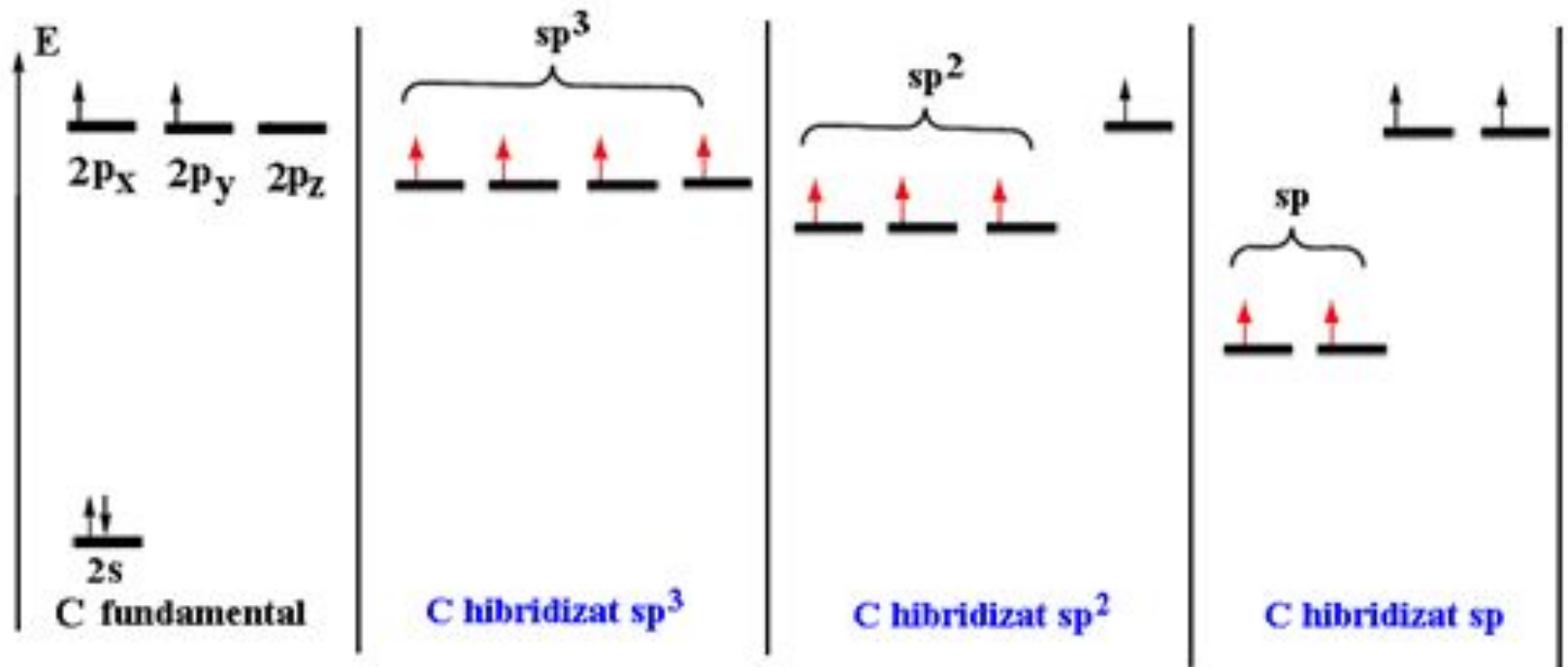

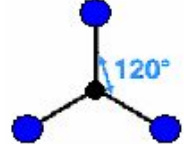
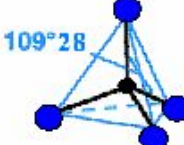
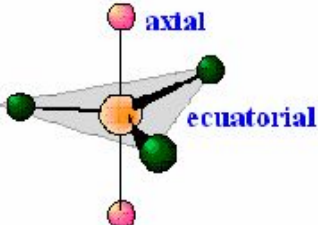
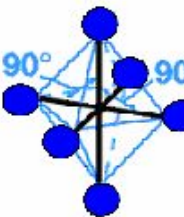
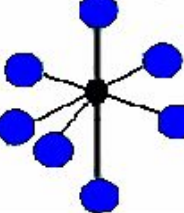

Fig. 3.16. Hibridizarea atomului de carbon.

Număr de coordinare	Hibridizare	Geometrie
2	sp	Liniară
3	sp²	Trigonală
4	sp³	Tetraedrică
4	dsp²	Plan-pătratică
5	dsp³, d³sp	Bipiramidal-trigonală
5	d²sp², d⁴s	Piramidă pătratică
6	d²sp³, sp³d²	Octaedrică
7	d³sp³, sp³d³	Bipiramidal-pentagonală

Tabel 3.2. Principalele tipuri de hibridizare și geometriile corespunzătoare.

Hibridizare	Geometrie	Exemple
sp	<p>Linara (unghiulara)</p>  <p>180°</p>	<p>$BeCl_2$ CO_2 C_2H_2 HCN, O_2</p>
sp^2	<p>Triunghiulara</p>  <p>120°</p>	<p>$BF_3, AlBr_3$ BCl_3 NO_3^- CO_3^{2-} SO_2 C_2H_4 O_3</p>
sp^3	<p>Tetraedrica</p>  <p>109°28'</p>	<p>CH_4, CCl_4, NH_4^+ $PO_4^{3-}, SO_4^{2-}, ClO_4^{-1}$ NH_3, H_3O^+, PCl_3 H_2O, F_2O C_2H_6</p>
$sp^3 d$	<p>Bipiramida triunghiulara</p>  <p>axial ecuatorial</p>	<p>PCl_5 PF_5 $Fe(CO)_5$ SCl_4 SF_4 ICl_3 XeF_2 ClF_3</p>
$sp^3 d^2$	<p>Octaedrica</p>  <p>90° 90°</p>	<p>SF_6 XeF_4 ICl_4^- $XeOF_4$ $[AlF_6]^{-1}$ $[PF_6]^{-1}$ ClF_5</p>
$sp^3 d^3$	<p>Bipiramida pentagonala</p> 	<p>IF_7 XeF_6</p>

Hibridizare sp

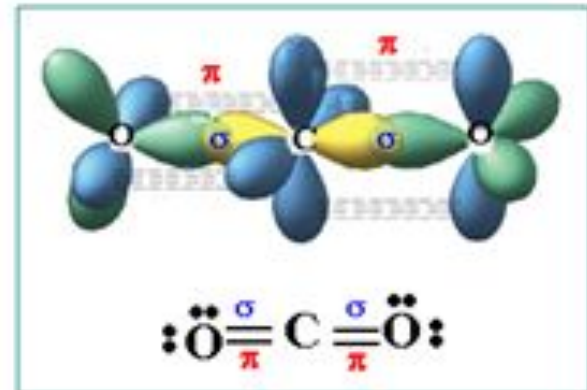
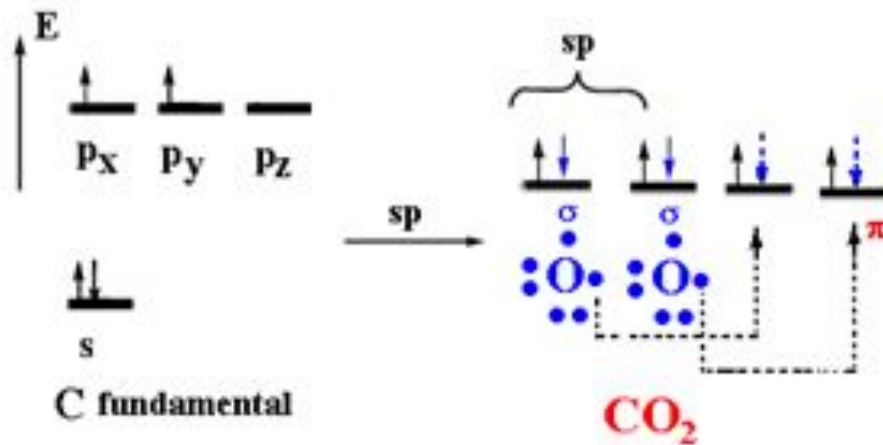
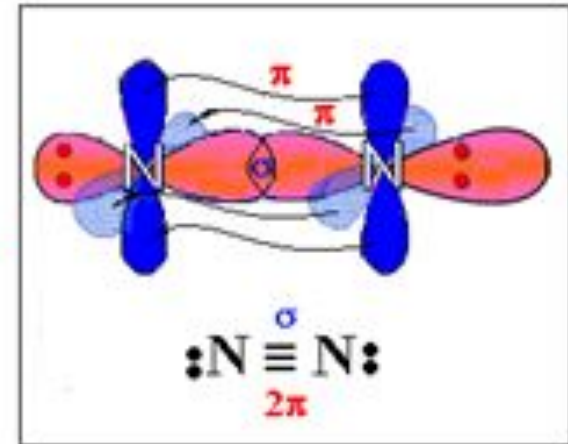
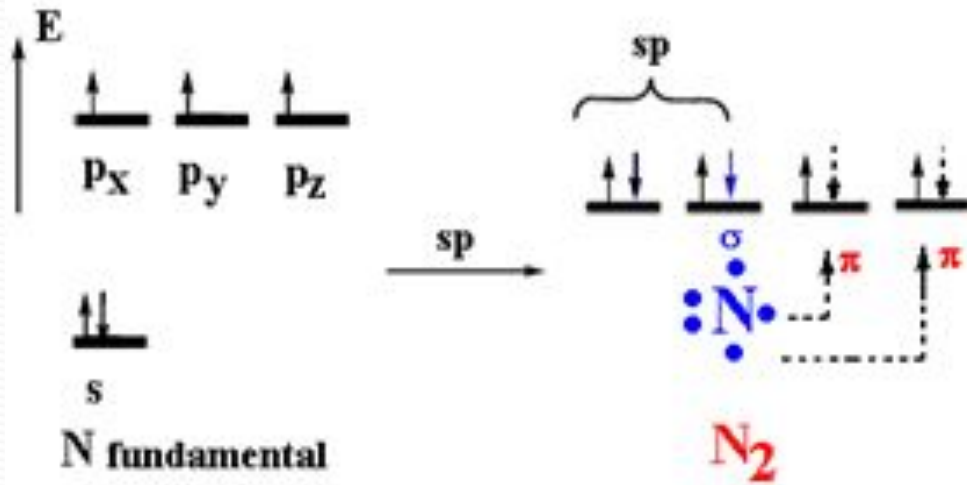

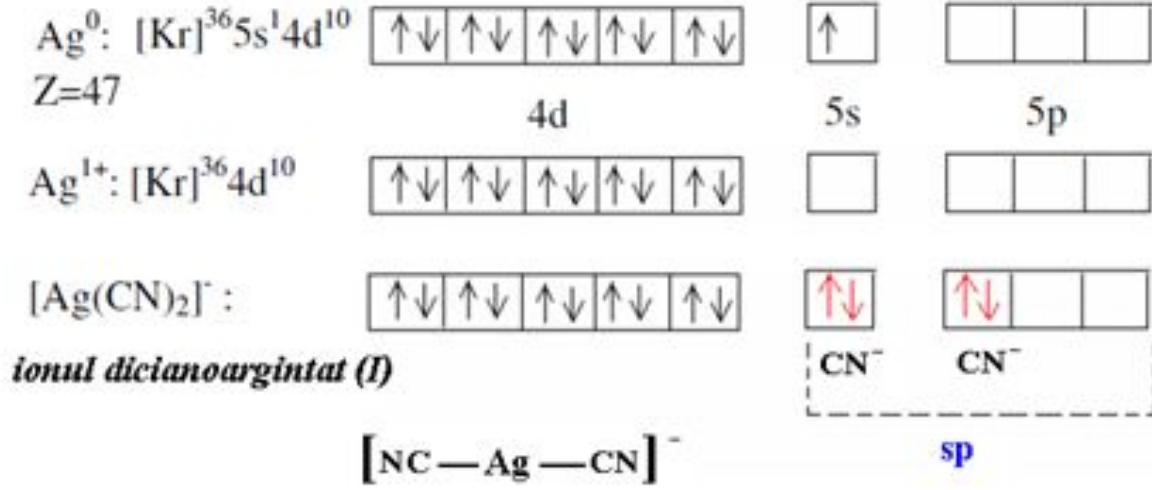

2. Hibridizare sp^2

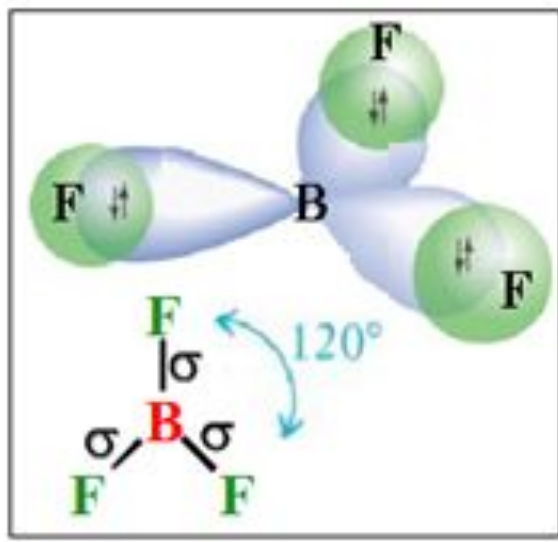
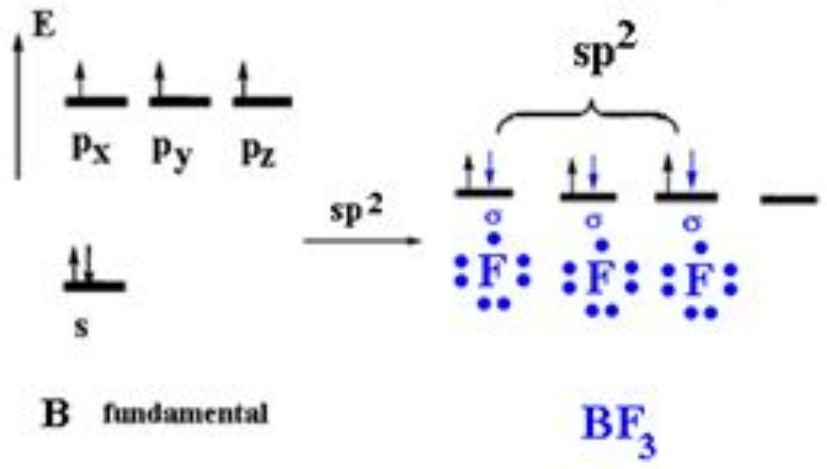

3. Hibridizare sp^3

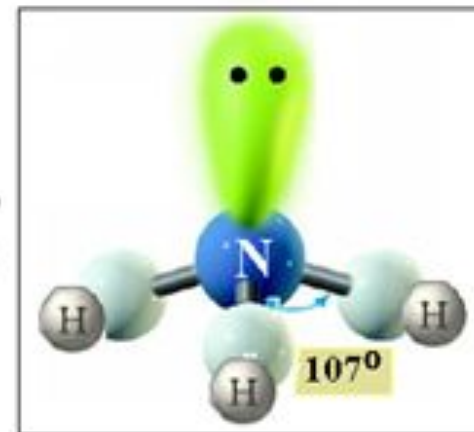
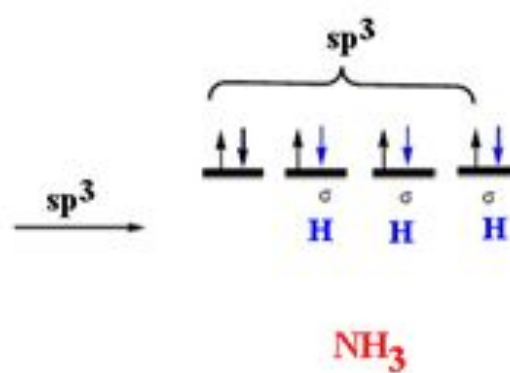
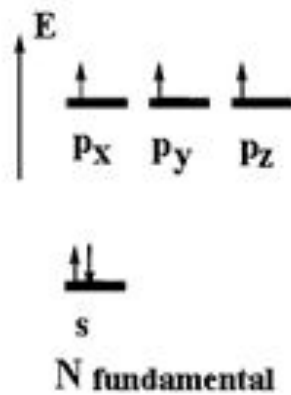
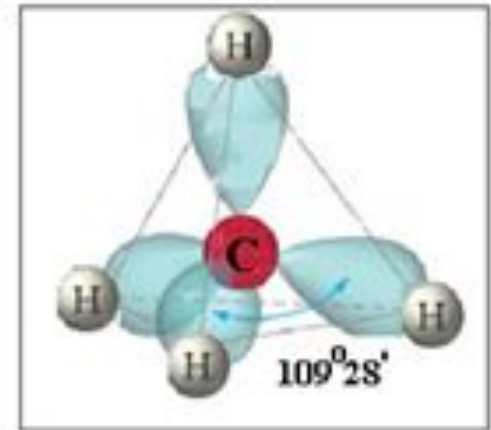
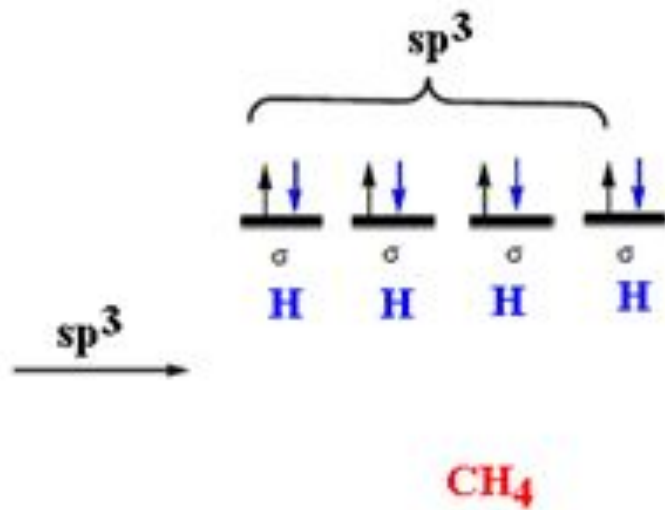
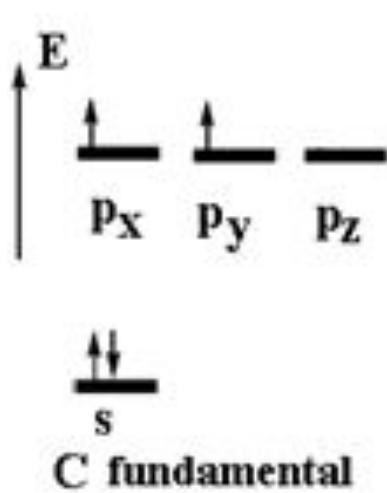

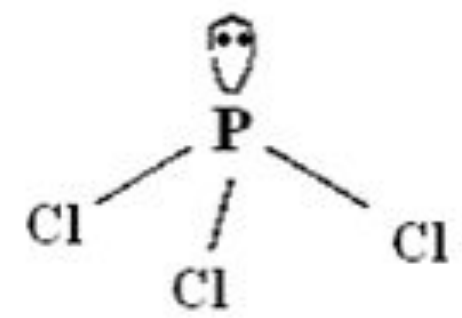
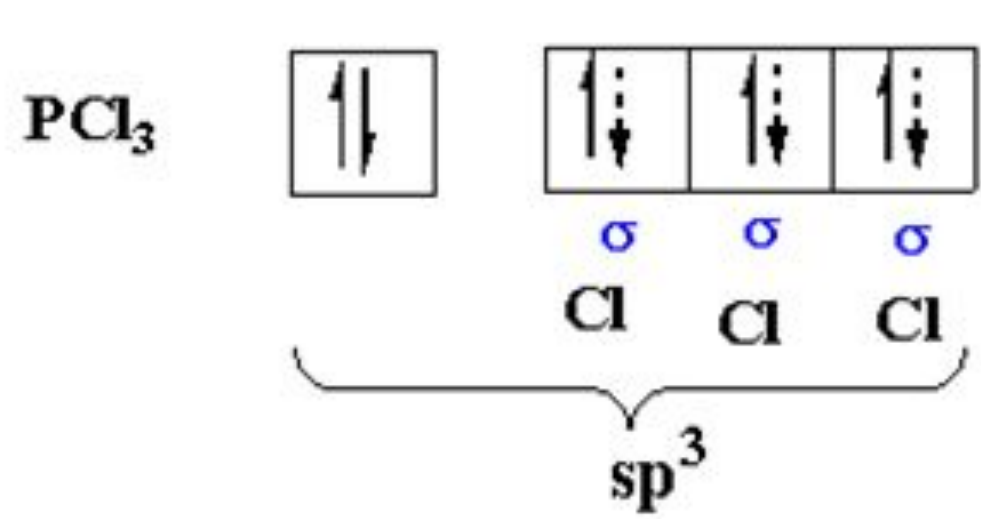
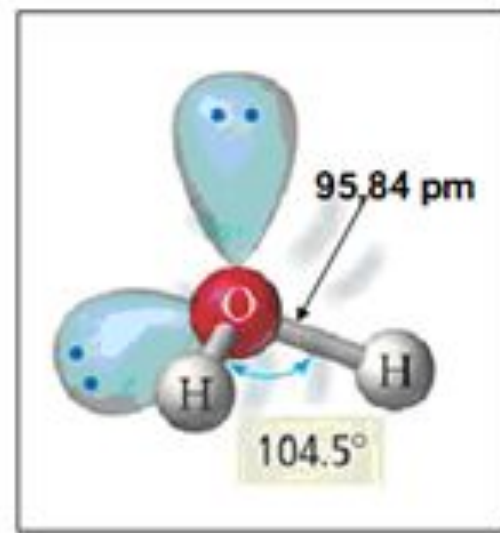
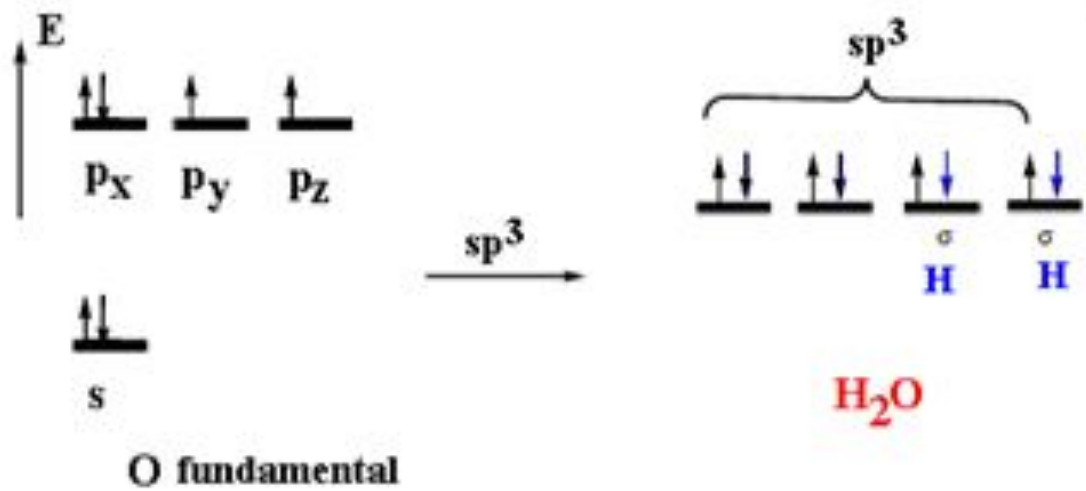

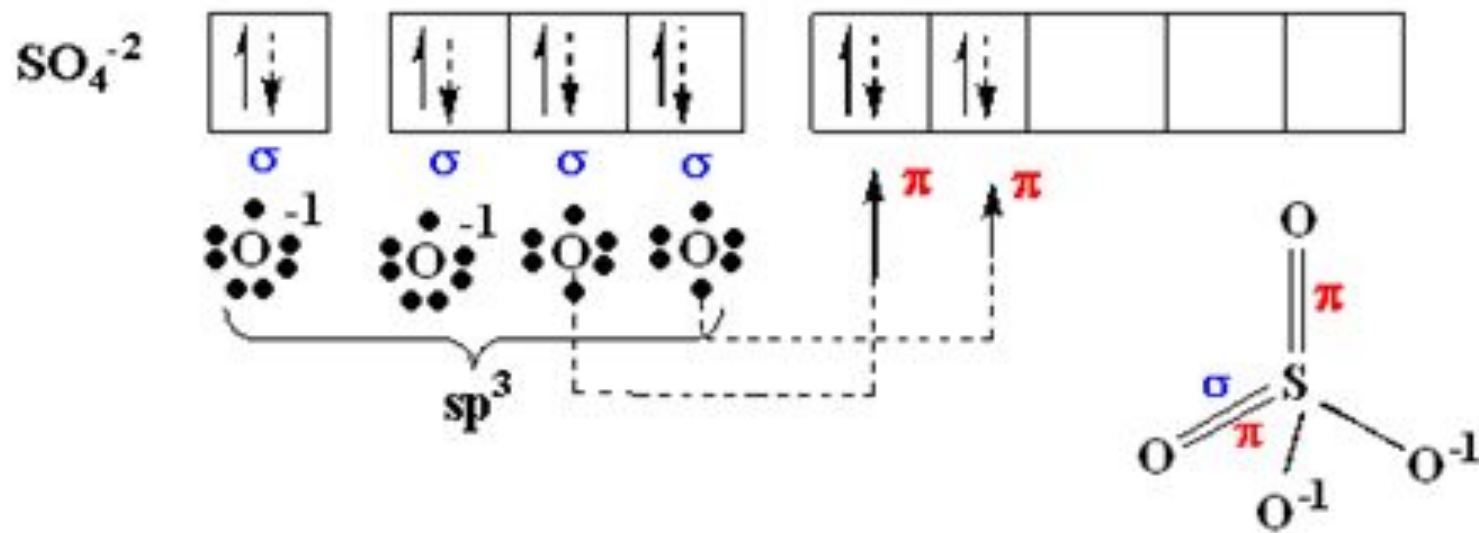
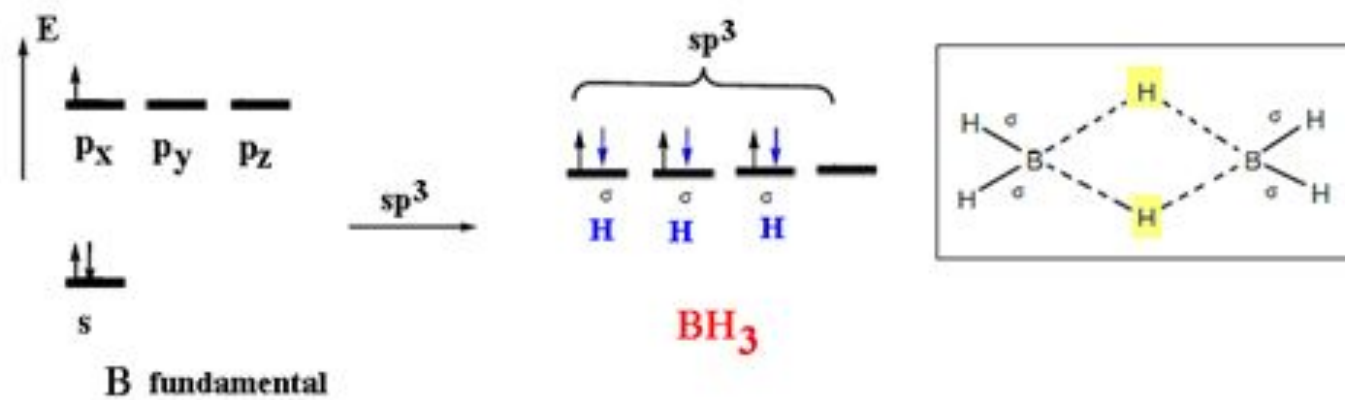

Aplicație: Determinați geometria și hibridizarea în: ClO_4^{-1} , PO_4^{-3} .

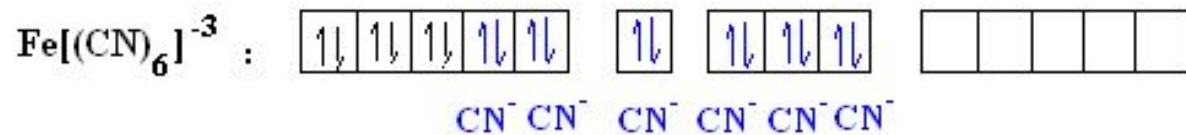
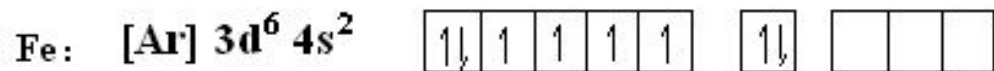

d²sp³

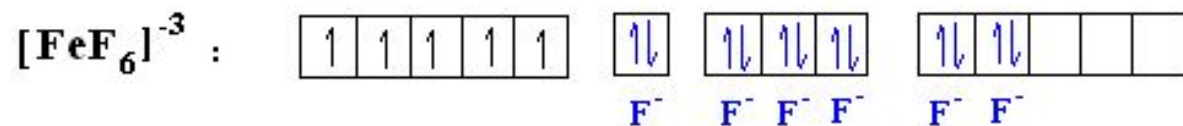

sp³d²

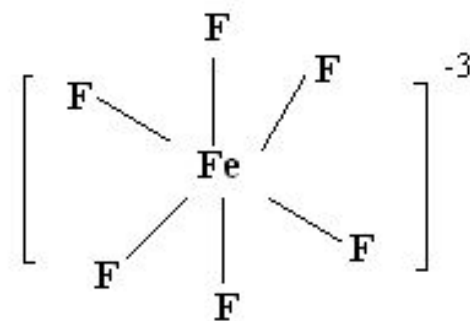
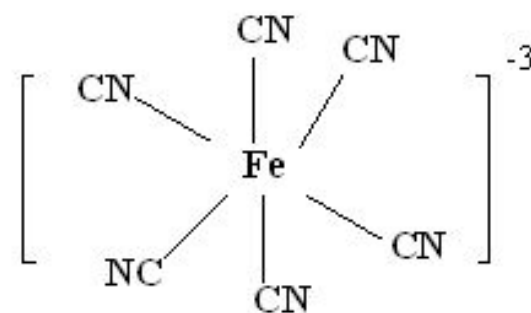

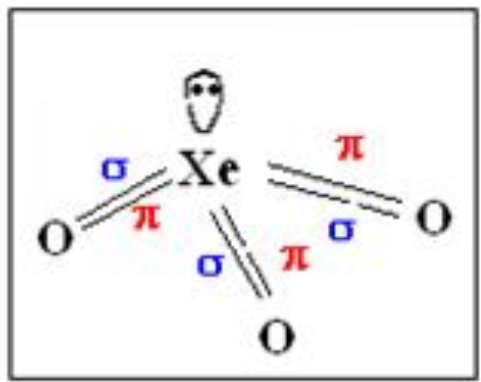
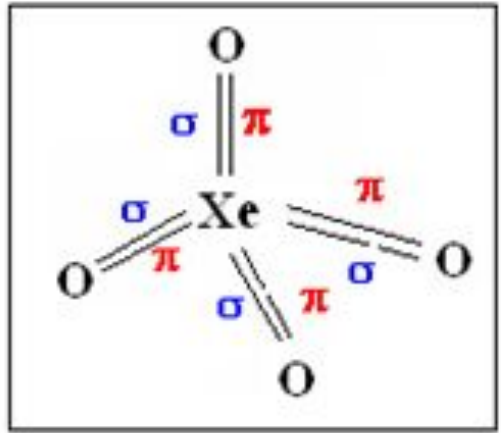
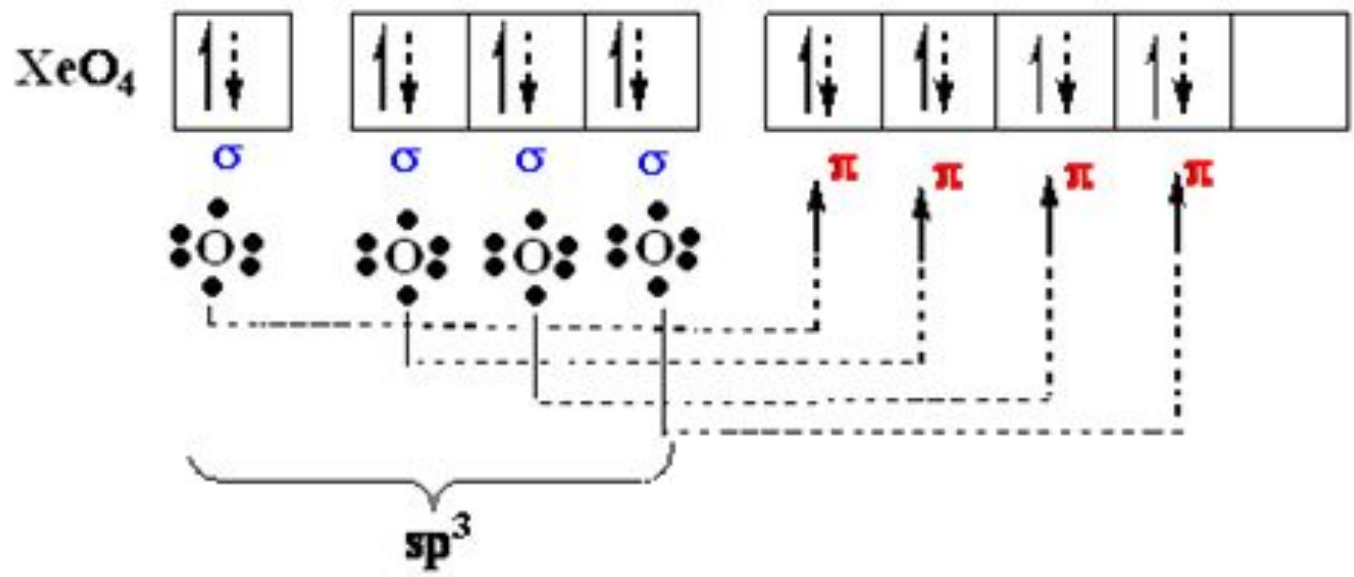

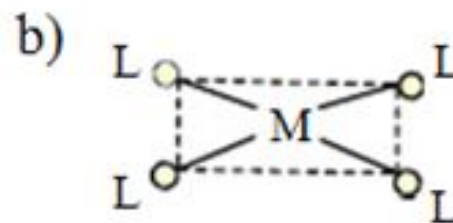
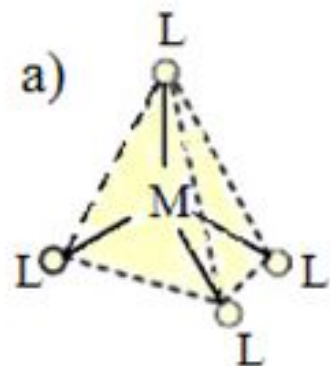

Geometrii caracteristice N.C.=4
a) tetraedru; b) geometrie plan-pătrată

|

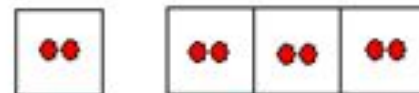
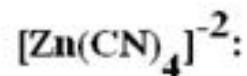
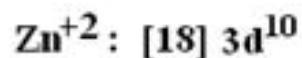
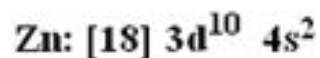

sp³

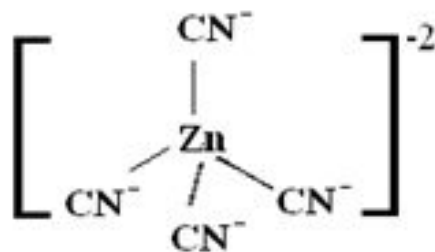

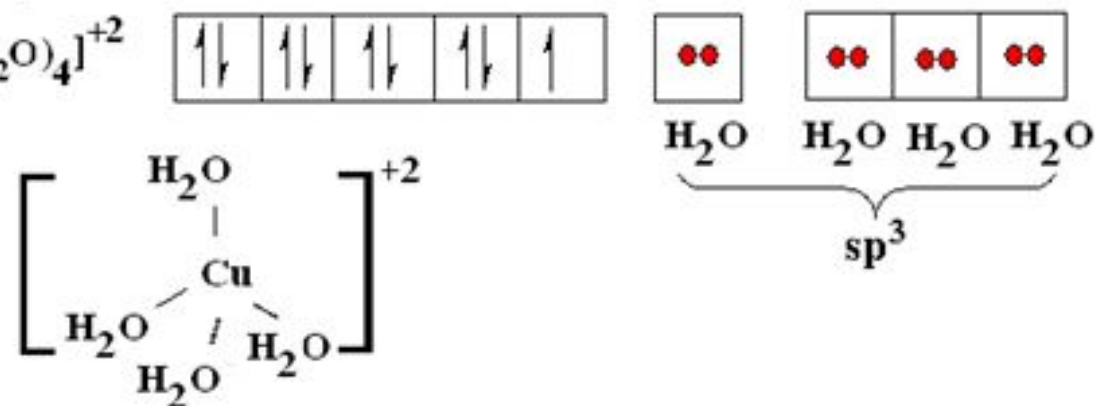
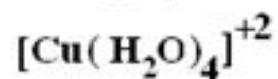
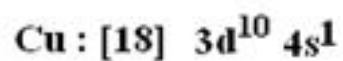
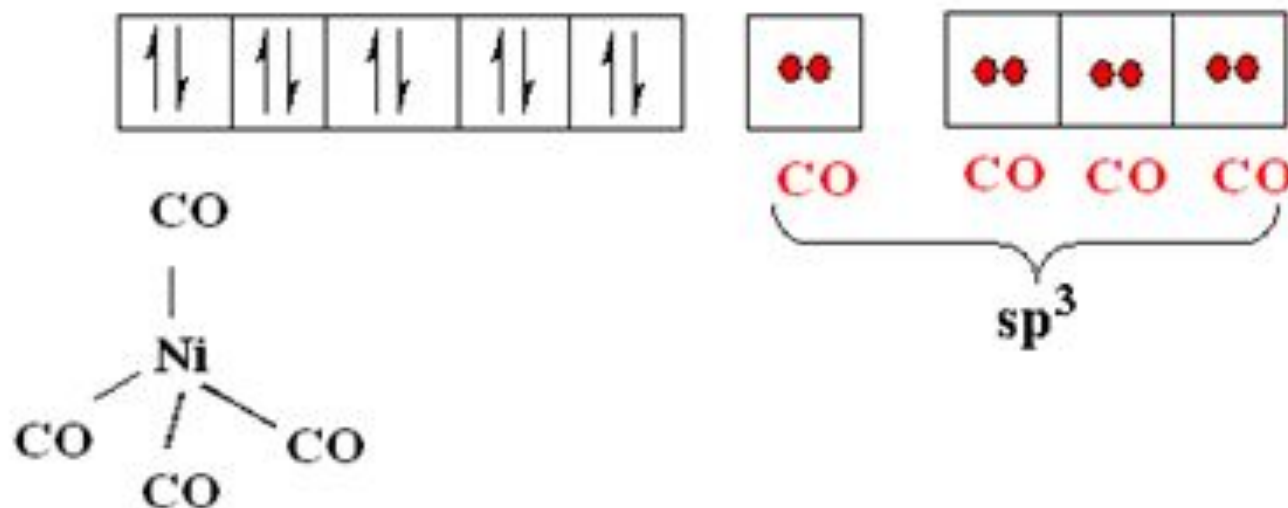
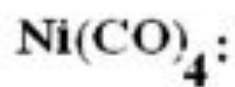
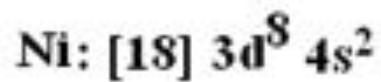

Hibridizare d^3s

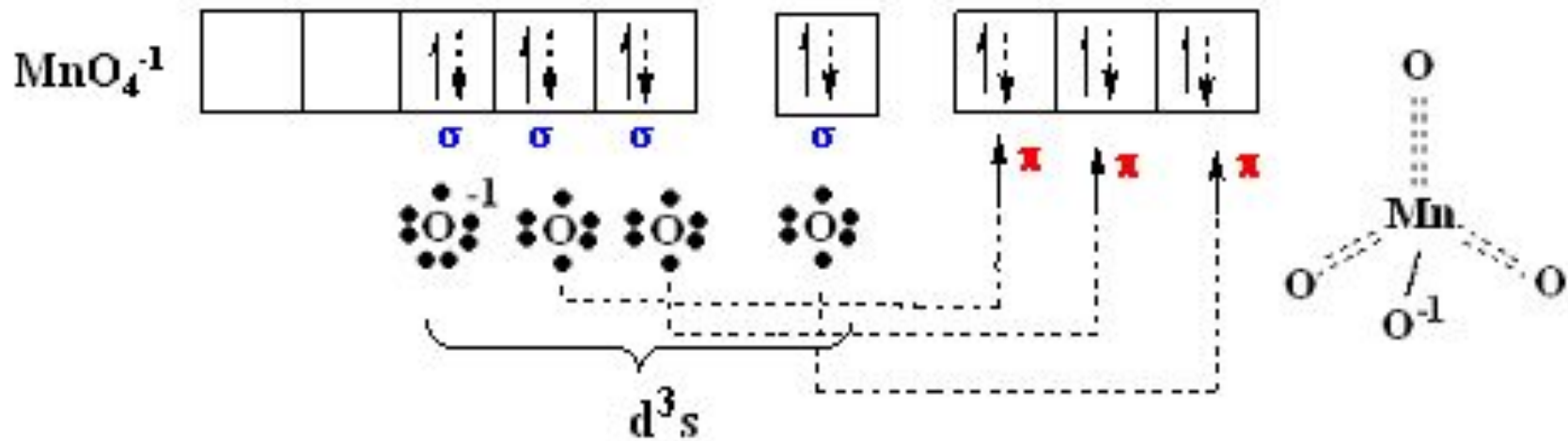
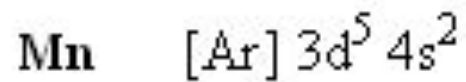

Aplicație: Determinați geometria și hibridizarea în: CrO_4^{-2} , VO_4^{-3} .

Hibridizare sp^3d

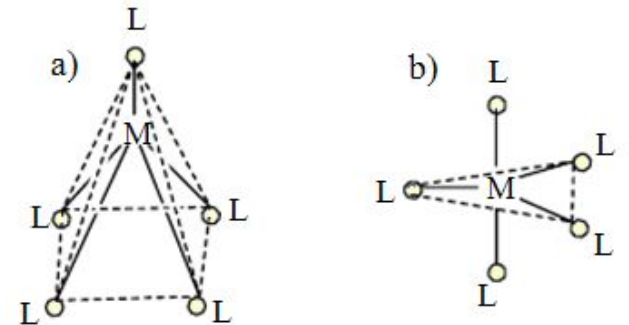
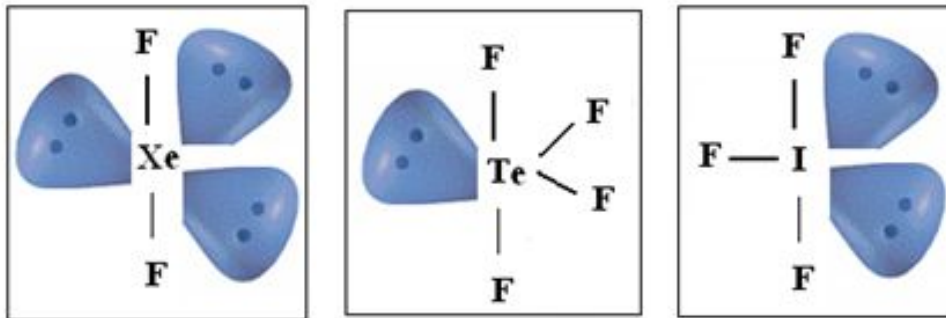
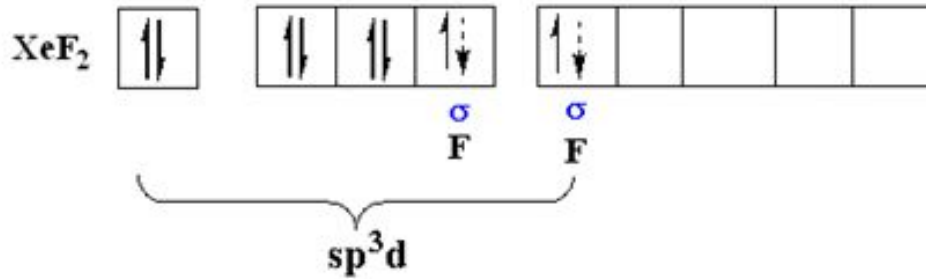
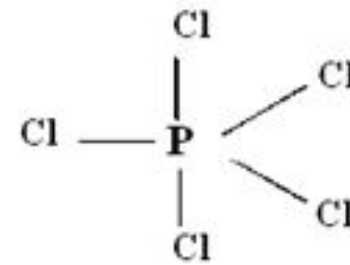
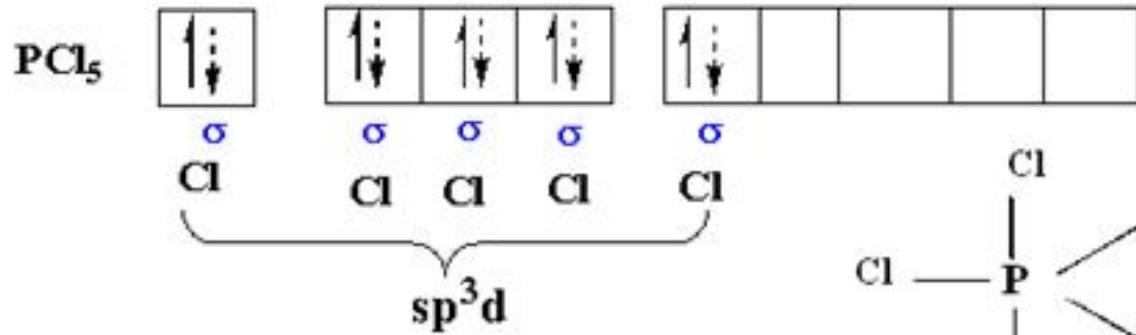

Geometrii caracteristice N.C.=5
a) piramidă tetragonală; b) bipiramidă trigonală

Aplicație: Determinați geometria și hibridizarea în: XeF₂, TeF₄, IF₃.

Hibridizare sp^3d^2 și d^2sp^3

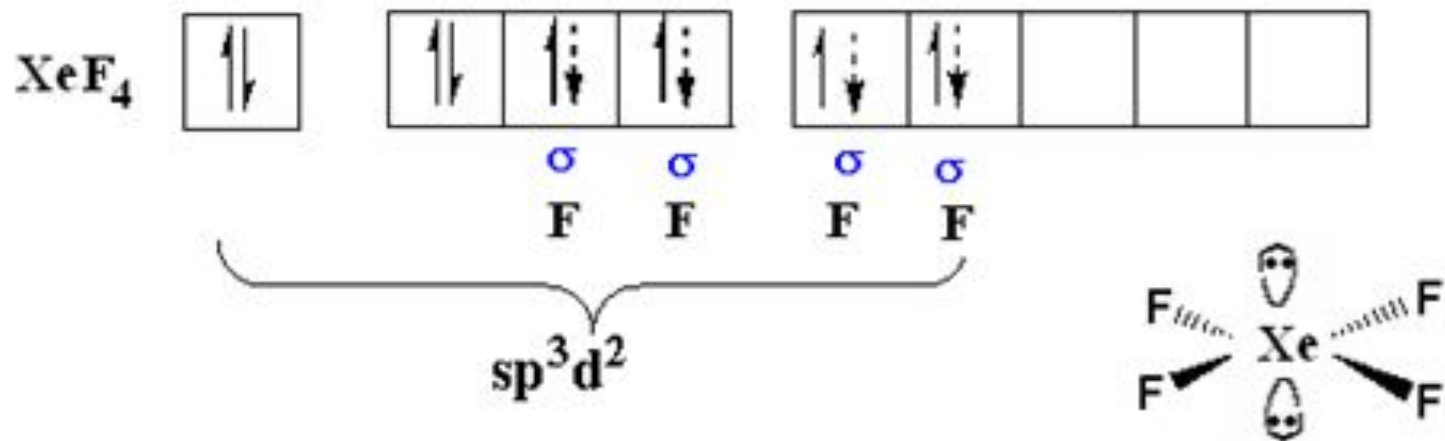
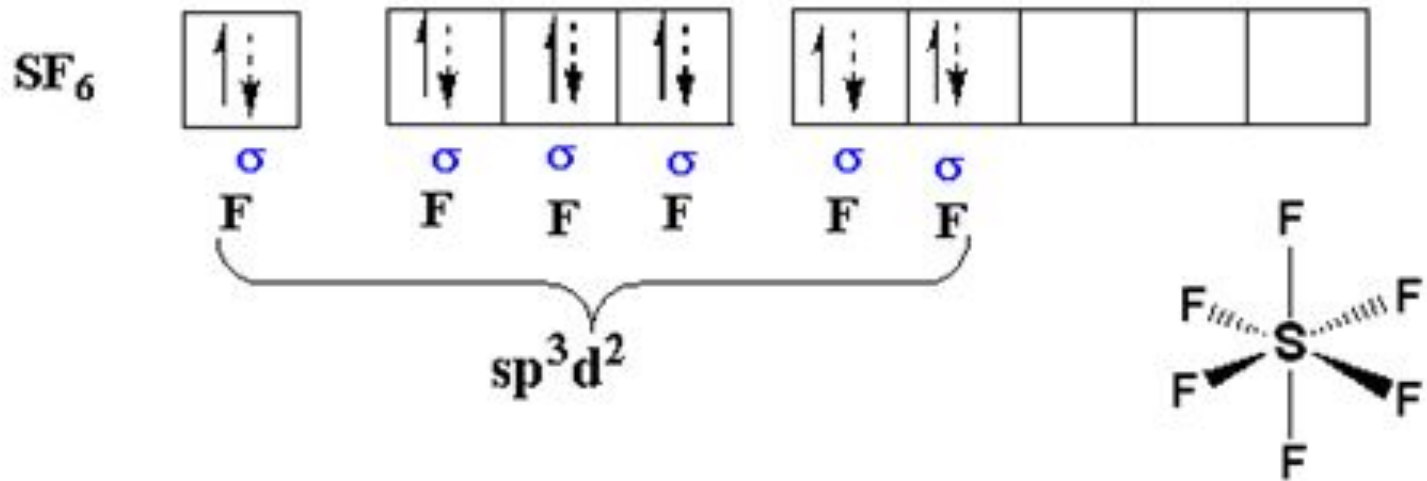

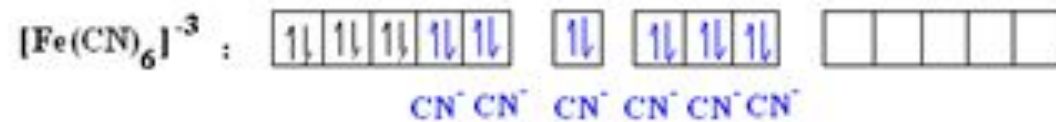
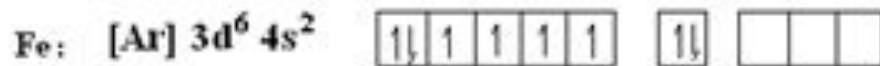

- complex de sferă interioară
- proprietăți diamagnetice

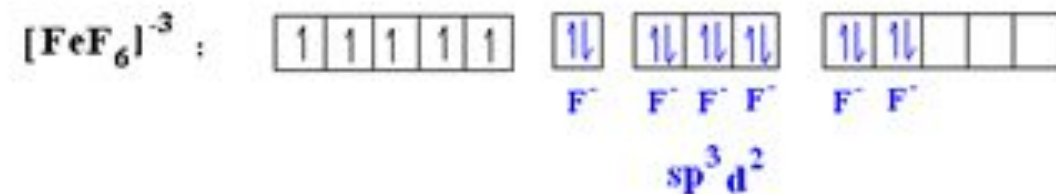

- complex de sferă exterioară
- proprietăți paramagnetice

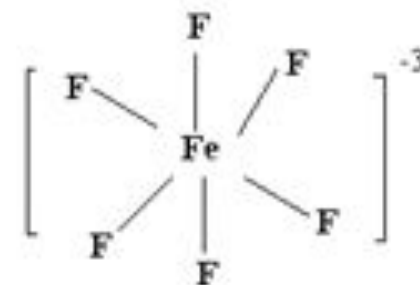
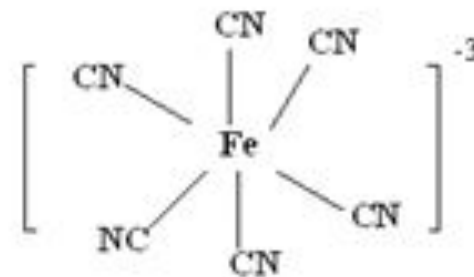

Hibridizare sp^3d^3

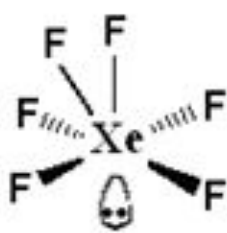
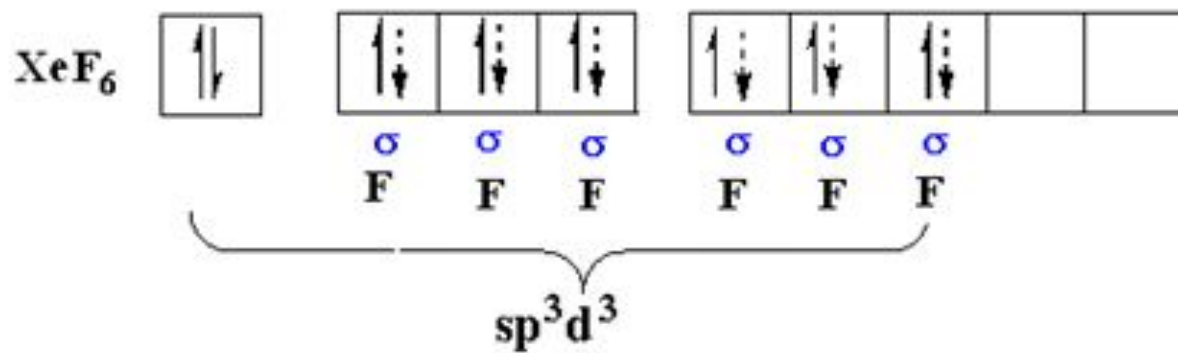
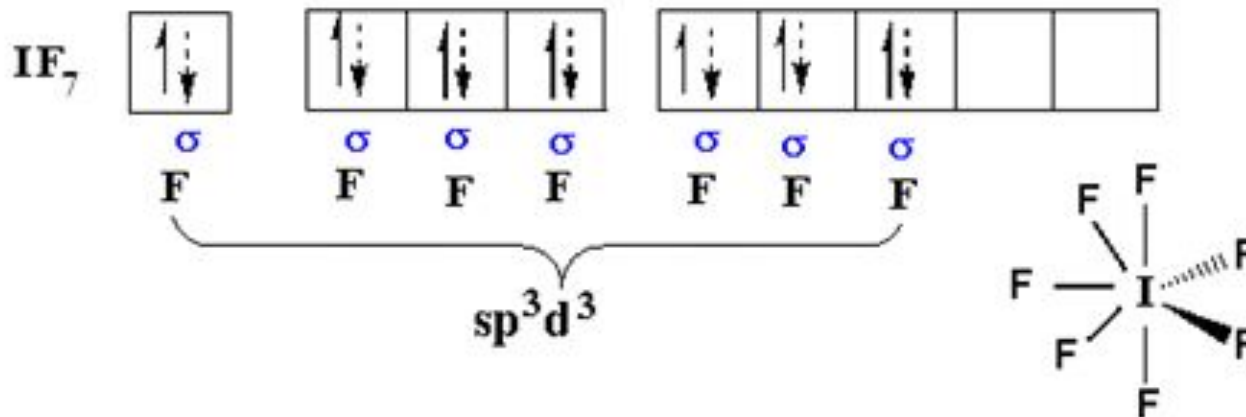

sau

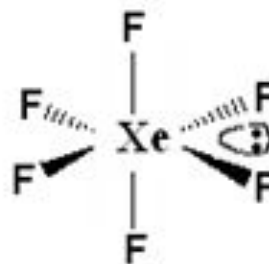

Aplicații:

1. Determinați hibridizarea și geometria în următorii compuși:

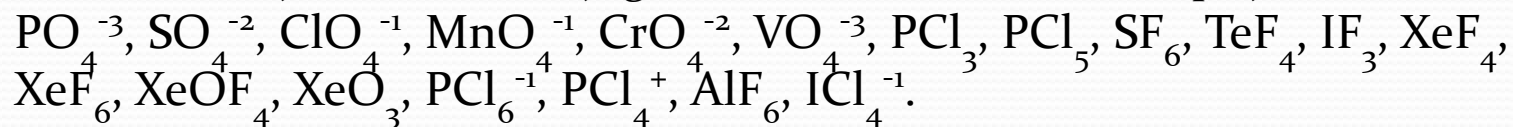

2. Modelați formarea legăturilor ionice din următorii compuși:



3. Modelați formarea legăturilor covalente în următoarele molecule:



4. Determinați hibridizarea și geometria în următorii compuși:

