

Угол между векторами

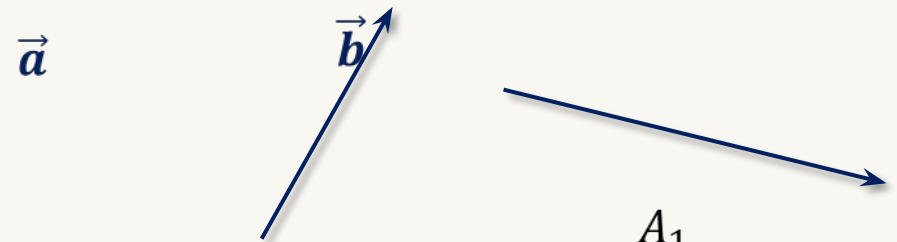

A

A₁

«Угол между векторами \vec{a} и \vec{b} равен α .»

«Угол между векторами \vec{a} и \vec{b} равен α .»

$$\vec{a} \vec{b} = \alpha$$

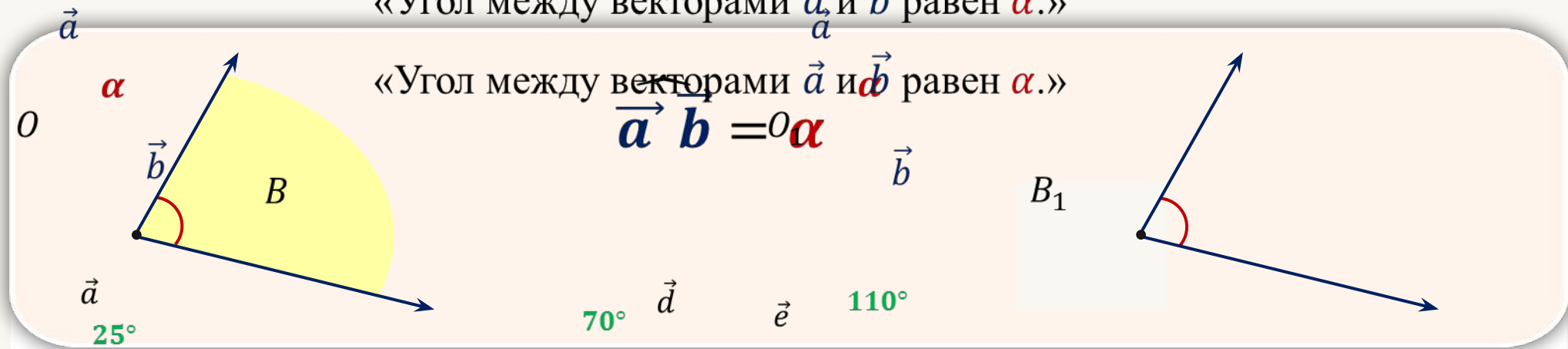

\vec{a}
25°

70°

110°

Пример:

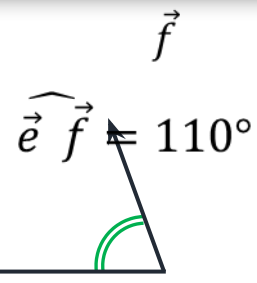
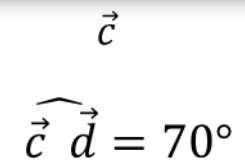
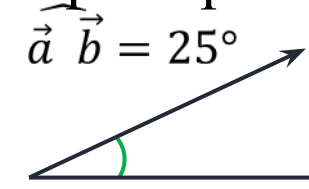

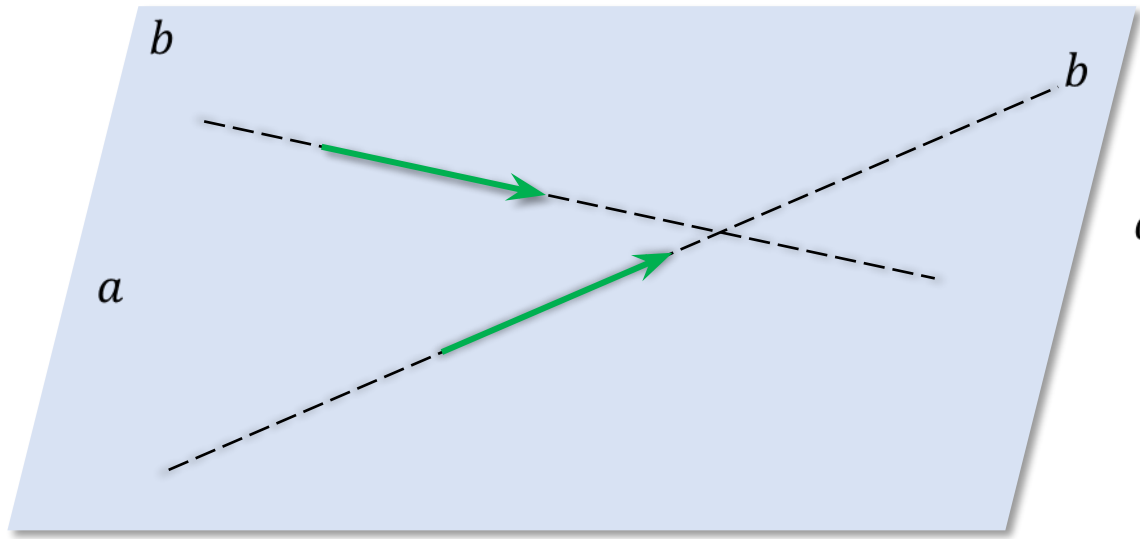

a

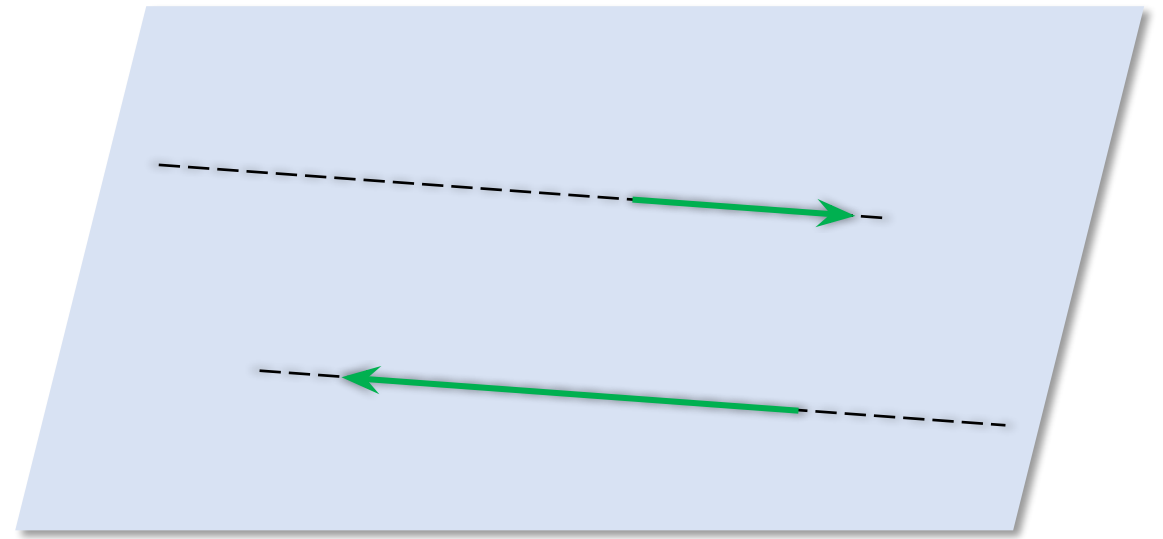

a

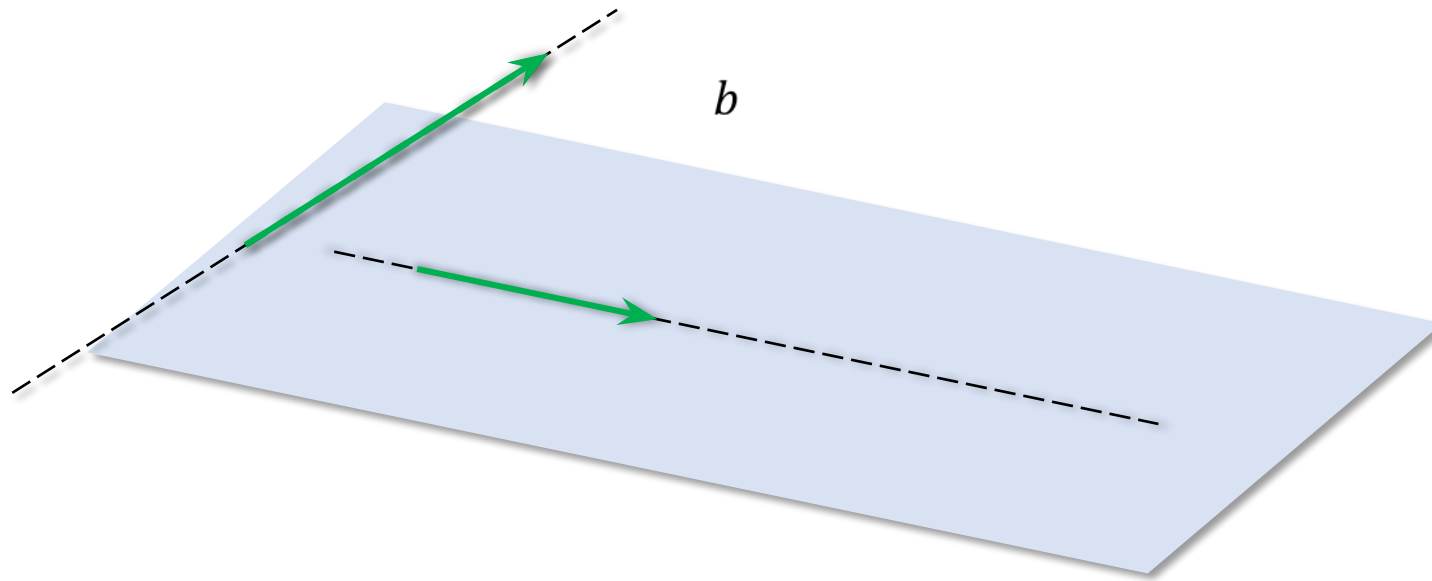

b

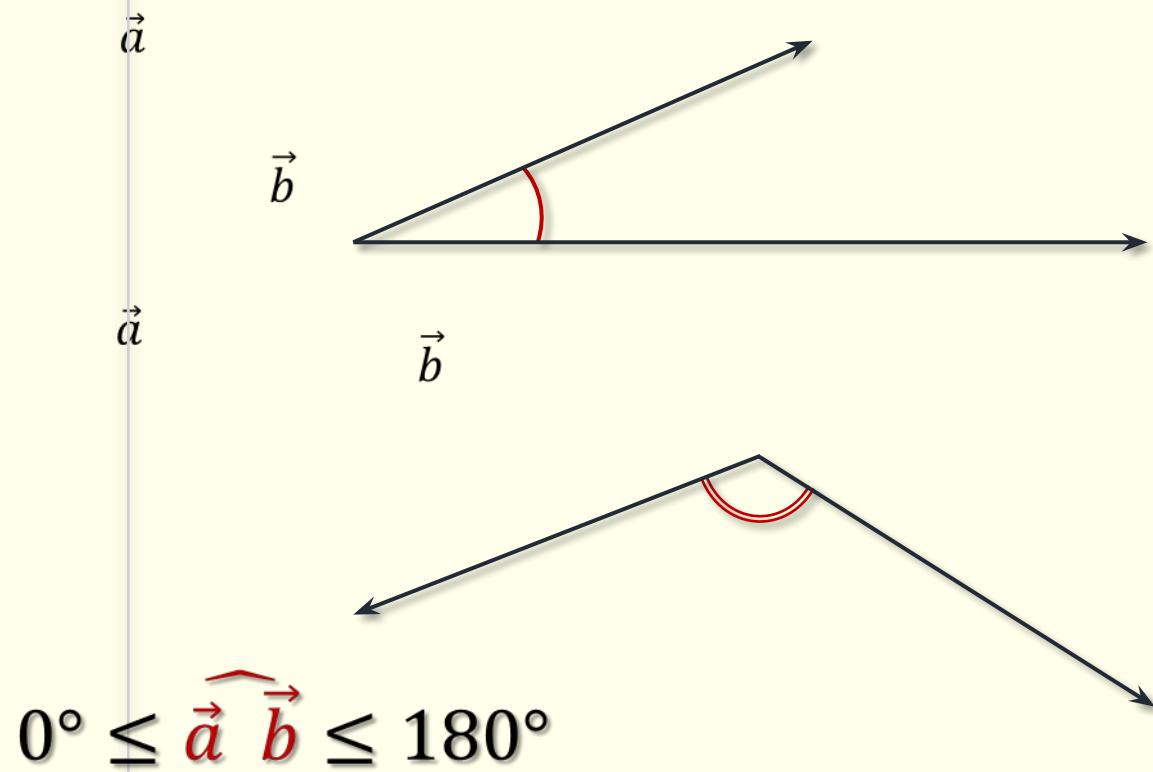
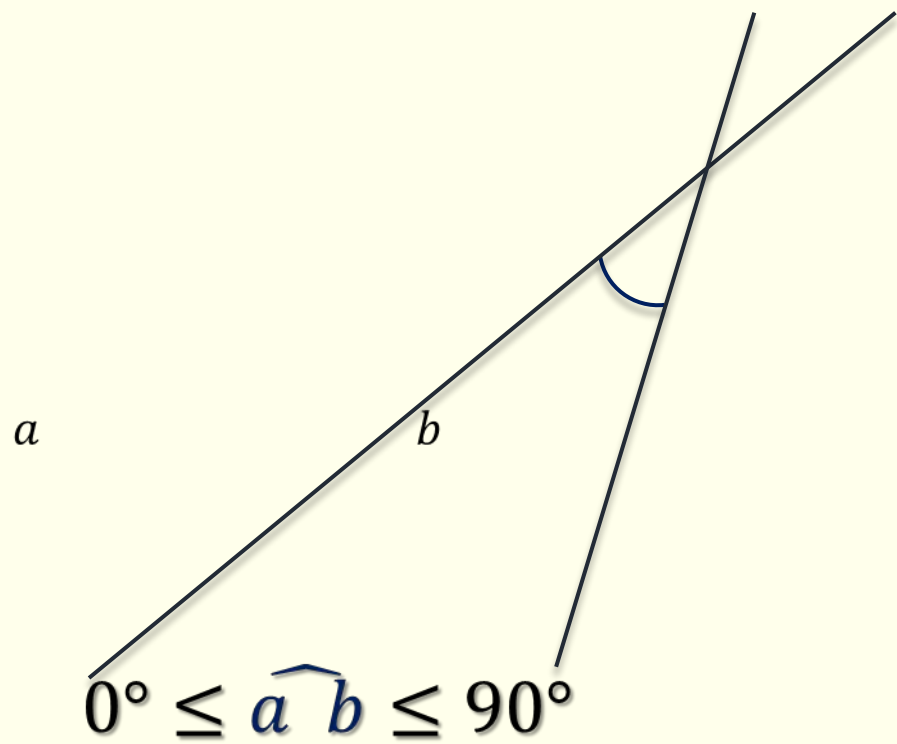

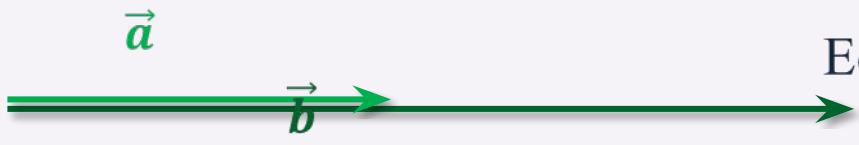

Если $\vec{a} \uparrow\uparrow \vec{b}$, то $\widehat{\vec{a} \vec{b}} = 0^\circ$.

\vec{a}

\vec{b}

\vec{a}

\vec{b}

\vec{b}

\vec{a}

Если $\vec{a} = \vec{0}$, то $\widehat{\vec{a} \vec{b}} = 0^\circ$.

Если $\vec{b} = \vec{0}$, то $\widehat{\vec{a} \vec{b}} = 0^\circ$.

Если $\vec{a} = \vec{b} = \vec{0}$, то $\widehat{\vec{a} \vec{b}} = 0^\circ$.

\vec{a}

\vec{a}

\vec{b}

\vec{b}

Если $\vec{a} \uparrow\downarrow \vec{b}$, то $\widehat{\vec{a} \vec{b}} = 180^\circ$.

Если $\vec{a} \perp \vec{b}$, то $\widehat{\vec{a} \vec{b}} = 90^\circ$.

*перпендикулярные
векторы*

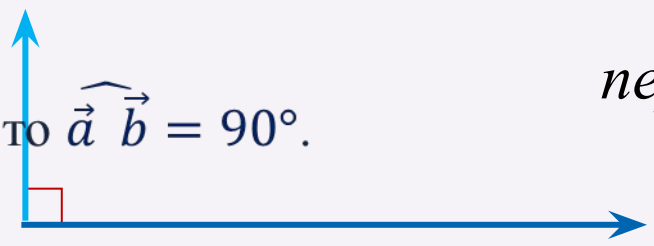

a) $\widehat{\overrightarrow{B_1B} \overrightarrow{B_1C}} = 45^\circ$

б) $\widehat{\overrightarrow{DA} \overrightarrow{B_1D_1}}$

в) $\widehat{\overrightarrow{A_1C_1} \overrightarrow{A_1B_1}}$

г) $\widehat{\overrightarrow{BC} \overrightarrow{AC}}$

д) $\widehat{\overrightarrow{BB_1} \overrightarrow{AC}}$

е) $\widehat{\overrightarrow{B_1C} \overrightarrow{AD_1}}$

ж) $\widehat{\overrightarrow{A_1D_1} \overrightarrow{BC}}$

з) $\widehat{\overrightarrow{AA_1} \overrightarrow{C_1C}}$

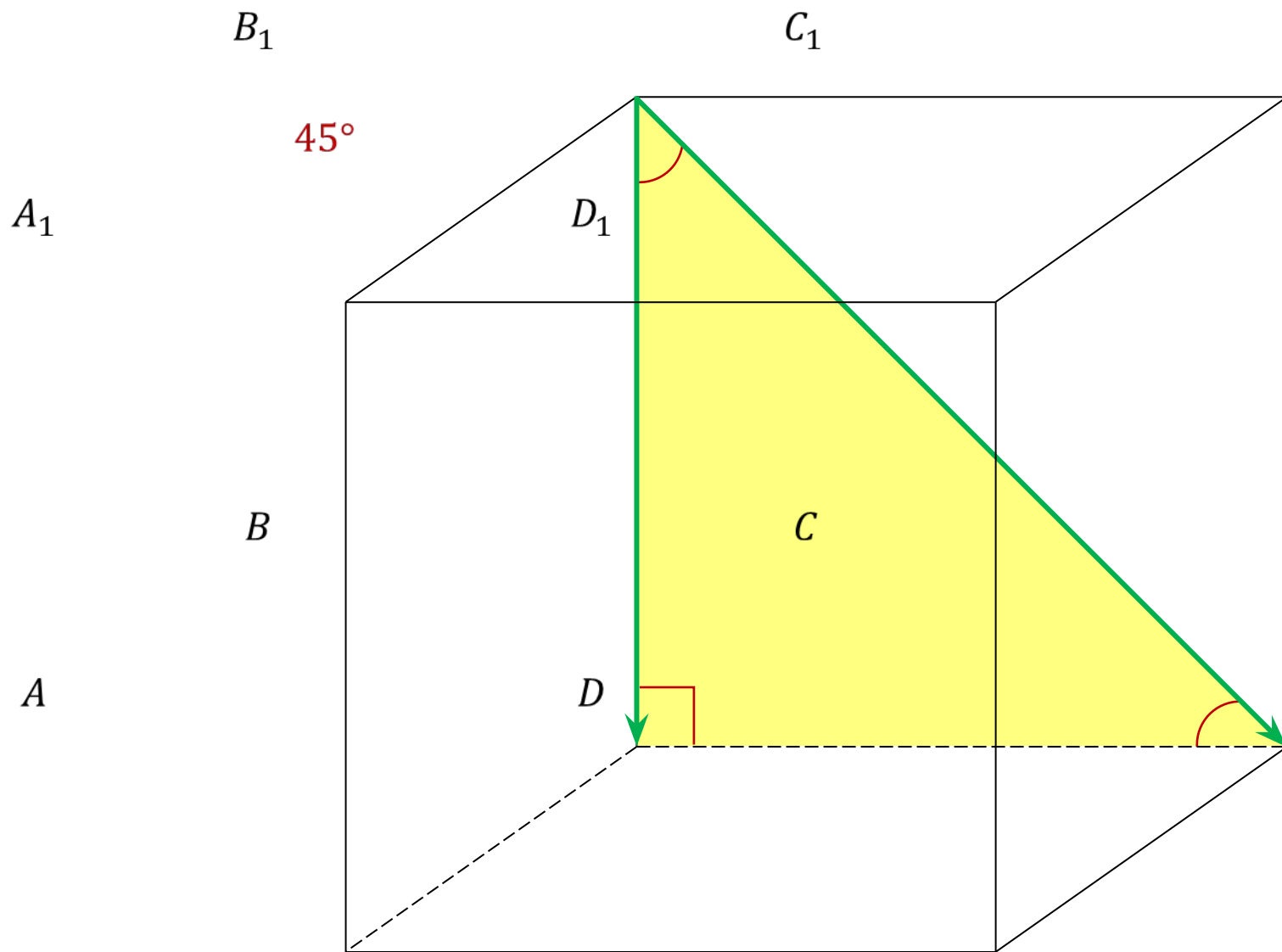

a) $\widehat{\overrightarrow{B_1B} \overrightarrow{B_1C}} = 45^\circ$

b) $\widehat{\overrightarrow{DA} \overrightarrow{B_1D_1}} = 135^\circ$

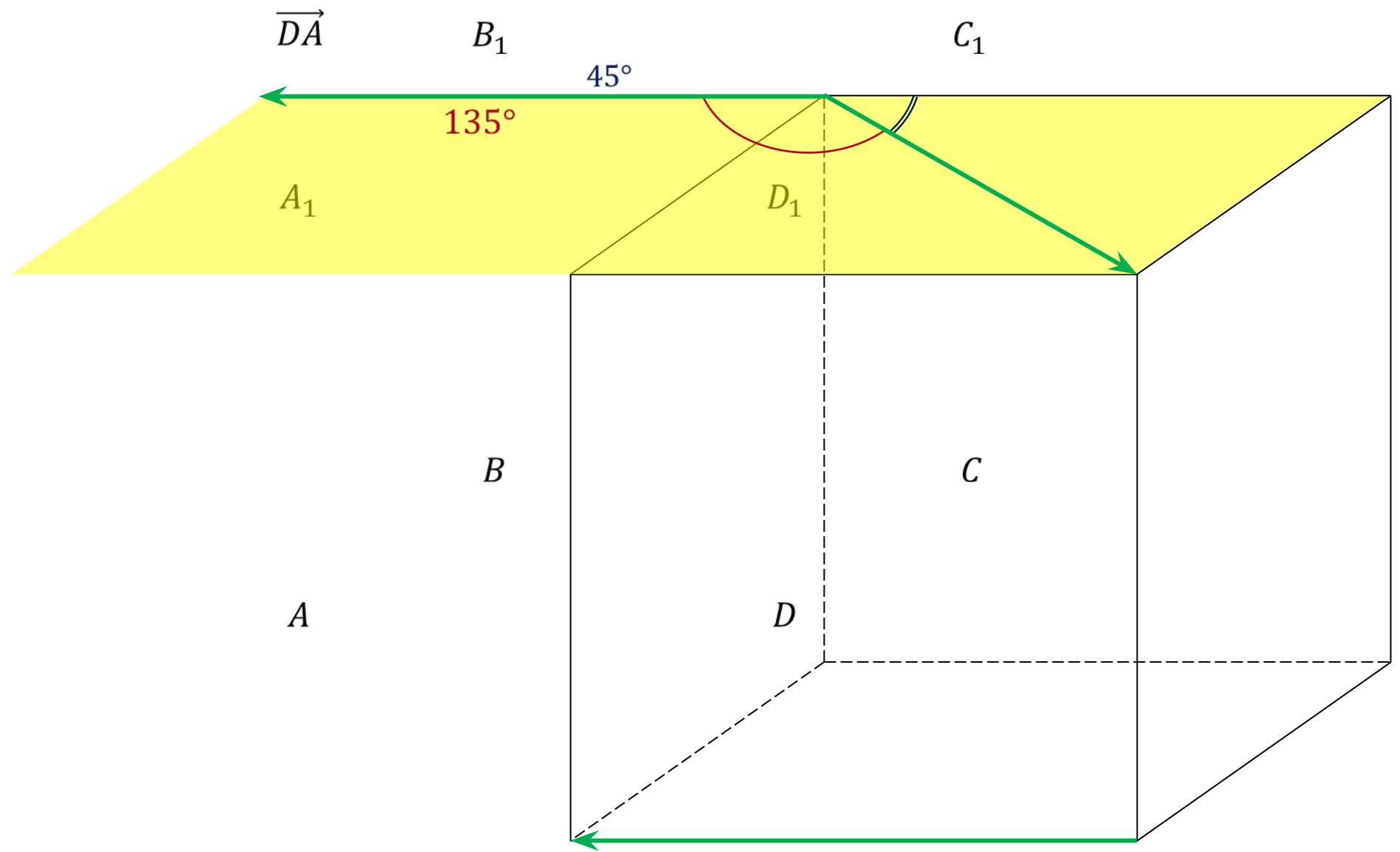

a) $\widehat{\overrightarrow{B_1B} \overrightarrow{B_1C}} = 45^\circ$

б) $\widehat{\overrightarrow{DA} \overrightarrow{B_1D_1}} = 135^\circ$

в) $\widehat{\overrightarrow{A_1C_1} \overrightarrow{A_1B_1}} = 45^\circ$

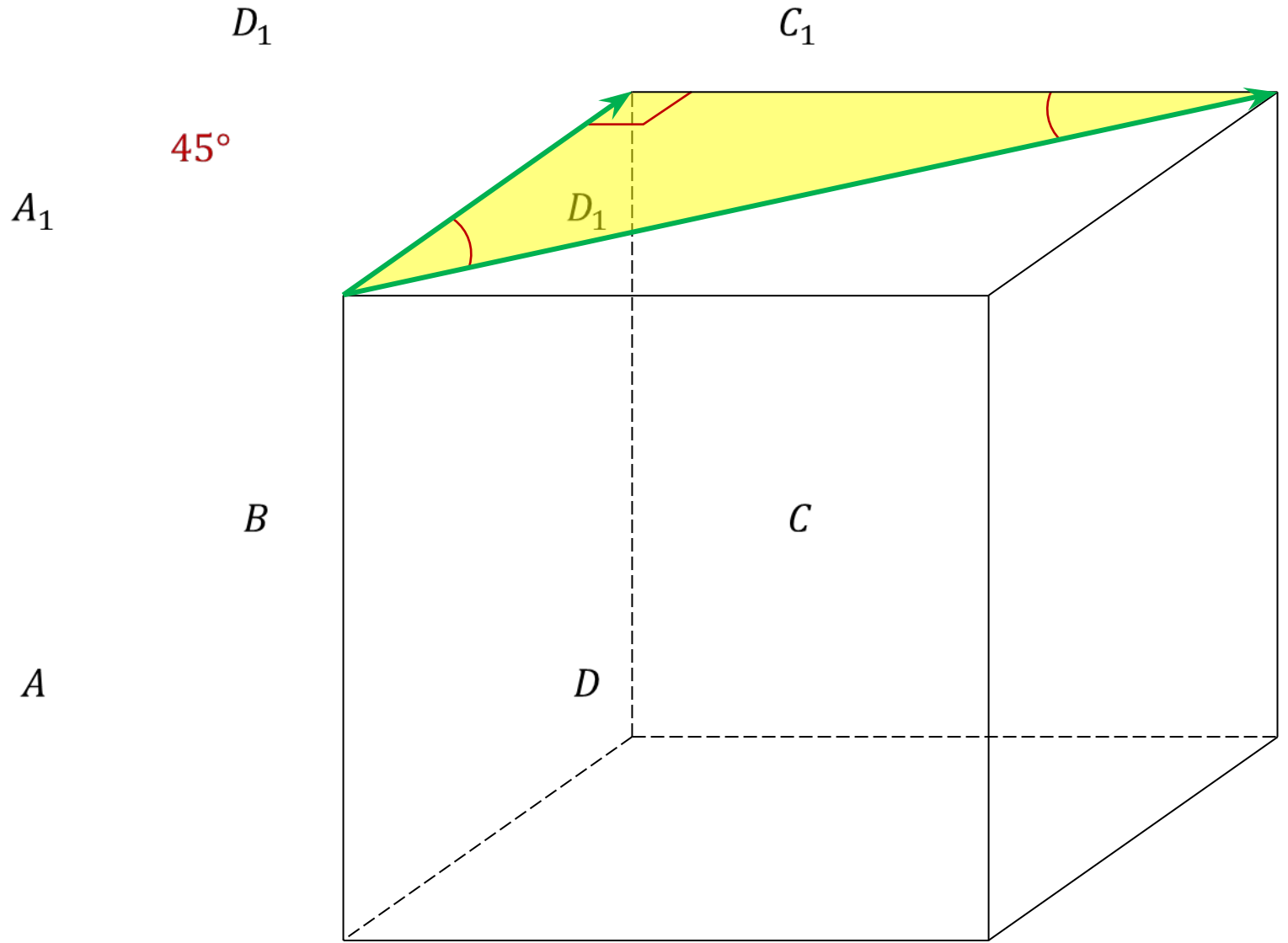

a) $\widehat{\overrightarrow{B_1B} \overrightarrow{B_1C}} = 45^\circ$

б) $\widehat{\overrightarrow{DA} \overrightarrow{B_1D_1}} = 135^\circ$

в) $\widehat{\overrightarrow{A_1C_1} \overrightarrow{A_1B_1}} = 45^\circ$

г) $\widehat{\overrightarrow{BC} \overrightarrow{AC}} = 45^\circ$

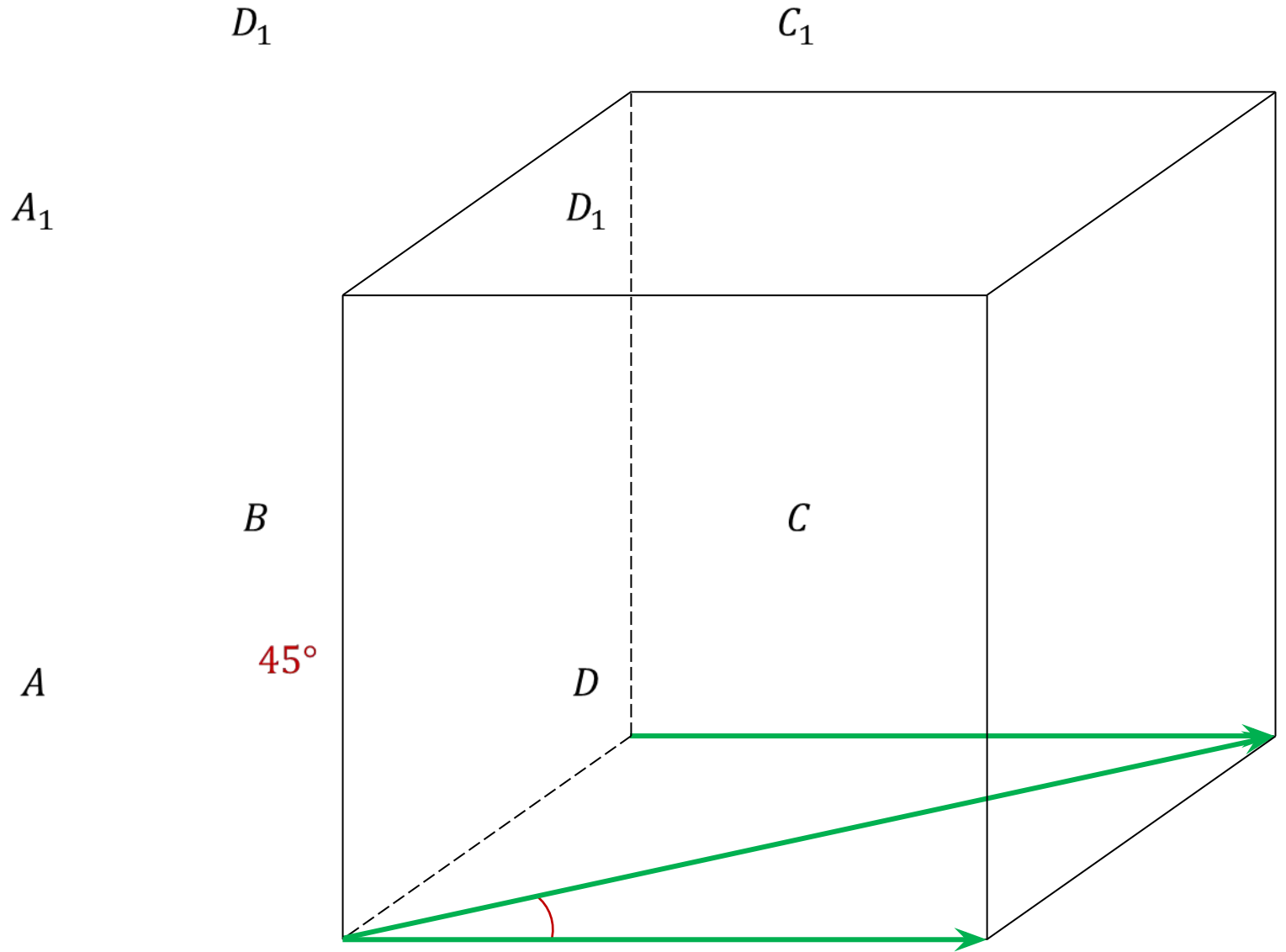

a) $\widehat{\overrightarrow{B_1B} \overrightarrow{B_1C}} = 45^\circ$

б) $\widehat{\overrightarrow{DA} \overrightarrow{B_1D_1}} = 135^\circ$

в) $\widehat{\overrightarrow{A_1C_1} \overrightarrow{A_1B_1}} = 45^\circ$

г) $\widehat{\overrightarrow{BC} \overrightarrow{AC}} = 45^\circ$

д) $\widehat{\overrightarrow{BB_1} \overrightarrow{AC}} = 90^\circ \Rightarrow \overrightarrow{BB_1} \perp \overrightarrow{AC}$

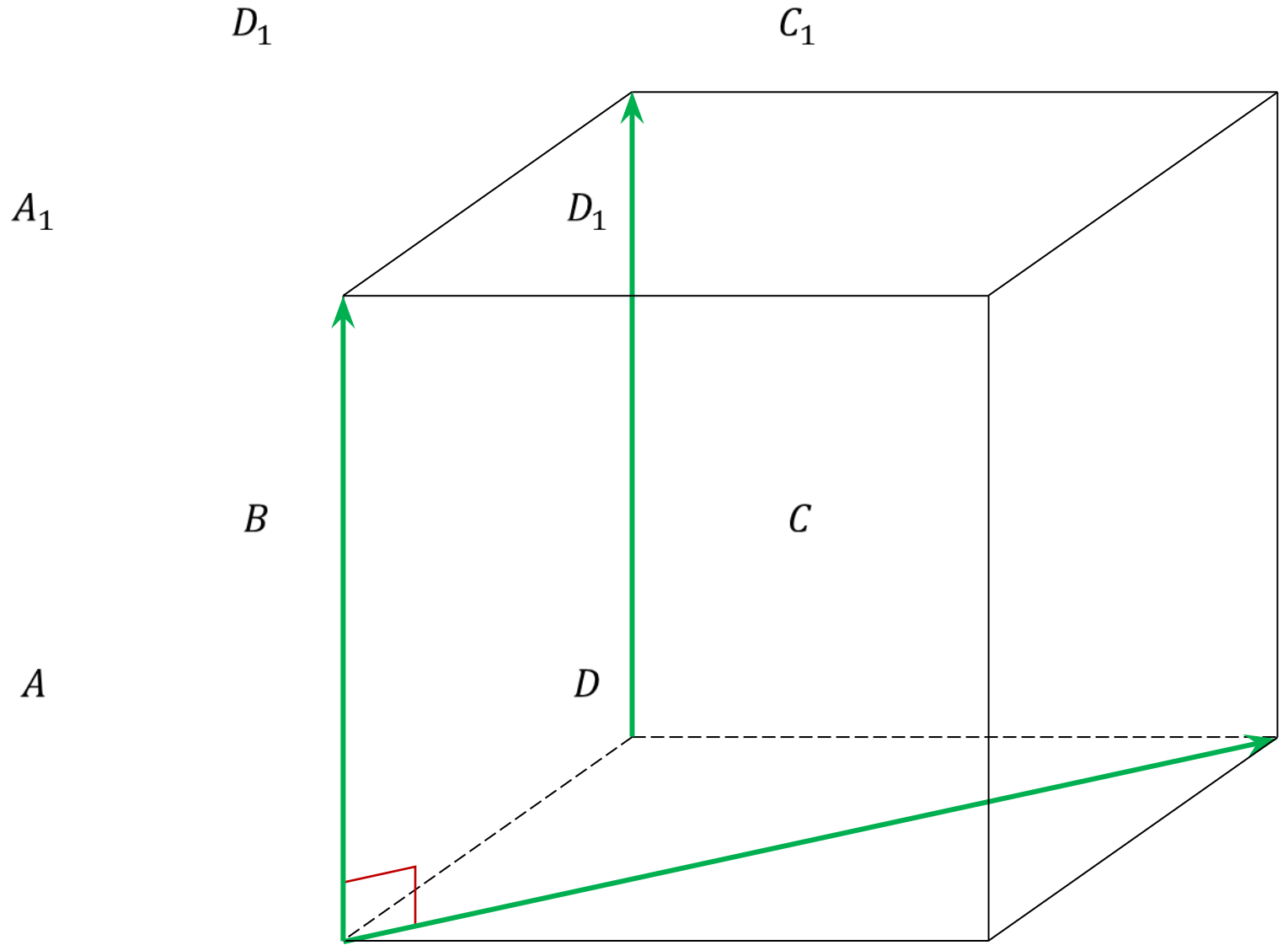

a) $\widehat{\overrightarrow{B_1B} \overrightarrow{B_1C}} = 45^\circ$

б) $\widehat{\overrightarrow{DA} \overrightarrow{B_1D_1}} = 135^\circ$

в) $\widehat{\overrightarrow{A_1C_1} \overrightarrow{A_1B_1}} = 45^\circ$

г) $\widehat{\overrightarrow{BC} \overrightarrow{AC}} = 45^\circ$

д) $\widehat{\overrightarrow{BB_1} \overrightarrow{AC}} = 90^\circ \Rightarrow \overrightarrow{BB_1} \perp \overrightarrow{AC}$

е) $\widehat{\overrightarrow{B_1C} \overrightarrow{AD_1}} = 90^\circ \Rightarrow \overrightarrow{B_1C} \perp \overrightarrow{AD_1}$

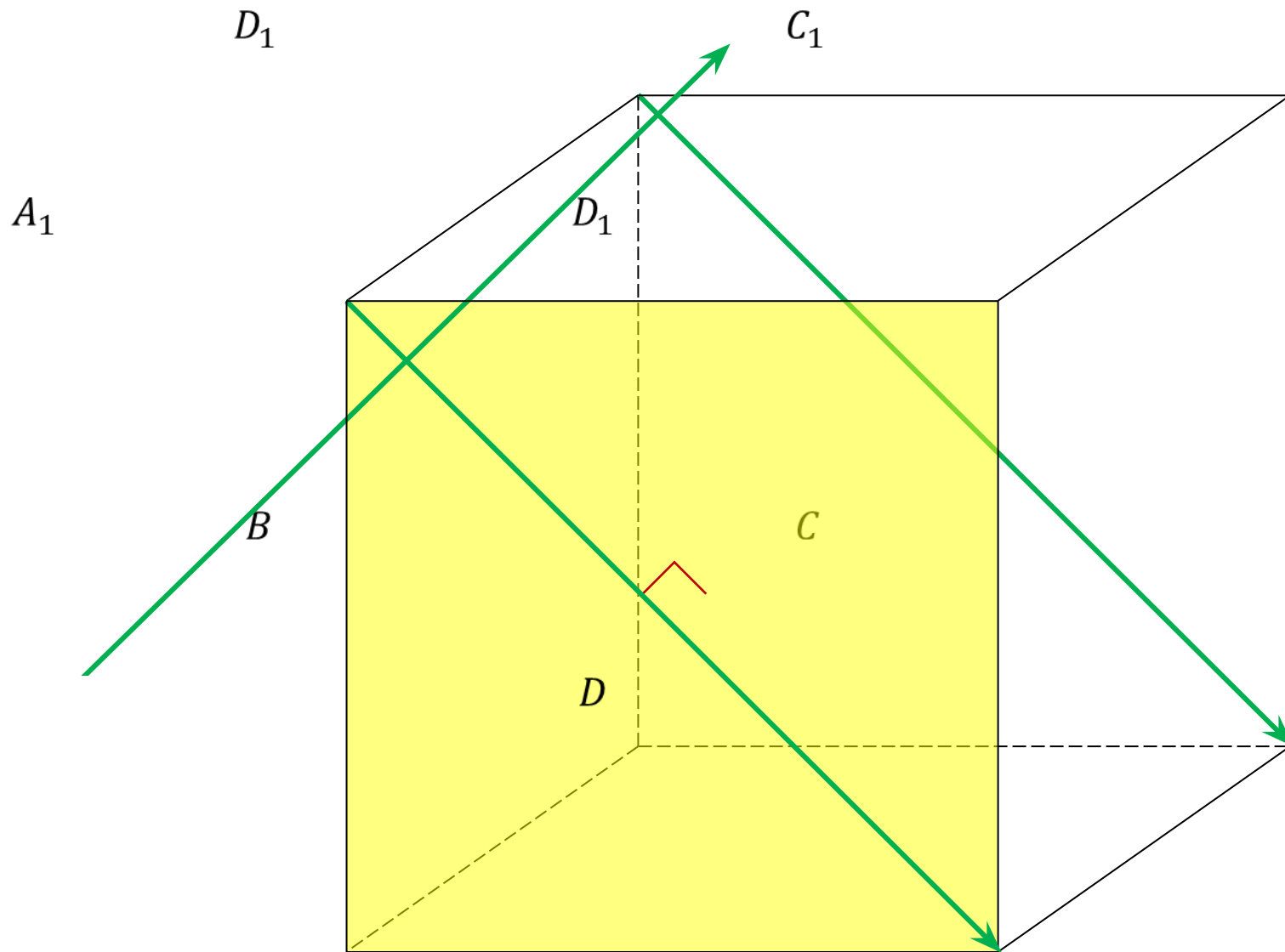

а) $\widehat{\overrightarrow{B_1B} \overrightarrow{B_1C}} = 45^\circ$

б) $\widehat{\overrightarrow{DA} \overrightarrow{B_1D_1}} = 135^\circ$

в) $\widehat{\overrightarrow{A_1C_1} \overrightarrow{A_1B_1}} = 45^\circ$

г) $\widehat{\overrightarrow{BC} \overrightarrow{AC}} = 45^\circ$

д) $\widehat{\overrightarrow{BB_1} \overrightarrow{AC}} = 90^\circ \Rightarrow \overrightarrow{BB_1} \perp \overrightarrow{AC}$

е) $\widehat{\overrightarrow{B_1C} \overrightarrow{AD_1}} = 90^\circ \Rightarrow \overrightarrow{B_1C} \perp \overrightarrow{AD_1}$

ж) $\widehat{\overrightarrow{A_1D_1} \overrightarrow{BC}} = 0^\circ$, так как $\overrightarrow{A_1D_1} \parallel \overrightarrow{BC}$

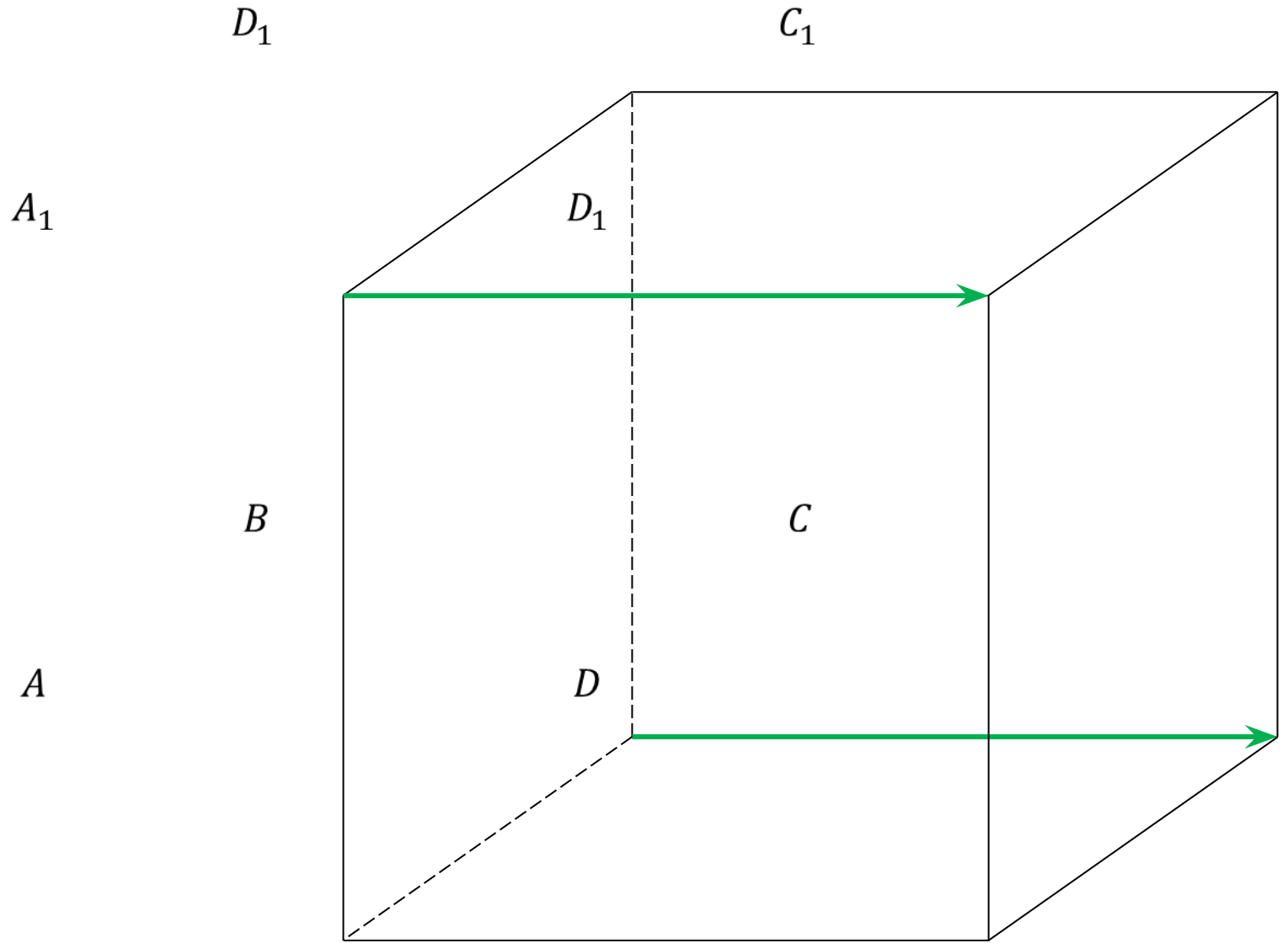

а) $\widehat{\overrightarrow{B_1B} \overrightarrow{B_1C}} = 45^\circ$

б) $\widehat{\overrightarrow{DA} \overrightarrow{B_1D_1}} = 135^\circ$

в) $\widehat{\overrightarrow{A_1C_1} \overrightarrow{A_1B_1}} = 45^\circ$

г) $\widehat{\overrightarrow{BC} \overrightarrow{AC}} = 45^\circ$

д) $\widehat{\overrightarrow{BB_1} \overrightarrow{AC}} = 90^\circ \Rightarrow \overrightarrow{BB_1} \perp \overrightarrow{AC}$

е) $\widehat{\overrightarrow{B_1C} \overrightarrow{AD_1}} = 90^\circ \Rightarrow \overrightarrow{B_1C} \perp \overrightarrow{AD_1}$

ж) $\widehat{\overrightarrow{A_1D_1} \overrightarrow{BC}} = 0^\circ$, так как $\overrightarrow{A_1D_1} \parallel \overrightarrow{BC}$

з) $\widehat{\overrightarrow{AA_1} \overrightarrow{C_1C}} = 180^\circ$, так как $\overrightarrow{AA_1} \updownarrow \overrightarrow{C_1C}$

A_1

A

D_1

C_1

B

C

D

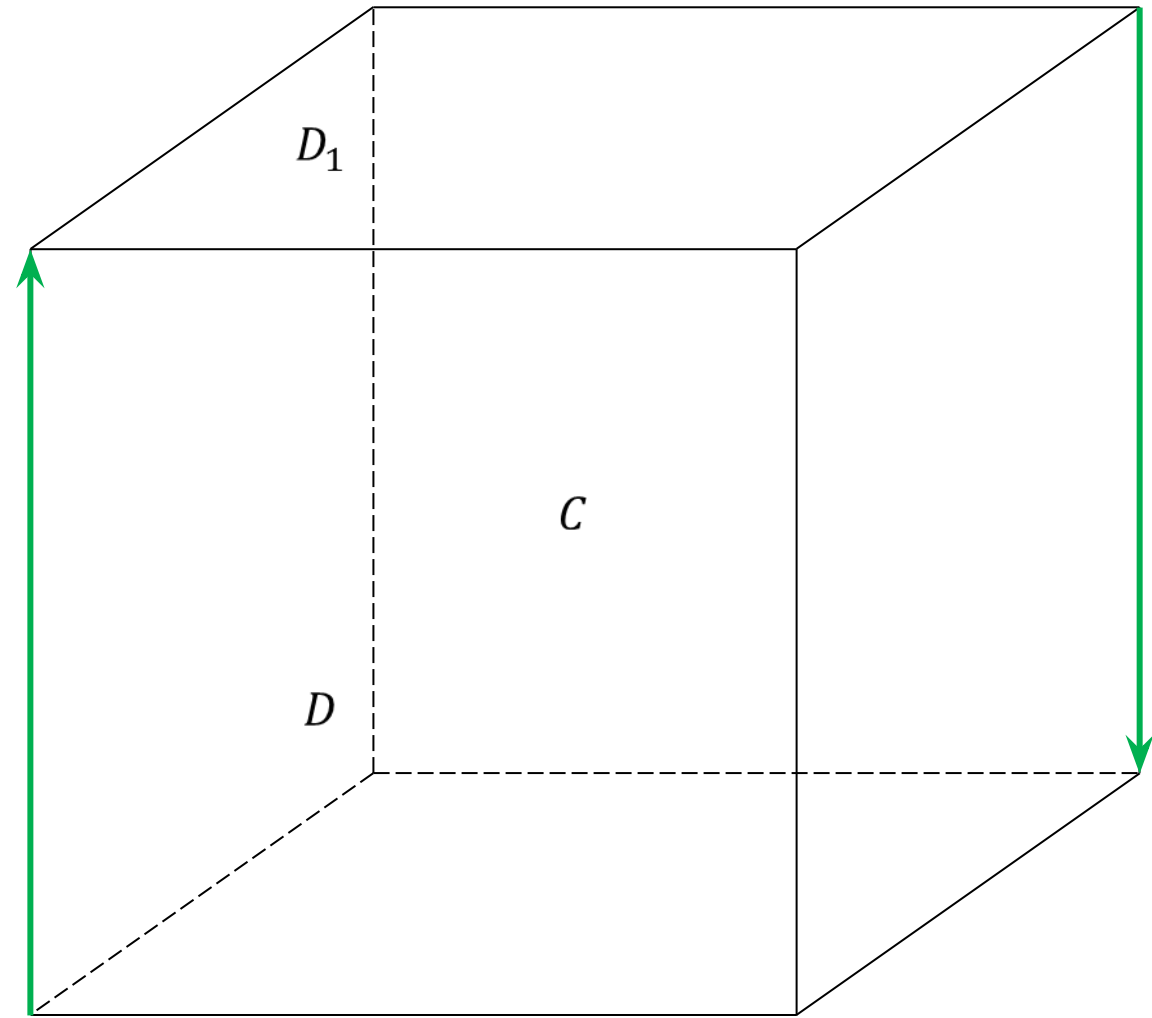

$$\overrightarrow{AB} \overleftarrow{CD} = \varphi$$

$$\overrightarrow{BA} \overleftarrow{DC}$$

$$\overrightarrow{BA} \overrightarrow{CD}$$

$$\overrightarrow{AB} \overrightarrow{DC}$$

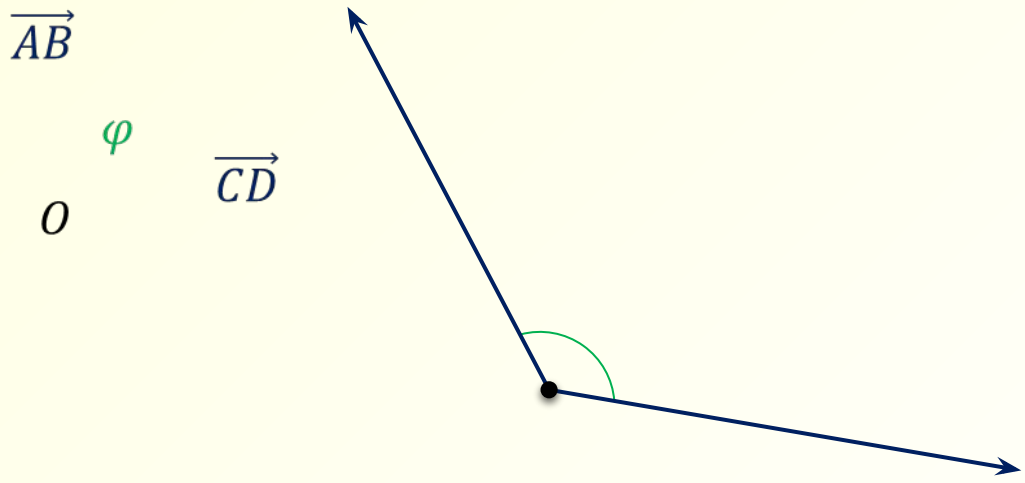
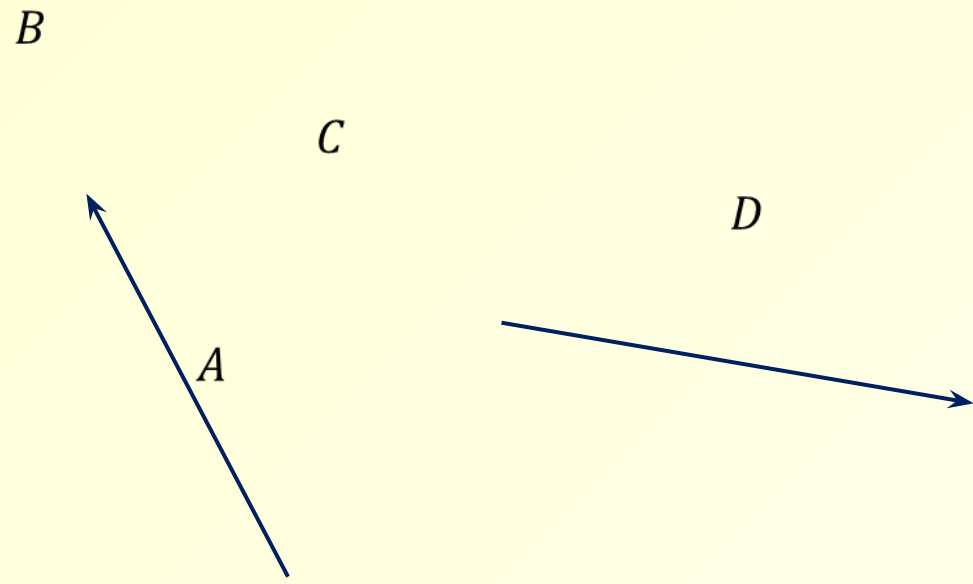

$$\overrightarrow{AB} \overrightarrow{CD} = \varphi$$

$$\overrightarrow{BA} \overrightarrow{DC} = \varphi$$

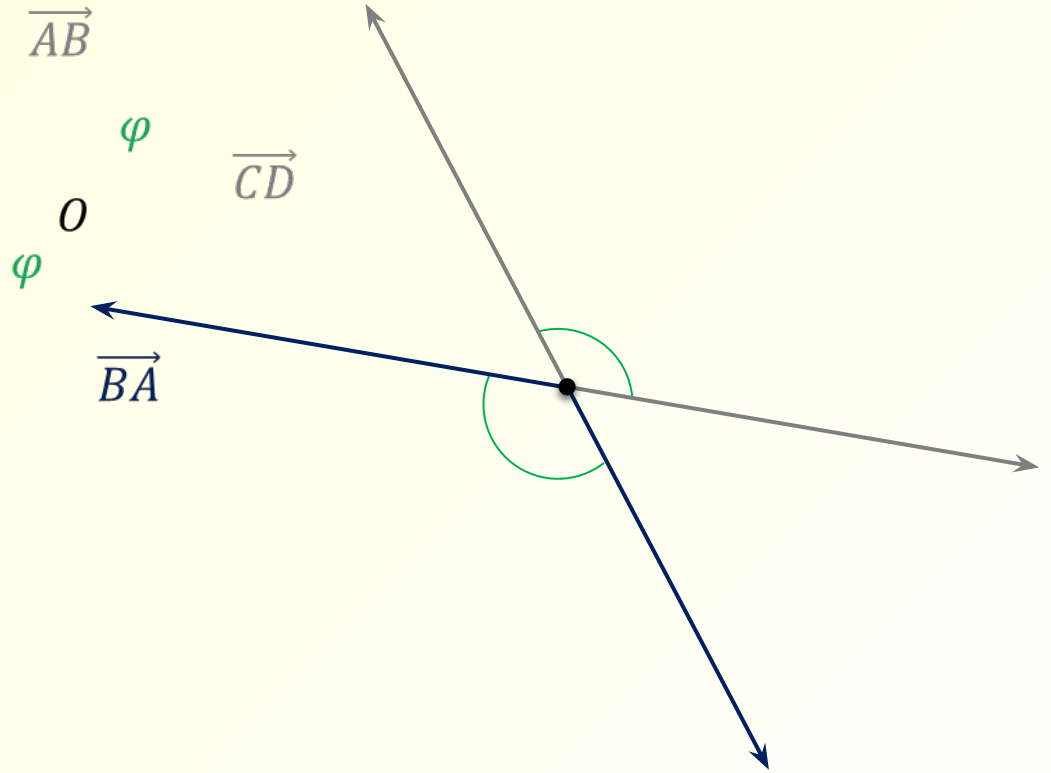
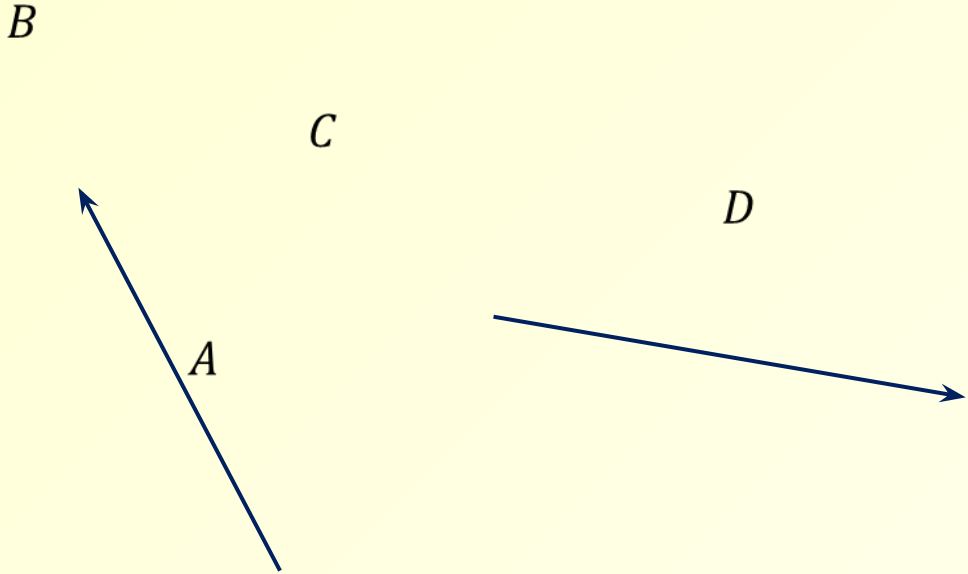

$$\widehat{\overrightarrow{AB} \overrightarrow{CD}} = \varphi$$

$$\widehat{\overrightarrow{BA} \overrightarrow{DC}} = \varphi$$

$$\widehat{\overrightarrow{BA} \overrightarrow{CD}} = 180^\circ - \varphi$$

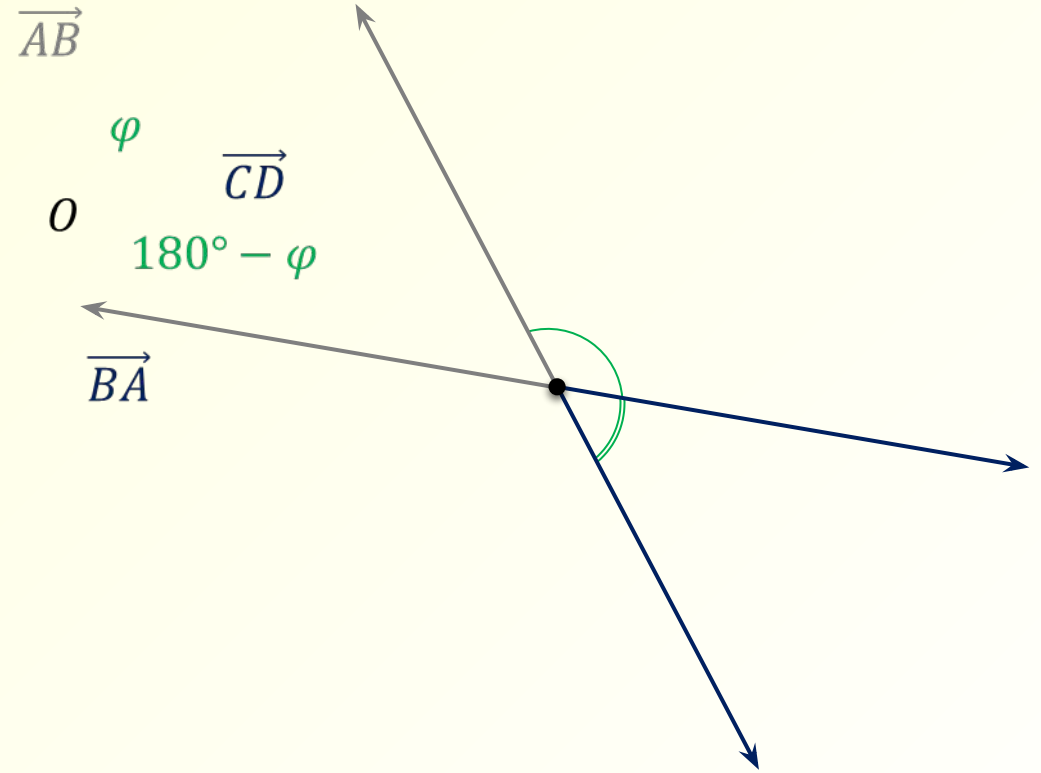
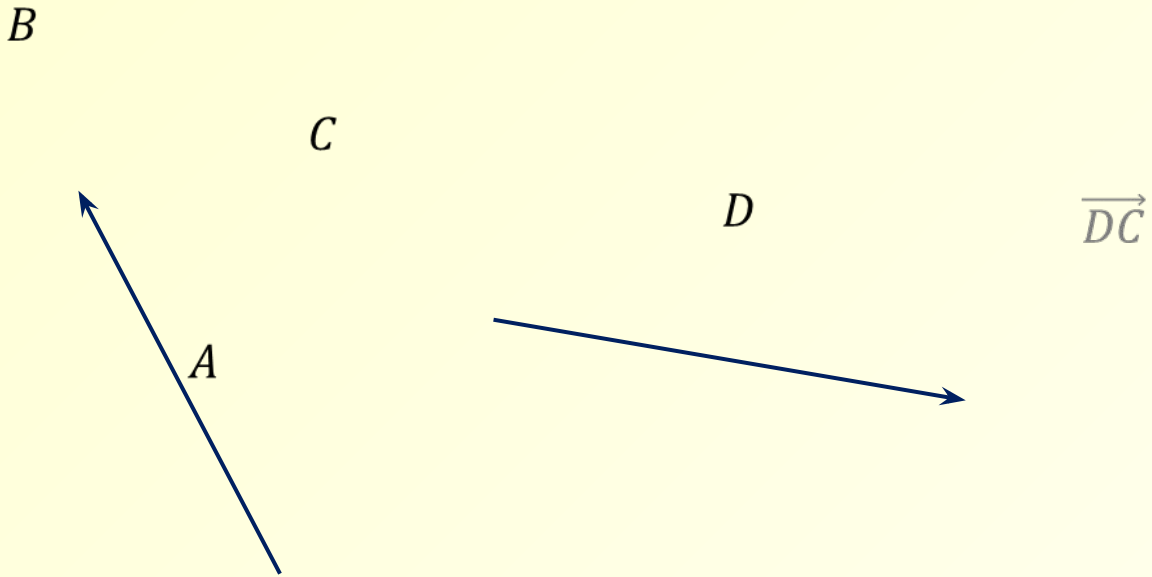

$$\widehat{\overrightarrow{AB} \overrightarrow{CD}} = \varphi$$

$$\widehat{\overrightarrow{BA} \overrightarrow{DC}} = \varphi$$

$$\widehat{\overrightarrow{BA} \overrightarrow{CD}} = 180^\circ - \varphi$$

$$\widehat{\overrightarrow{AB} \overrightarrow{DC}} = 180^\circ - \varphi$$

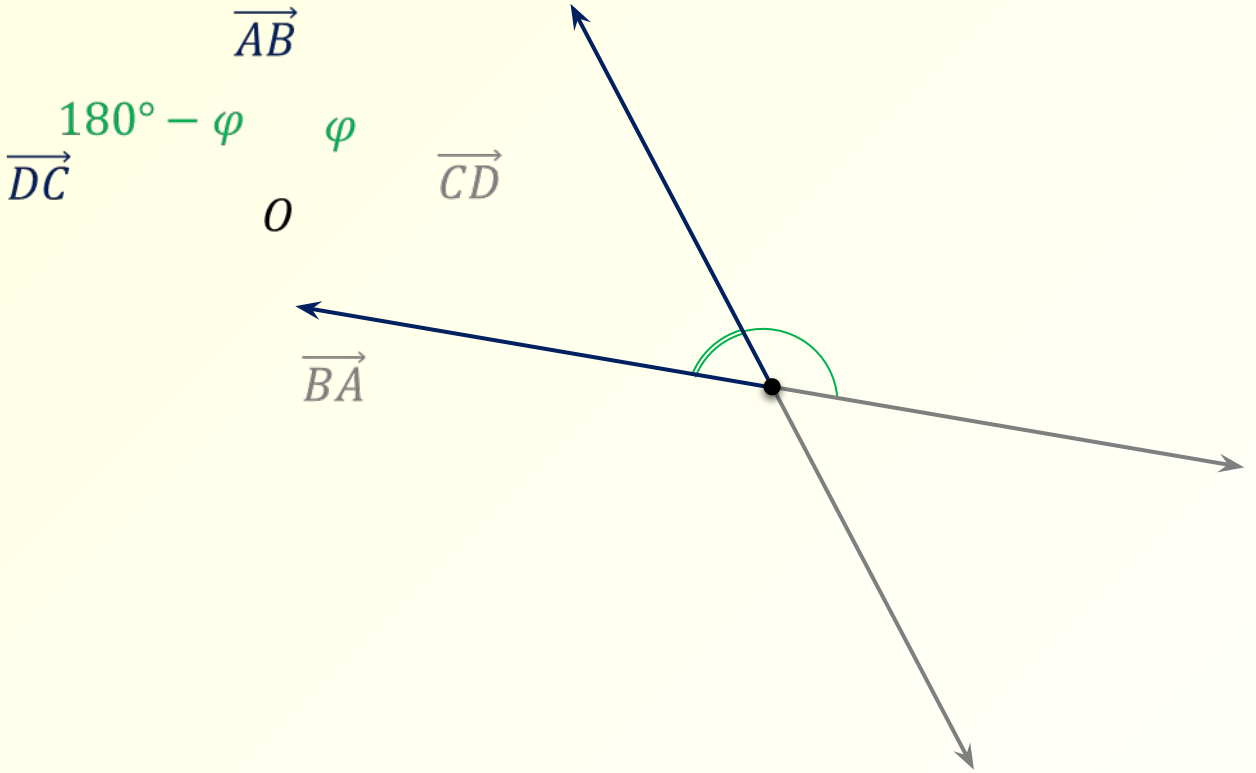
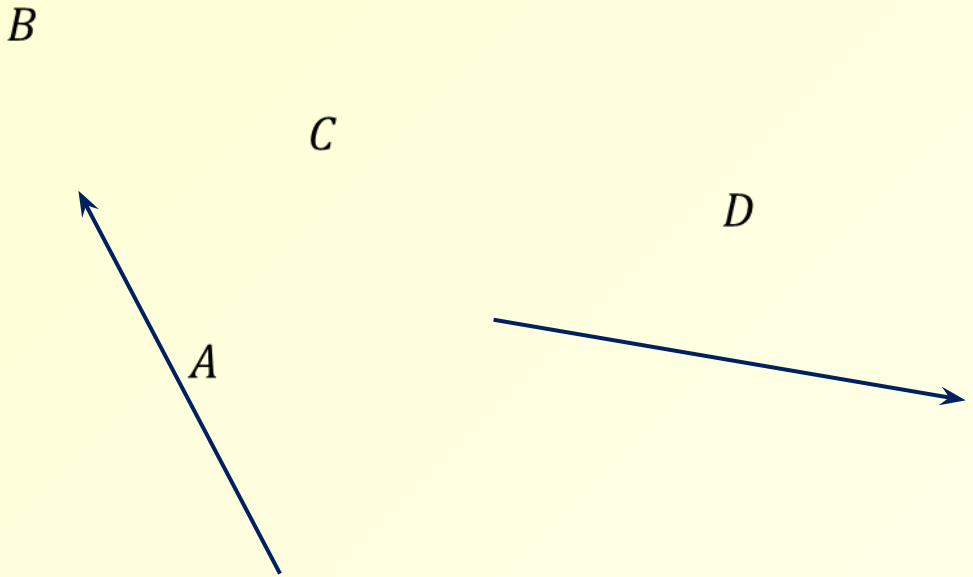

Угол между векторами

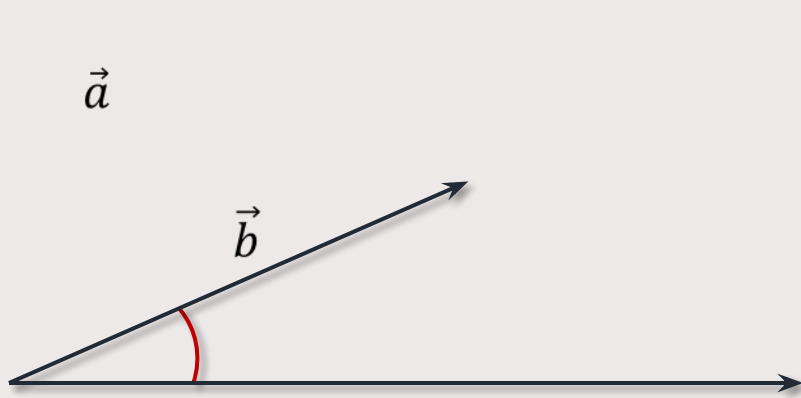

$$0^\circ \leq \widehat{\vec{a} \vec{b}} \leq 180^\circ$$

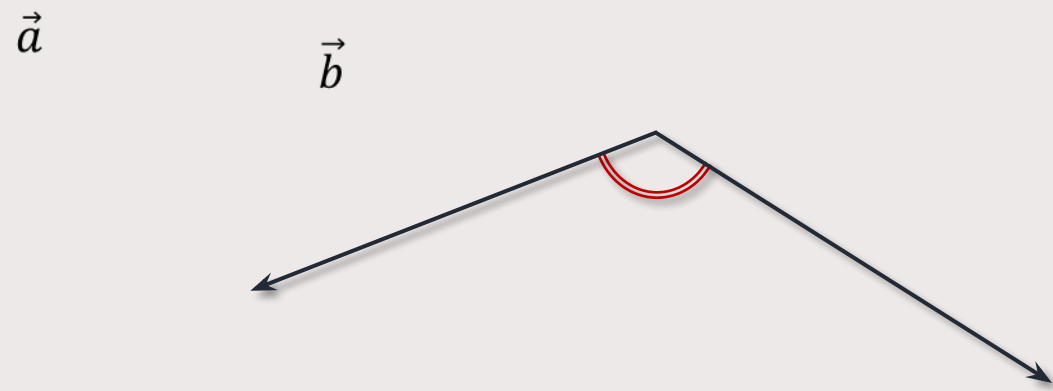

Угол между векторами

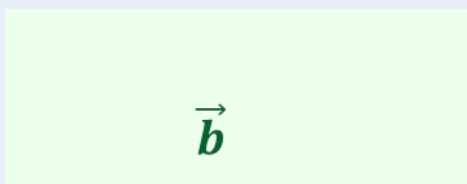

\vec{a}

\vec{b}

\vec{a}

\vec{b}

\vec{b}

\vec{a}

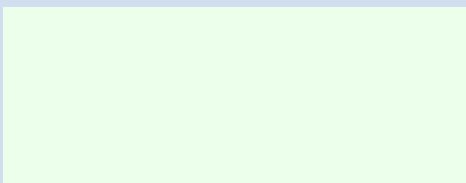

\vec{b}

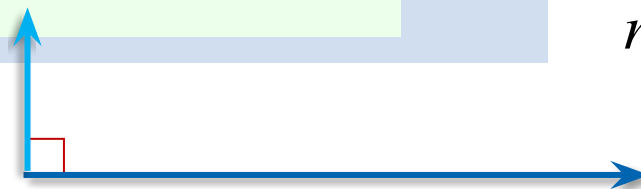
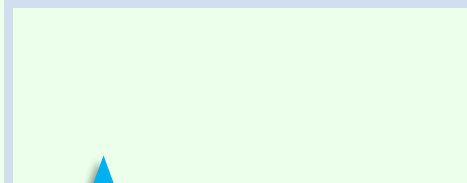

*перпендикулярные
векторы*