

Геометрические фигуры и их развертки.

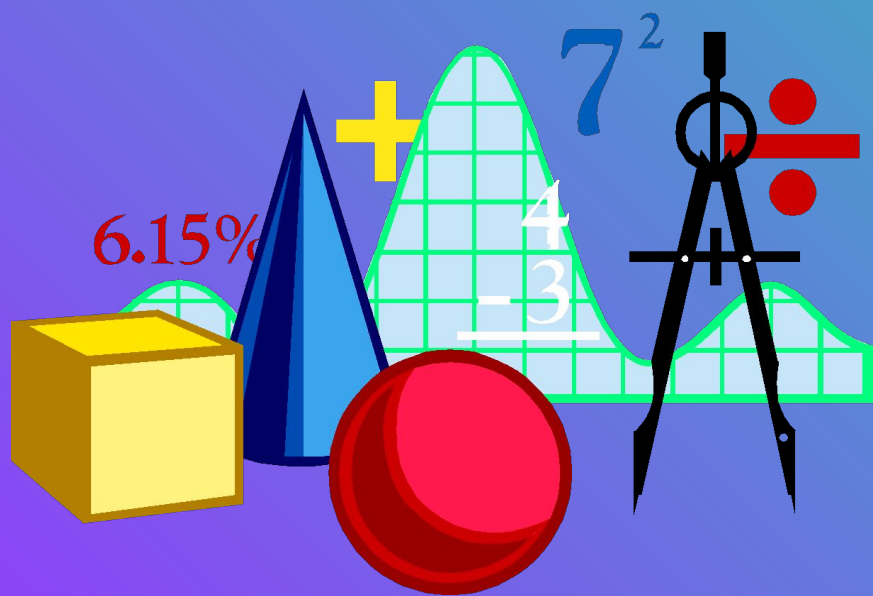

*Презентация выполнена
Делидовой Л.В.,*

*Учителем математики
МАОУ «Ашанская СОШ»*

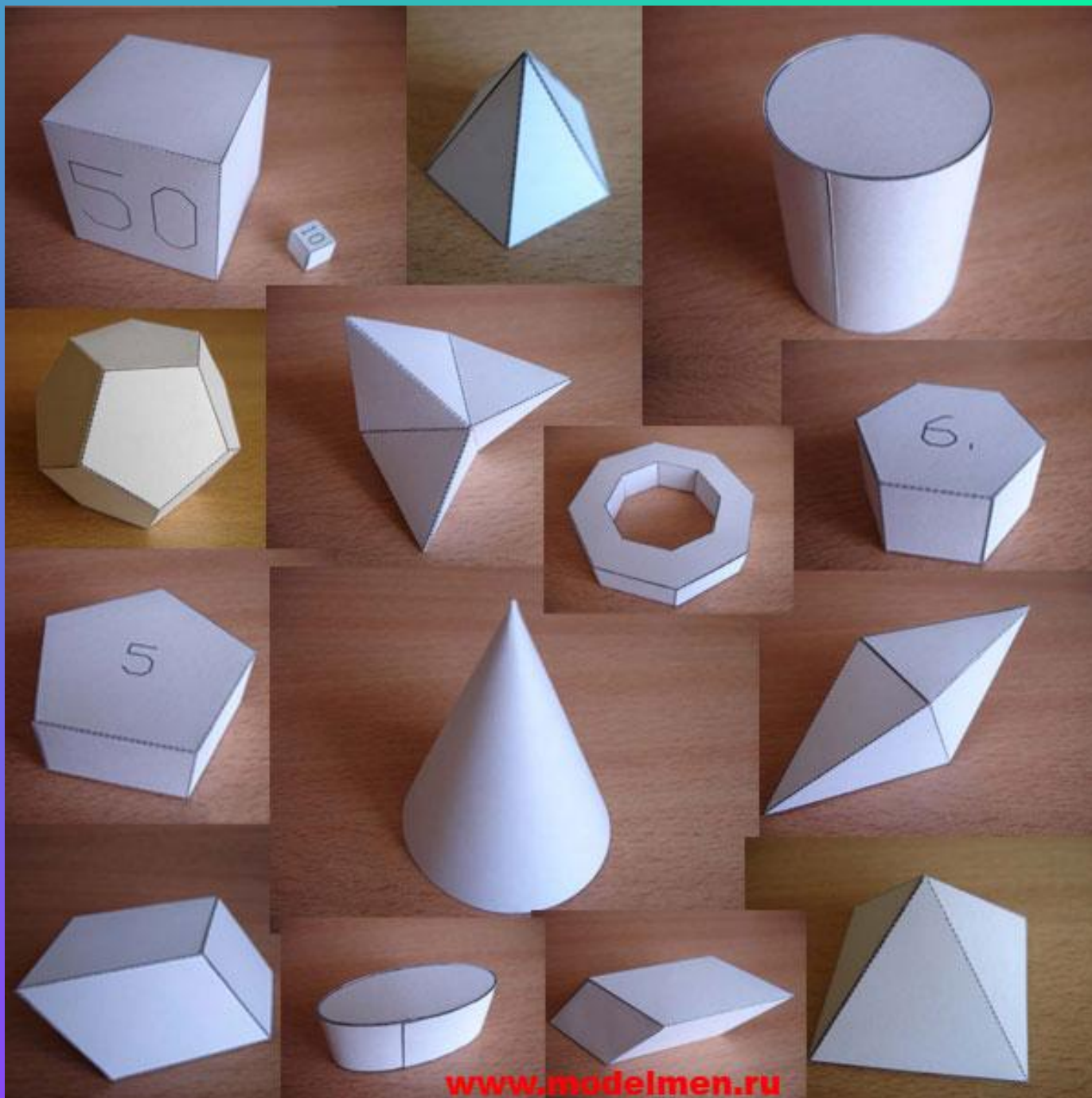

Куб.

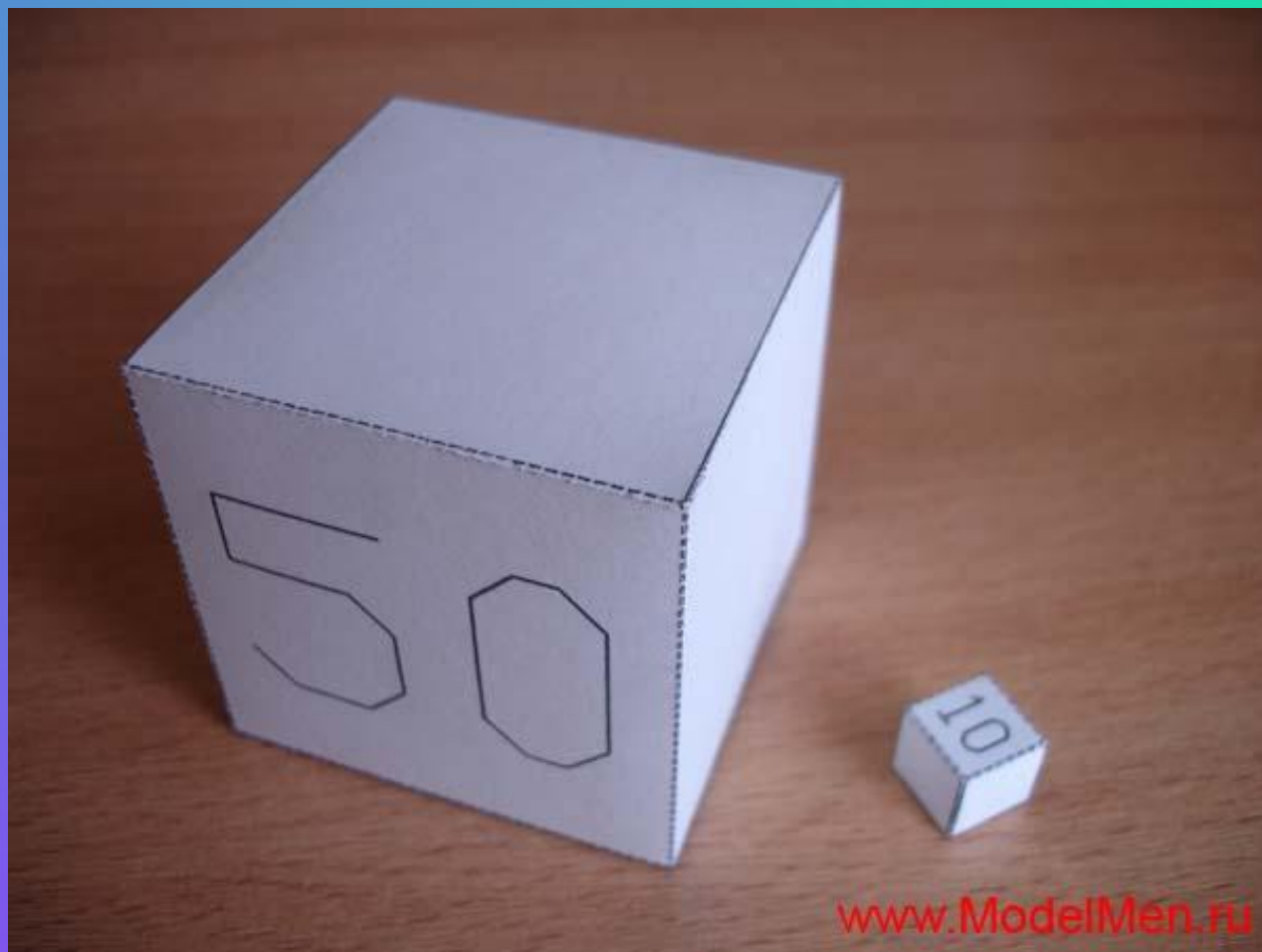

Развертка куба.

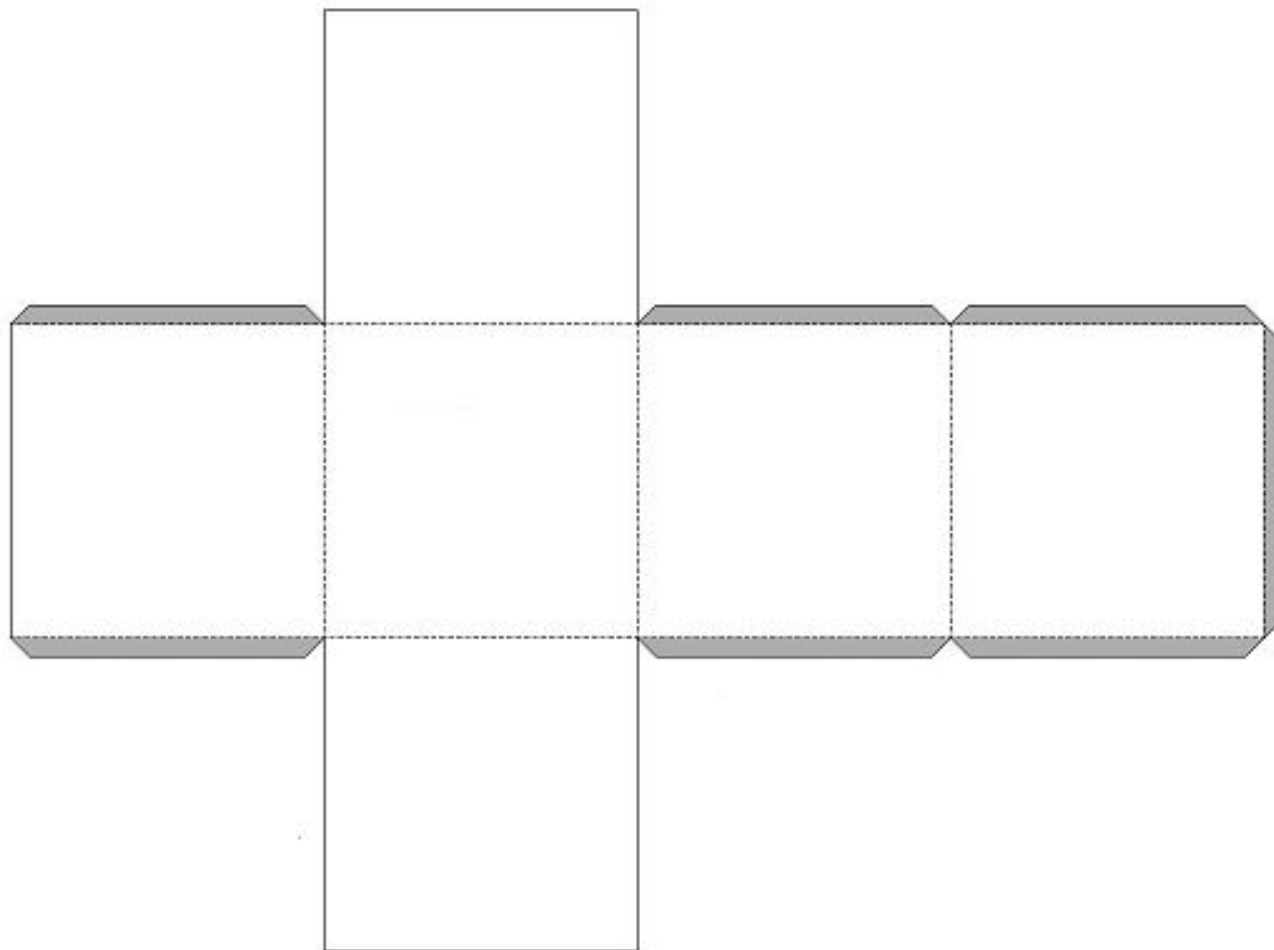

Пирамида.

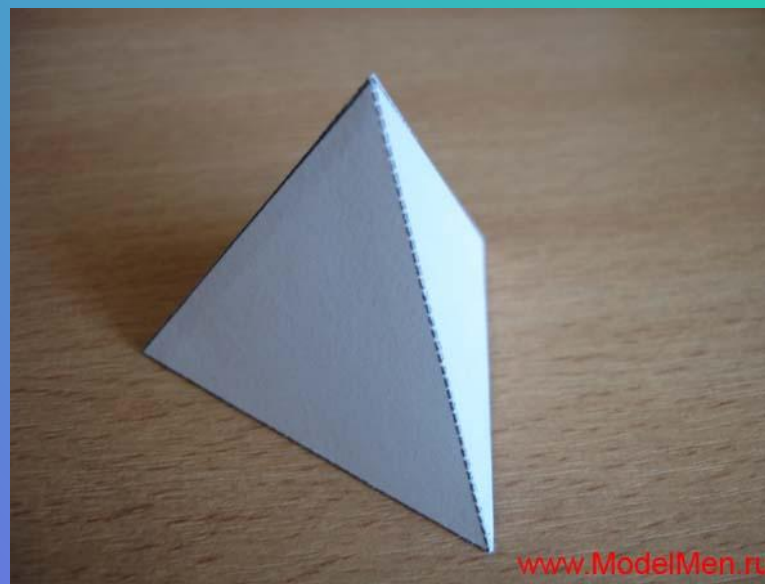
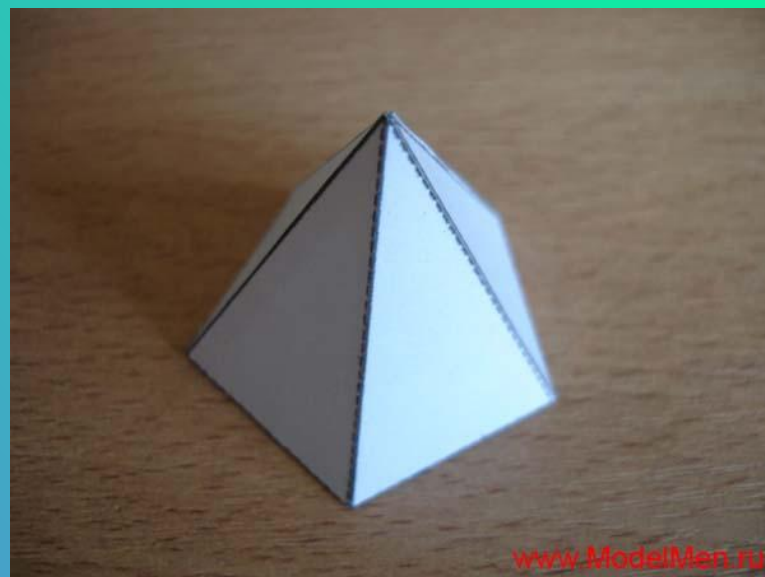
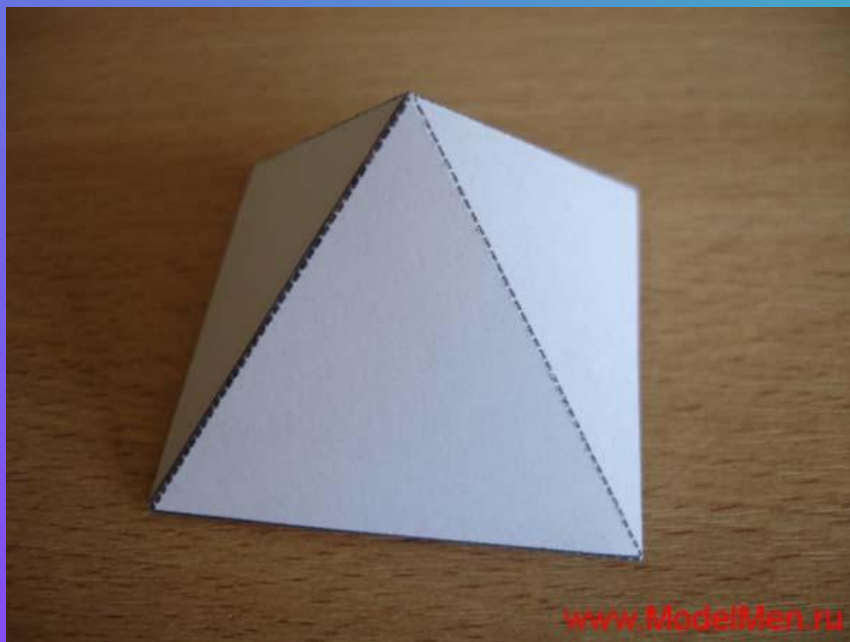

Развертки пирамиды.

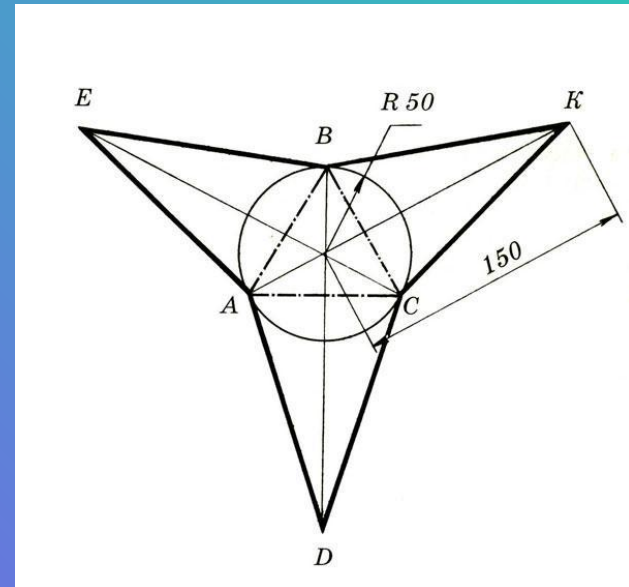
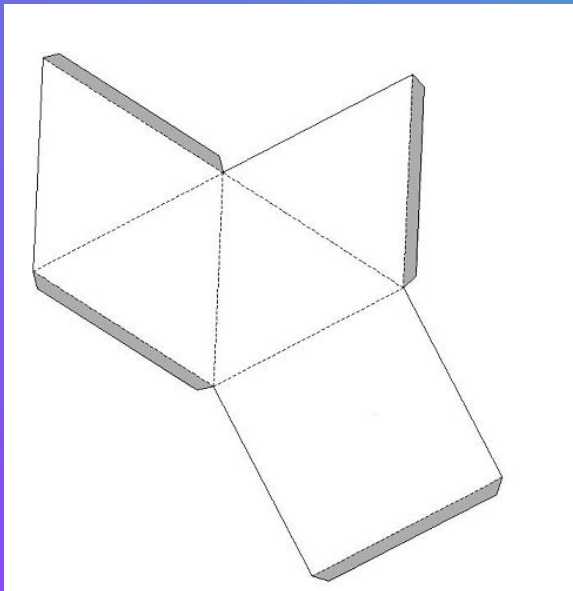
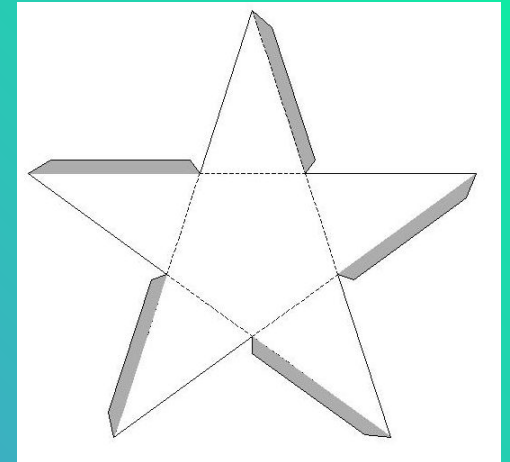
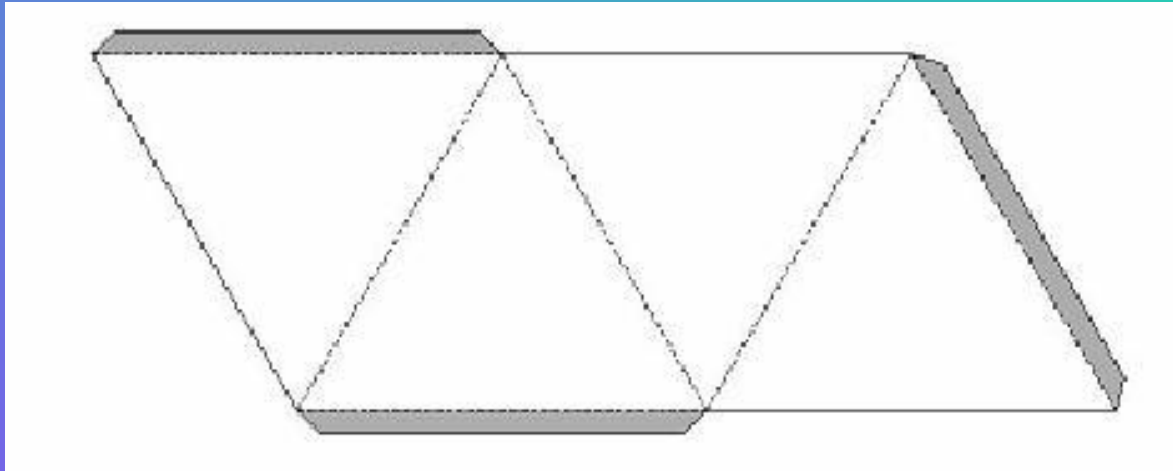

Конус.



Развертка конуса.

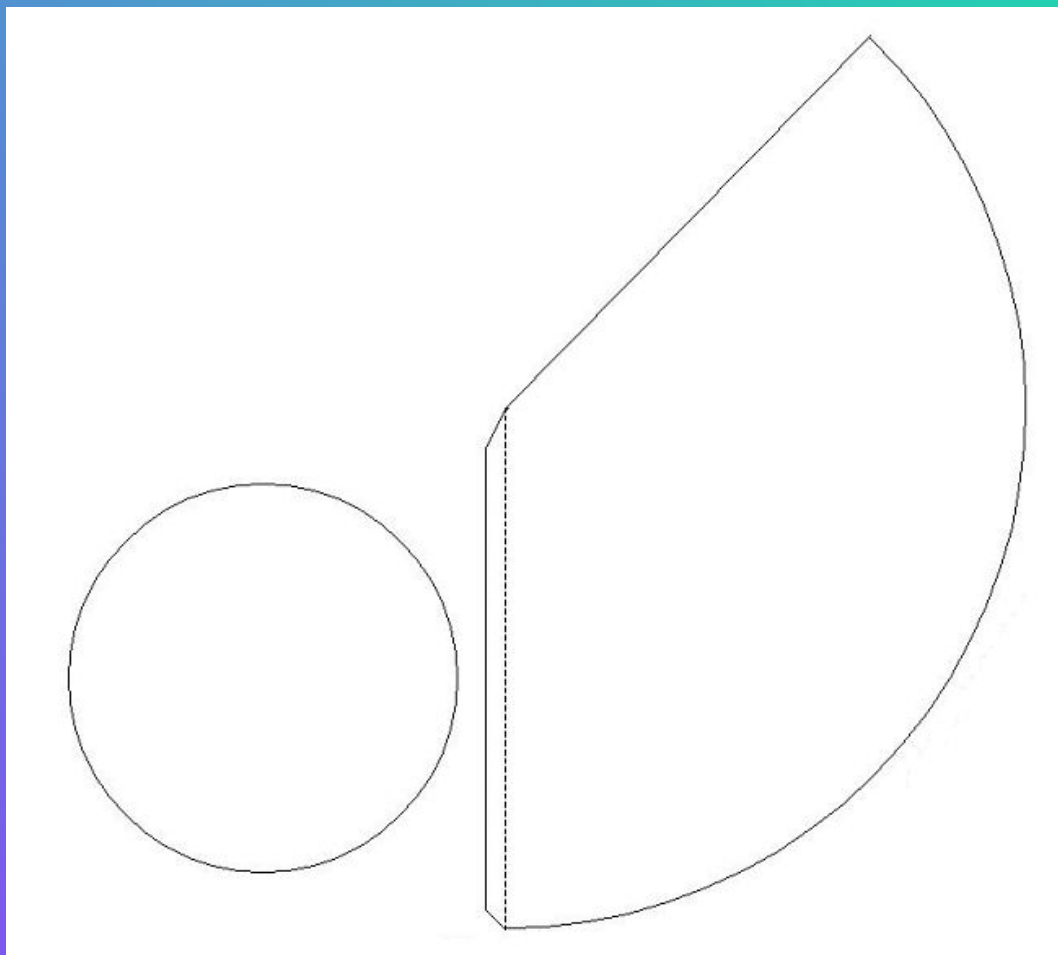

Цилиндр.



Развертка цилиндра.

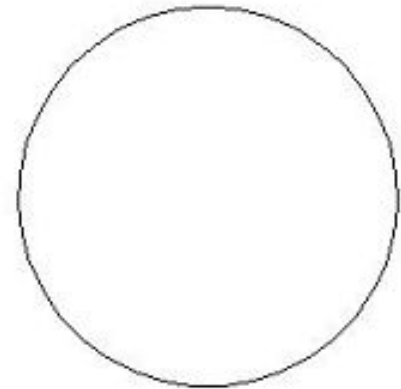
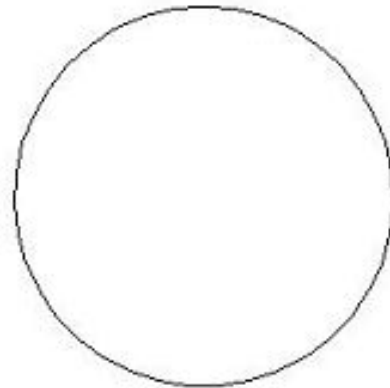

Призма.

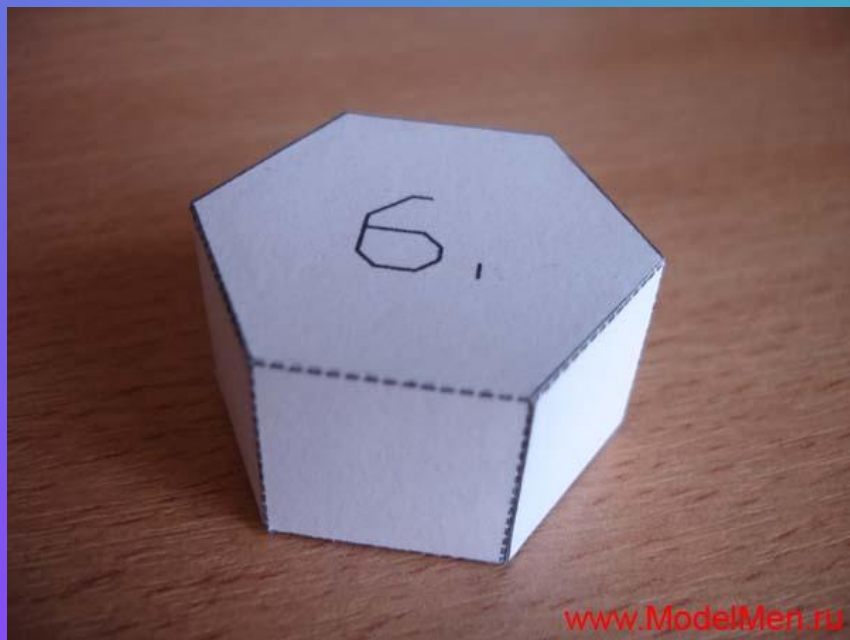

Развертки призм.

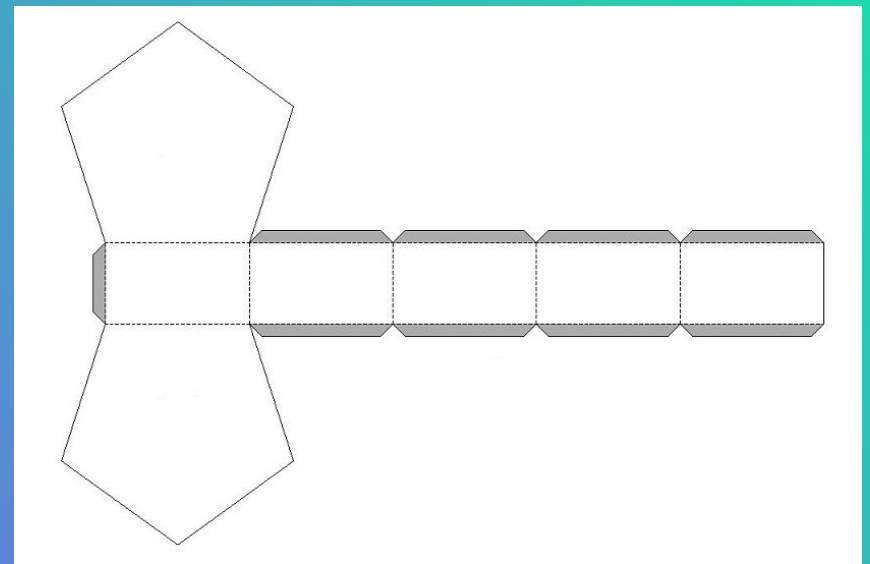
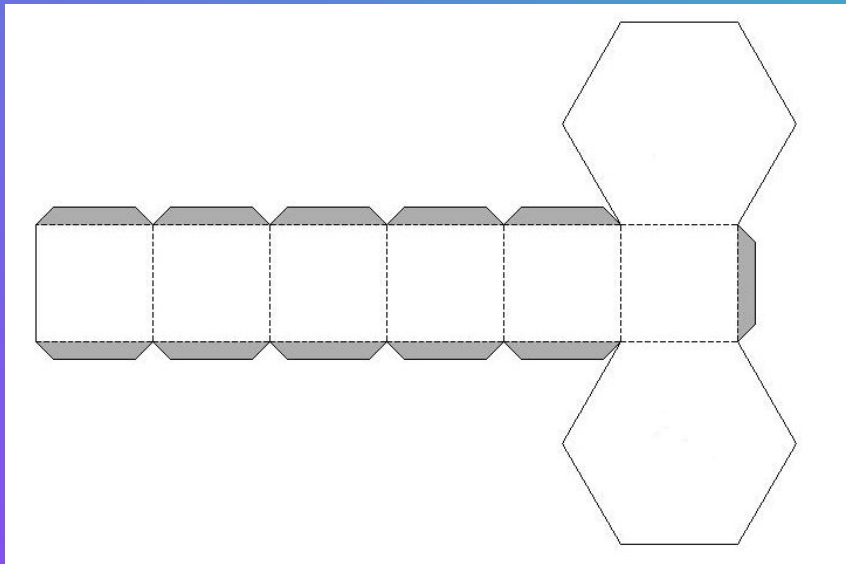

Разные фигуры.

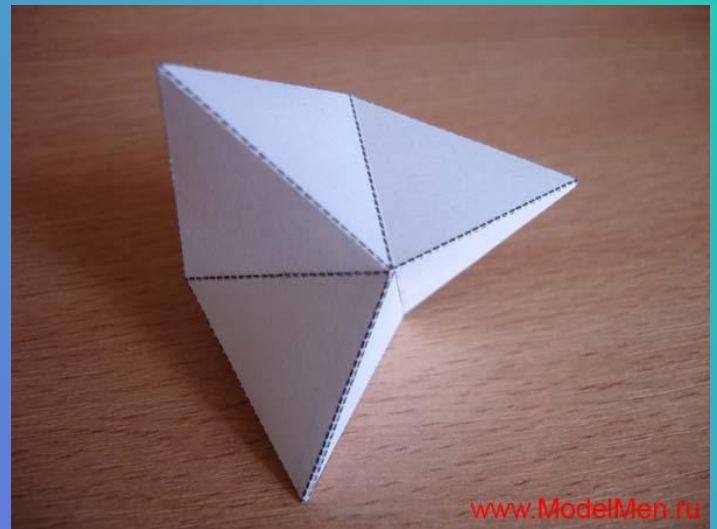
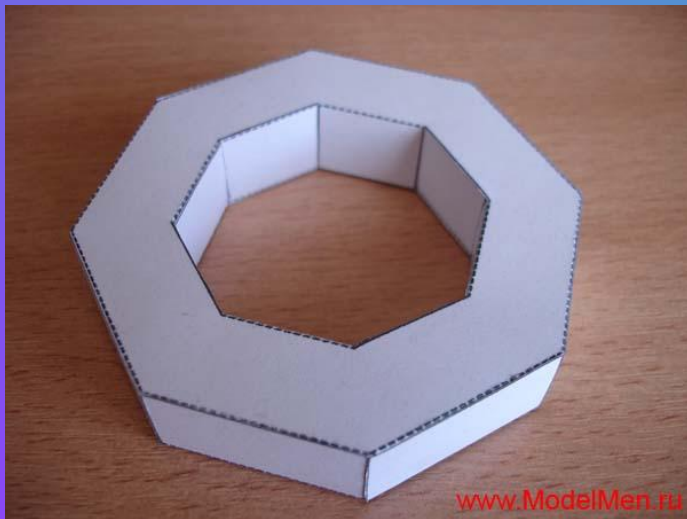
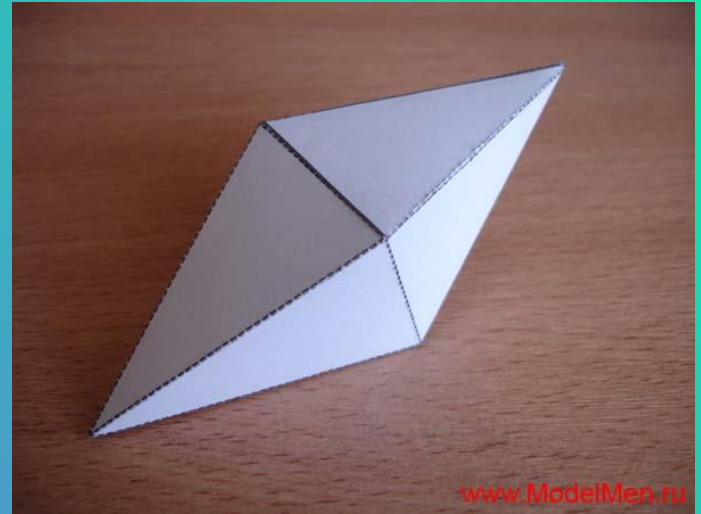
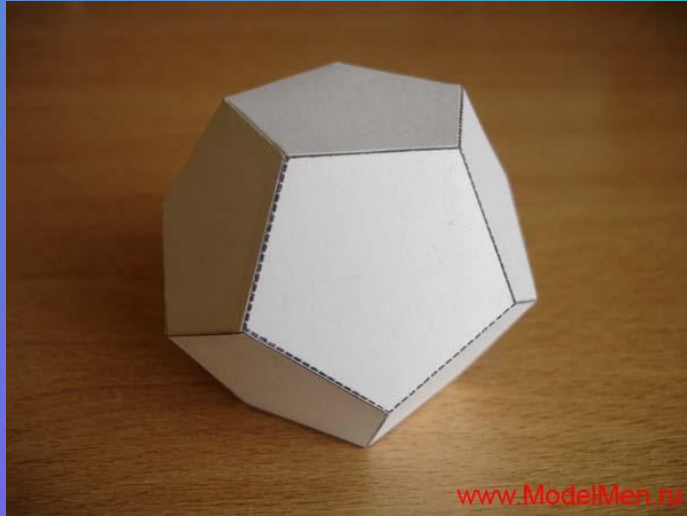

www.modelmen.ru

