В. И. Арнольд

ЦЕПНЫЕ ДРОБИ



—

— — (—)

—

— — —
—

—

— — — — —
— —

—

—

— — —
—

π

π

π

π

π

π

π

π — —

π

—

π ——— ———
———
—————

π

α

α

α —

α

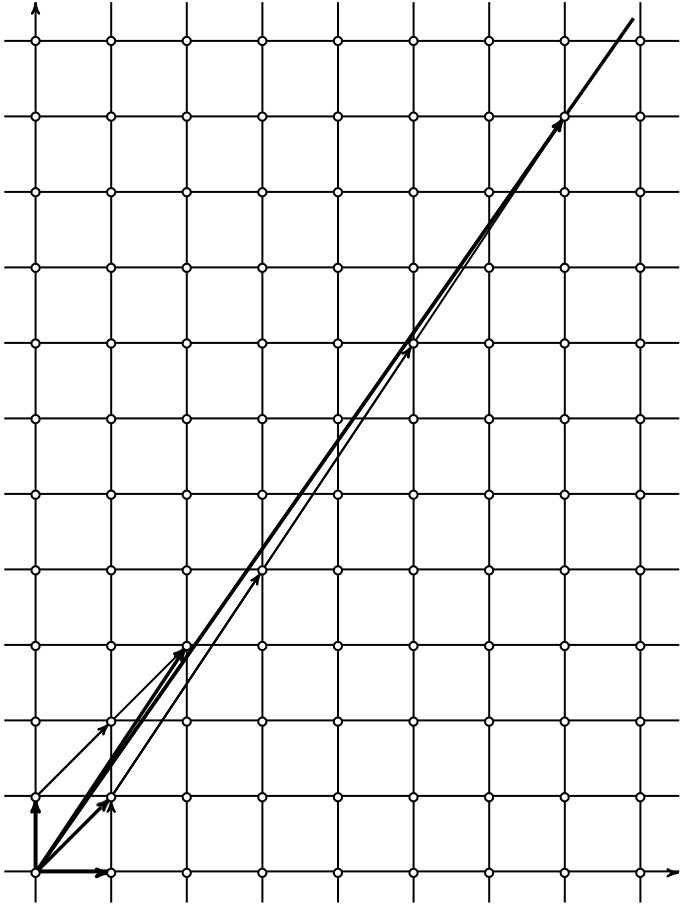

— — —
— — —

α

—

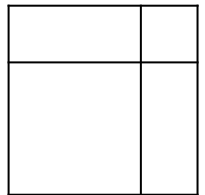
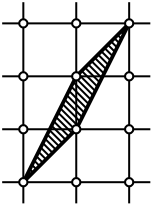

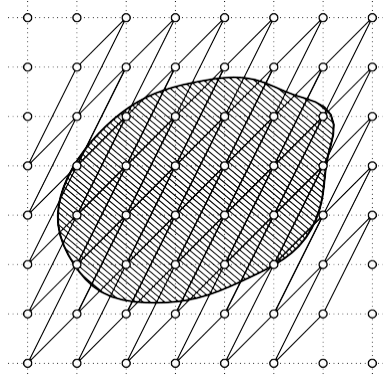

β $\beta\gamma$
 γ

(| |)

()

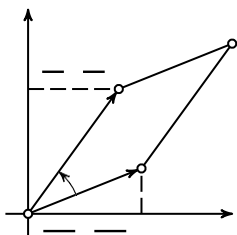

| |

—
 α
 α —
 —

α

$|\alpha$ — | — — |

| — — | ————— —

$|\alpha$ — | — — —

α — — —

—

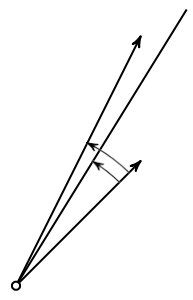

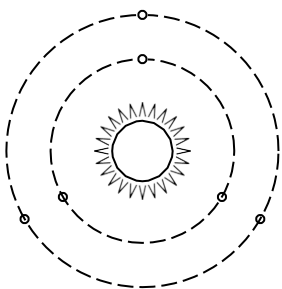

α

α

α

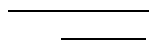

α

— (—)

(—

— —

—

— - (-) - —

—
—

-

—
—

—
—

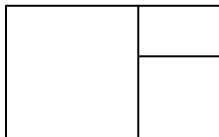
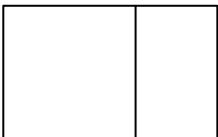

[-]

- [-] {-}

-

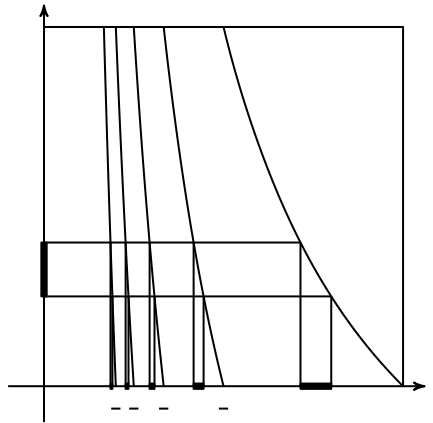
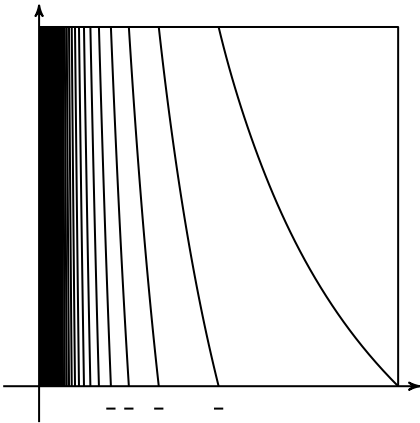

- {-}

(— -)

I

ρ

μ ρ

μ

μ μ

ρ — —

(—

ρ —

— — —

— - — - -

- - - - -

- - - -

ρ

- - - -

(— —)

—————

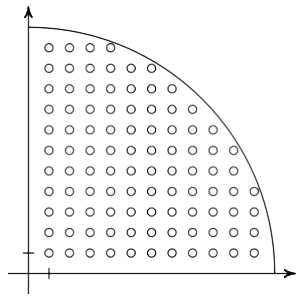

α -

|

-

-

| |

| |

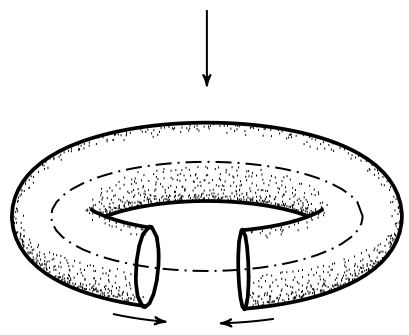
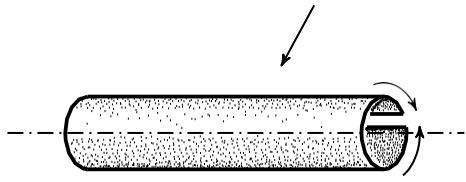
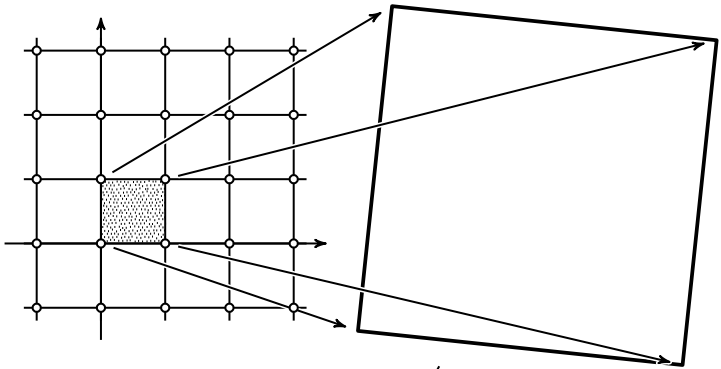

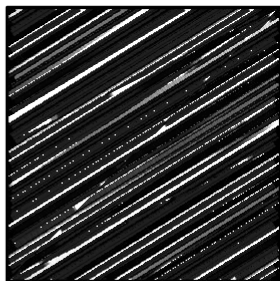
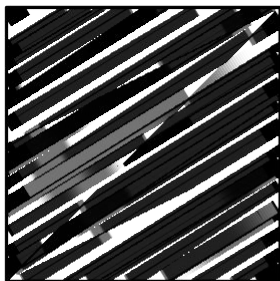
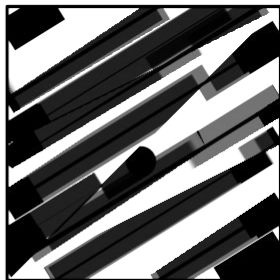
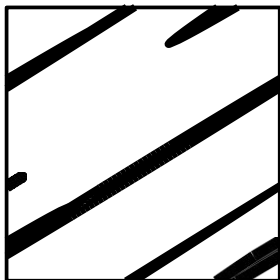
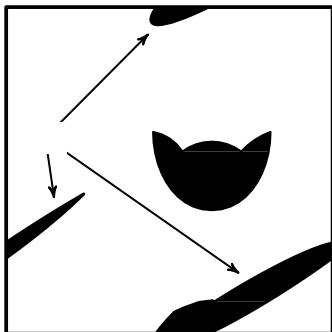
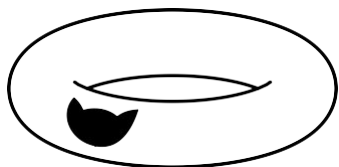



α

α

α



π

—

ζ

ζ

ζ



ζ

π

α

α

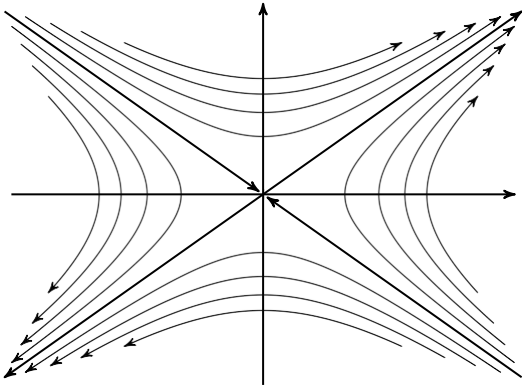

()

α

α

()

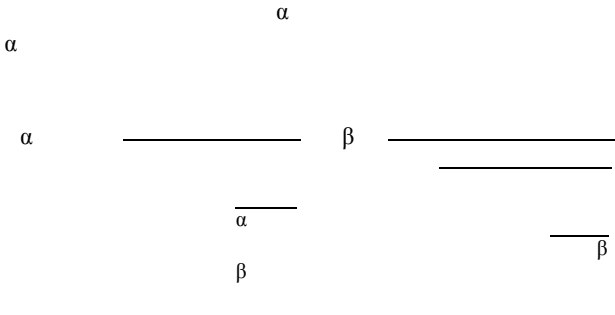

$$\beta \frac{\beta}{\beta} \left(\beta \frac{\beta}{\beta} \beta \frac{\beta}{\beta} \right) \beta$$

α λ α

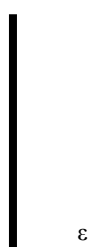
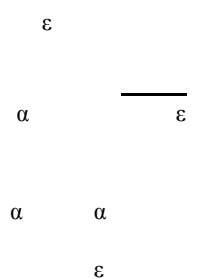
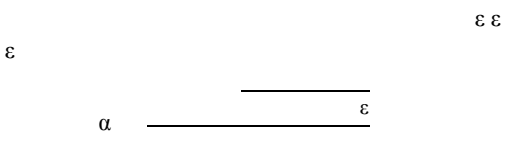
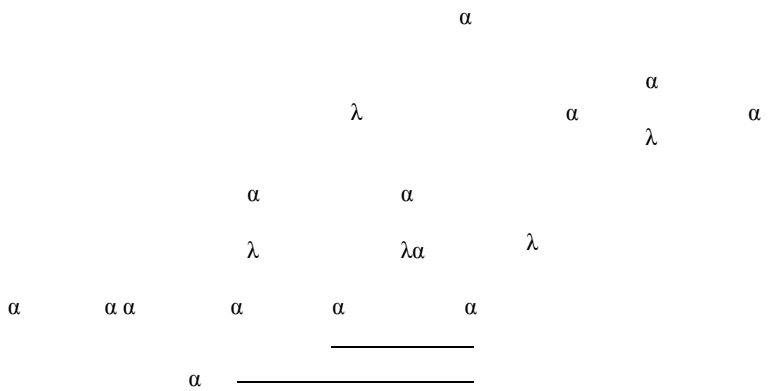

α

α

α

α

α

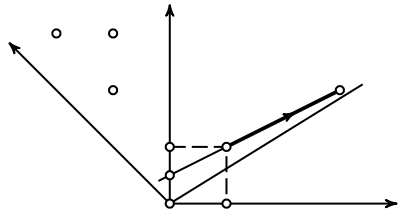
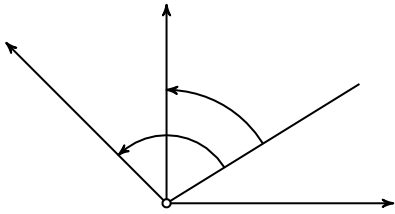

α

α

α

α

α

α

α
 α

α $\frac{\alpha}{\alpha}$

α

α

α

α

α

α $\frac{\alpha}{\alpha}$



α

α

α

α



—

—

—

—

—

—

α

α

α

α

α

α

α

$$\alpha \frac{\alpha}{\alpha}$$

$$\alpha \frac{\quad}{\quad} \varepsilon \quad \varepsilon$$

$\frac{\quad}{\quad}$

$$\frac{\quad}{\alpha} \quad \frac{\quad}{\quad}$$

$$\alpha \quad \frac{\quad}{\alpha}$$

$\alpha \quad \frac{\quad}{\quad}$

α

$$\frac{\quad}{\quad}$$

$\frac{\quad}{\quad}$

$$\frac{\quad}{\quad}$$

$$\frac{\quad}{\quad}$$

ε

α

α

$$\frac{\quad}{\quad}$$

ε

α

α

ε

α

α

ε

α

α

ε

α

α

ε

α

α

ε

α

α

ε

ε

|

α

()

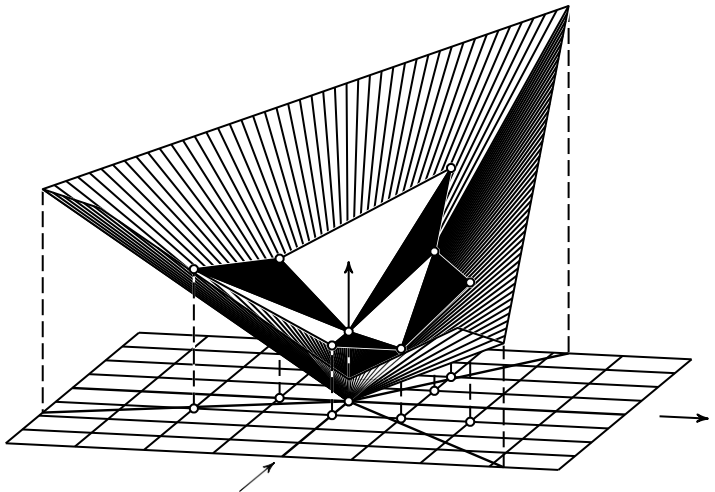
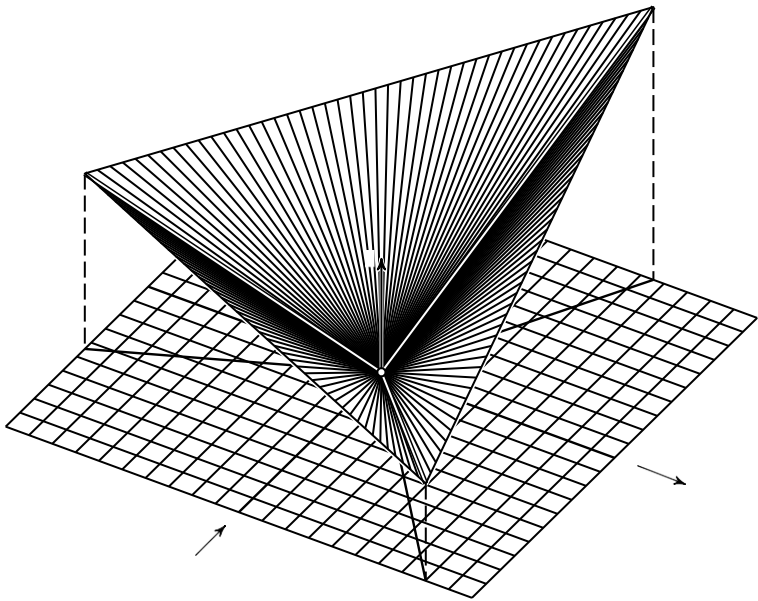

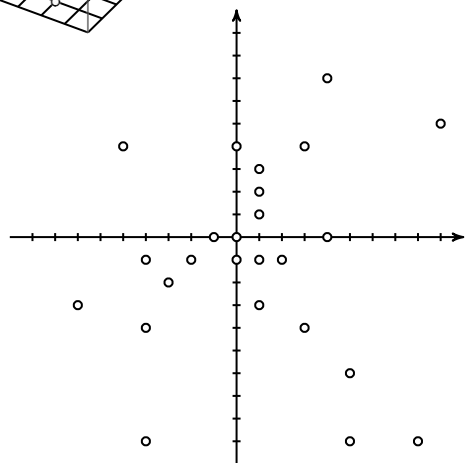
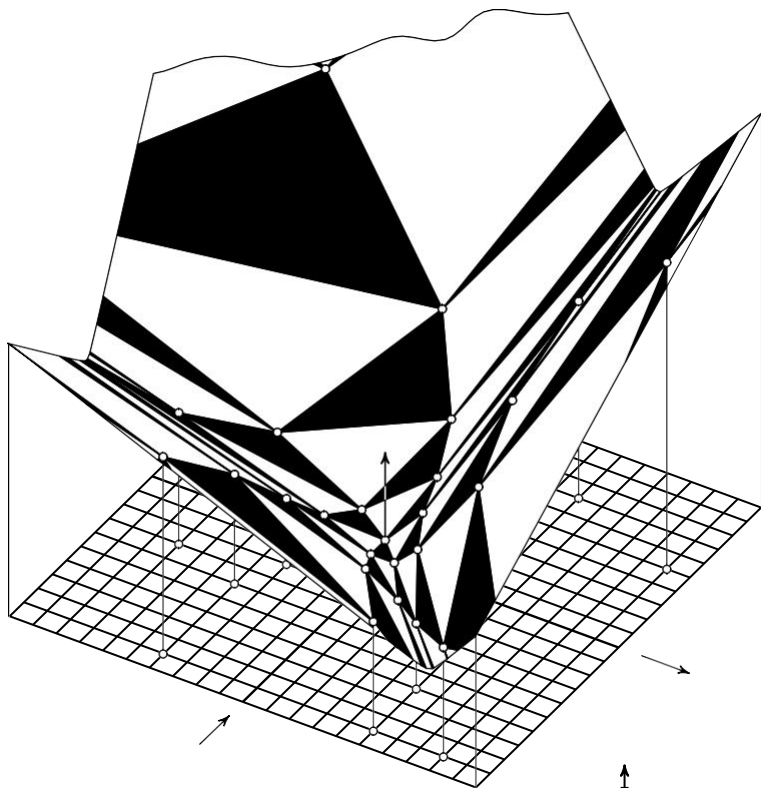

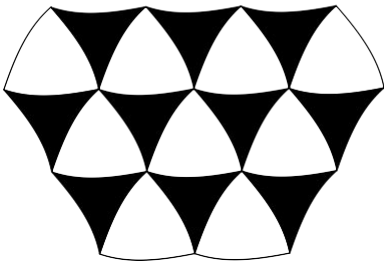
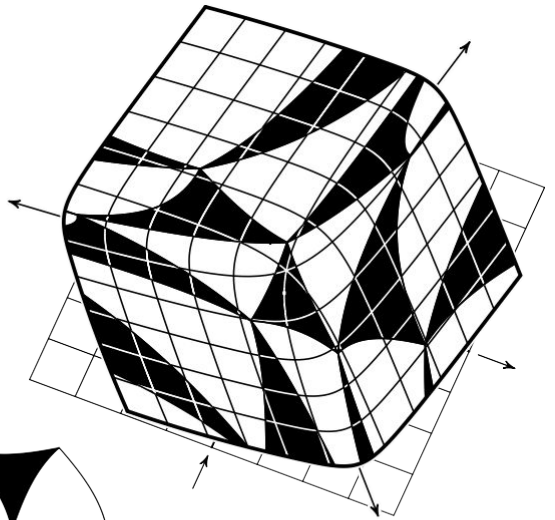
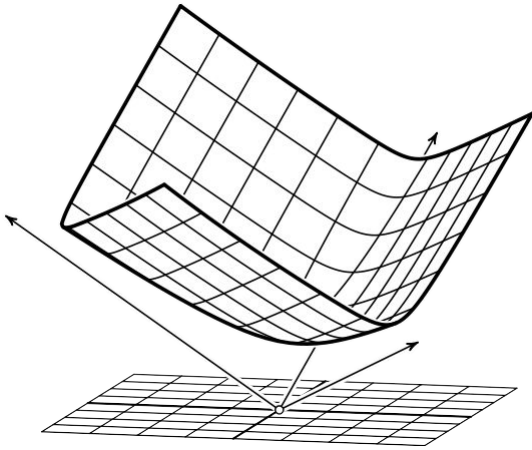

—

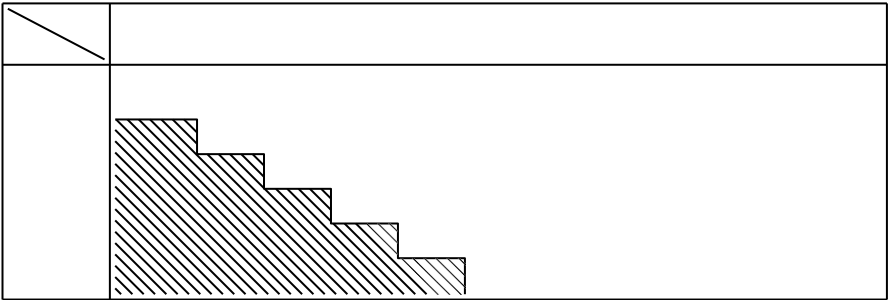

—

- _____

- -

=====

