

Мікропроцесорна техніка

(лекція 7)
Благітко Б.Я.
2019 р.

PSoC Creator 4.2
Designing with PSoC 3/5



PSoC@3/5 Fan Controller

PSoC Creator 4.2
Designing with PSoC 3/5



PSoC@3/5

Управління
швидкістю обертання ротора
двигунів постійного струму

PSoC Creator 4.2
Designing with PSoC 3/5



Figure 1-1. Simplified Block Diagram

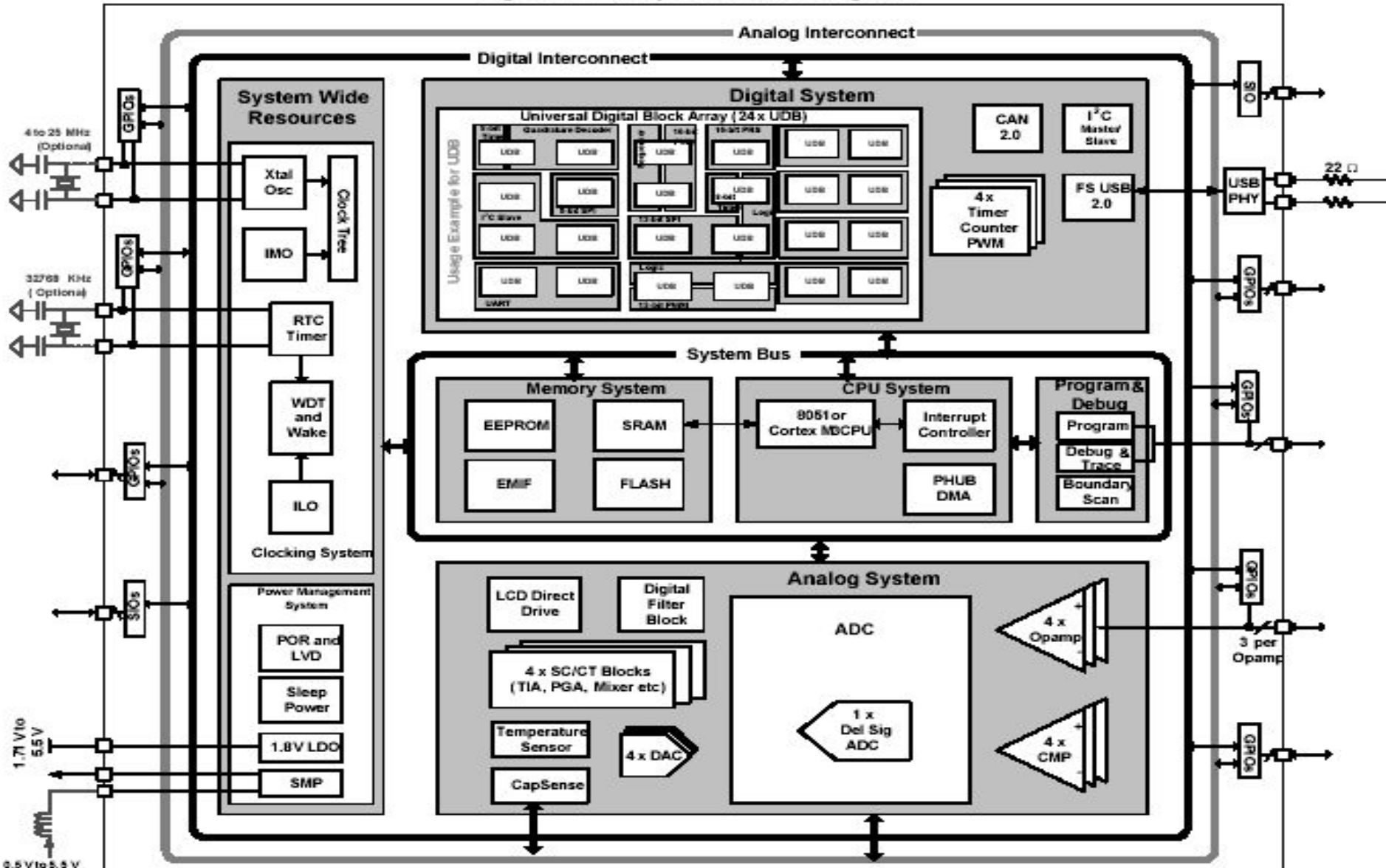

Figure 7-3. Component Catalog

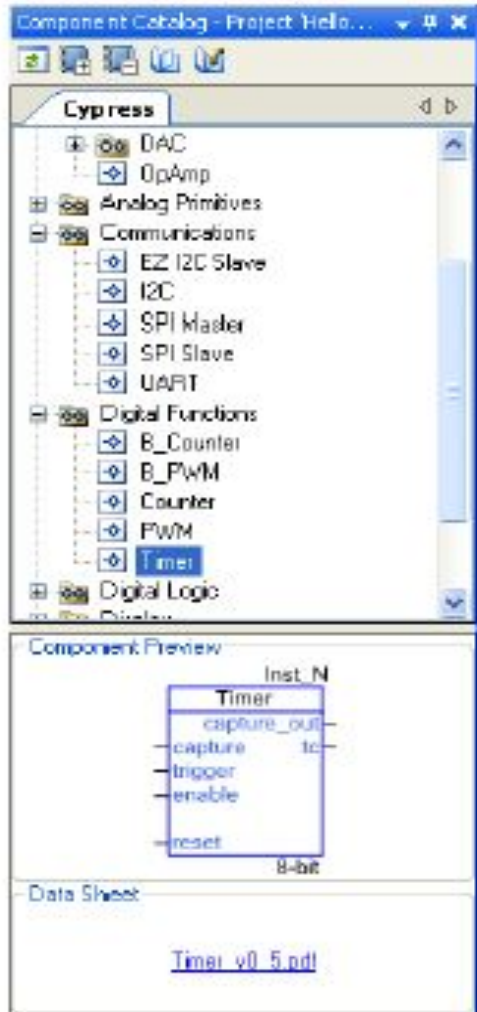
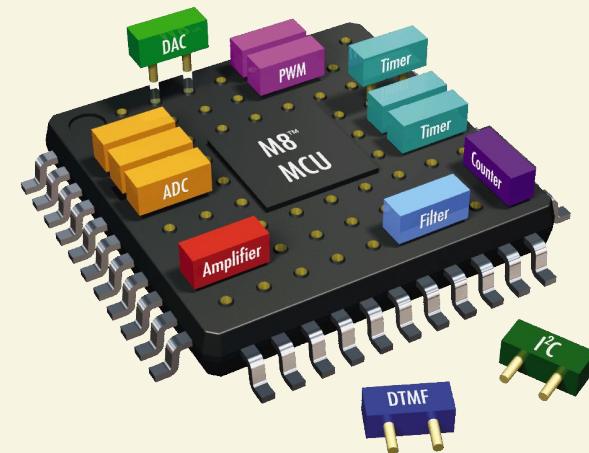
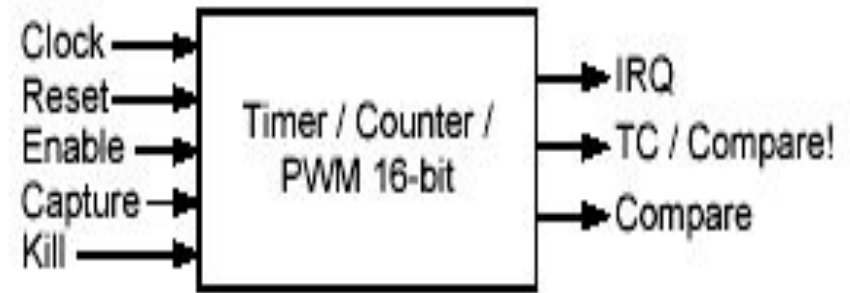

Figure 7-21. Timer/Counter/PWM





PWMs and **Counters** share many capabilities but each provides specific capabilities.

When to Use a PWM

The most common use of the **PWM** is to generate periodic waveforms with adjustable duty cycles. The PWM also provides optimized features for power control, motor control, switching regulators and lighting control. The PWM can also be used as a clock divider by driving a clock into the clock input and using the terminal count or a PWM output as the divided clock output.

When to Use a Counter

A **Counter** component is better used in situations that require the counting of a number of events but also provides rising edge capture input as well as a compare output.

PWM

Output	May Be Hidden	Description
tc	N	The terminal count output is '1' when the period counter is equal to zero. In normal operation this output will be '1' for a single cycle where the counter is reloaded with period. If the PWM is stopped with the period counter equal to zero then this signal will remain high until the period counter is no longer zero. This output is synchronized to the block clock input of the component.
interrupt	Y	The interrupt output is the logical OR of the group of possible interrupt sources. This signal will go high while any of the enabled interrupt sources are true. The interrupt output shall remain asserted until the Status Register is read out by the software. In order to receive subsequent interrupts, the interrupt shall be cleared by reading the Status Register using the PWM_ReadStatusRegister() API. The interrupt output is not visible if the Use Interrupt parameter is not set. This allows the status register to be removed for resource optimization as necessary.
pwm/pwm1	Y	The pwm or pwm1 output is the first or only pulse width modulated output. This signal is defined by PWM Mode, compare modes(s), and compare value(s) as indicated in waveforms in the Configure dialog. When the instance is configured in one output, Dual Edged, Hardware Select, Center Aligned, or Dither PWM Modes, then the output "pwm" is visible. Otherwise the output "pwm1" is visible with "pwm2" the other pulse width signal. This output is synchronized to the block clock input of the component.

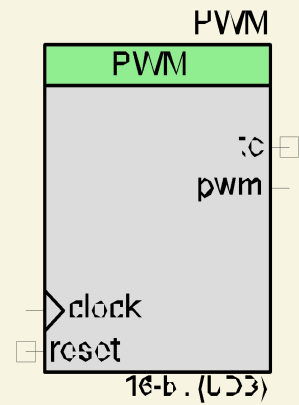
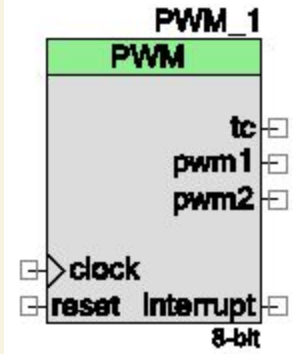
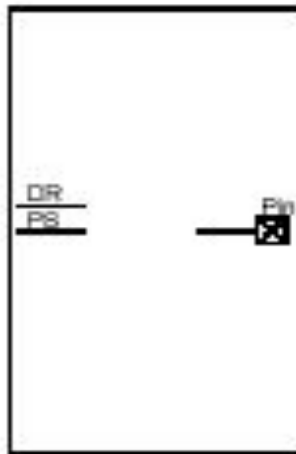
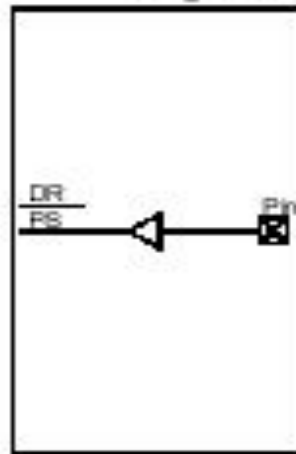

Figure 6-11. Drive Mode



0. High Impedance Analog



1. High Impedance Digital

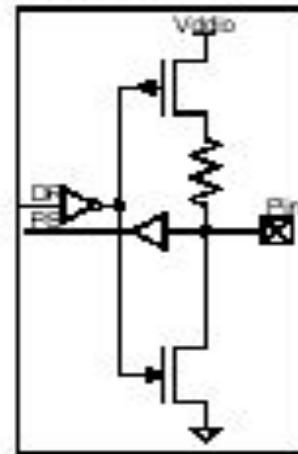

2. Resistive Pull-Up

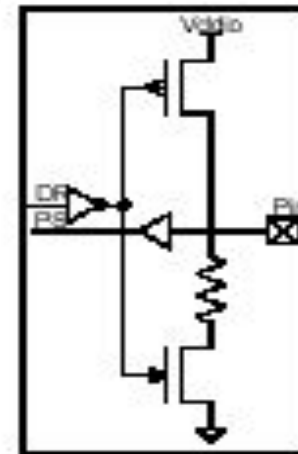

3. Resistive Pull-Down

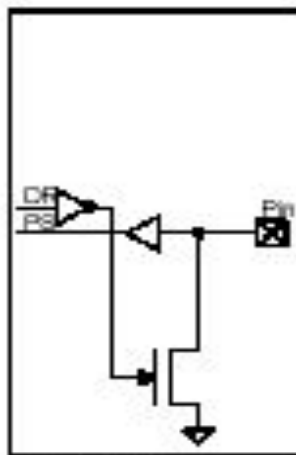

4. Open Drain Drives Low

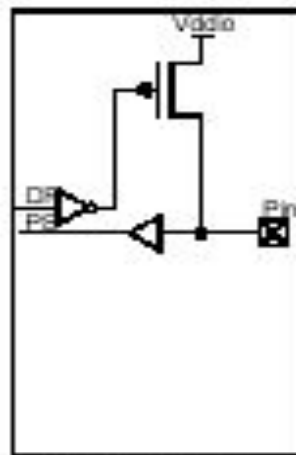

5. Open Drain Drives High

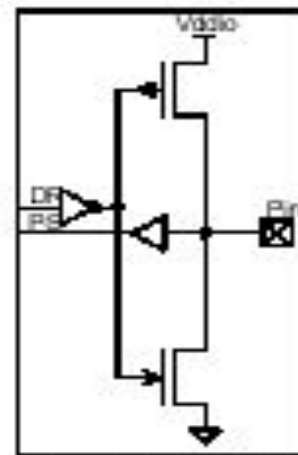

6. Strong Drive

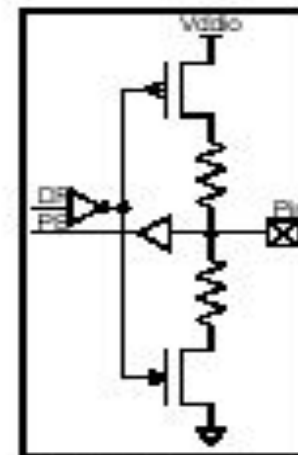

7. Resistive Pull-Up and Pull-Down

A DC motor uses a commutator to supply continuous direct current to a coil placed between two or more magnets.

A stepper motor receives pulses of electricity from a pulse generator and sends them through a similar coil-magnet setup.

In both cases, the Oersted effect causes the coils to turn the motor's shaft.

Read more: [DC Motor vs. Stepper Motor | eHow.com](http://www.ehow.com/facts_6777501_dc-motor-vs_-stepper-motor.html#ixzz2QKmmwrgy) http://www.ehow.com/facts_6777501_dc-motor-vs_-stepper-motor.html#ixzz2QKmmwrgy



When to Use a Fan Controller

Use the Fan Controller component when you want to provide your application with device.

Lab_2 - PSoC Creator 2.1 [D:\PSoc_3\Lab_2\Lab_2.cydsn\TopDesign\TopDesign.cysch]

File Edit View Debug Project Build Tools Window Help

Microsoft Sans Serif 10 B I U

Workspace Explorer

- Workspace 'Lab_2' (1 Projects)
 - Project 'Lab_2' [CY8C3866]
 - TopDesign.cysch
 - Lab_2.cydwr
 - Header Files
 - device.h
 - Source Files
 - main.c

Start Page *TopDesign.cysch

Component Catalog (174 co...)

Configuration Concept Cypress

- Analog MUX
 - Comparator [v1.90]
 - DAC
 - Manual Routing
 - Mixer [v1.91]
 - Sample/Track and Hold
 - VRef [v1.60]
- CapSense
- Communications
- Digital
 - Functions
 - Counter [v2.20]
 - CRC [v2.20]
 - Debouncer
 - Glitch Filter [v2.0]
 - PrISM [v2.10]
 - PRS [v2.10]
 - PWM [v2.20]
 - Quadrature Decode
 - Shift Register [v2.10]
 - Timer [v2.30]
 - Logic

Configure 'PWM'

Name: PWM

Configure Advanced Built-in

period: 255 0 255 0

pwm1

pwm2

Implementation: Fixed Function UDB

Resolution: 8-Bit 16-Bit

PWM Mode: Two Outputs

Period: 255 Max *Period = UNKNOWN SOURCE FREQ*

CMP Value 1: 127 CMP Value 2: 63

Datasheet OK Apply Cancel

Page 1

Output

Show output from: All

Log file for this session is located at: C:\Documents and Settings\Admin

Notice List

2 Errors 0 Warnings

De... File

Component Preview

Datasheet

8 or 16-bit Pulse Width Modulator

Ready

2 Errors 0 Warnings 0 Notes

EN 6:53

FanController

Компонента надає низькорівневий драйвер для управління швидкістю обертання ротора двигунів постійного струму . Крім того, ця компонента забезпечує для користувача налаштовувач, який полегшує налаштування дескрипторів

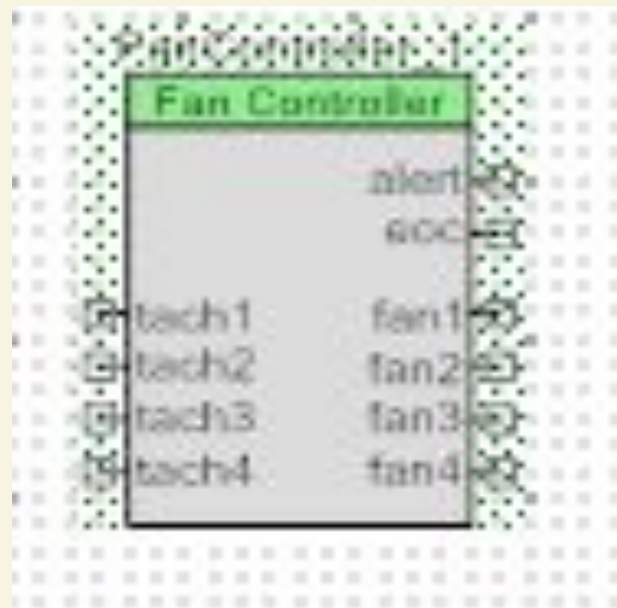

Компонента в PSoC Creator 4.2, яка працює з Fan

- Fan Controller

Ця компонента знаходиться
в компонент каталозі,
в категорії
"Thermal Management".

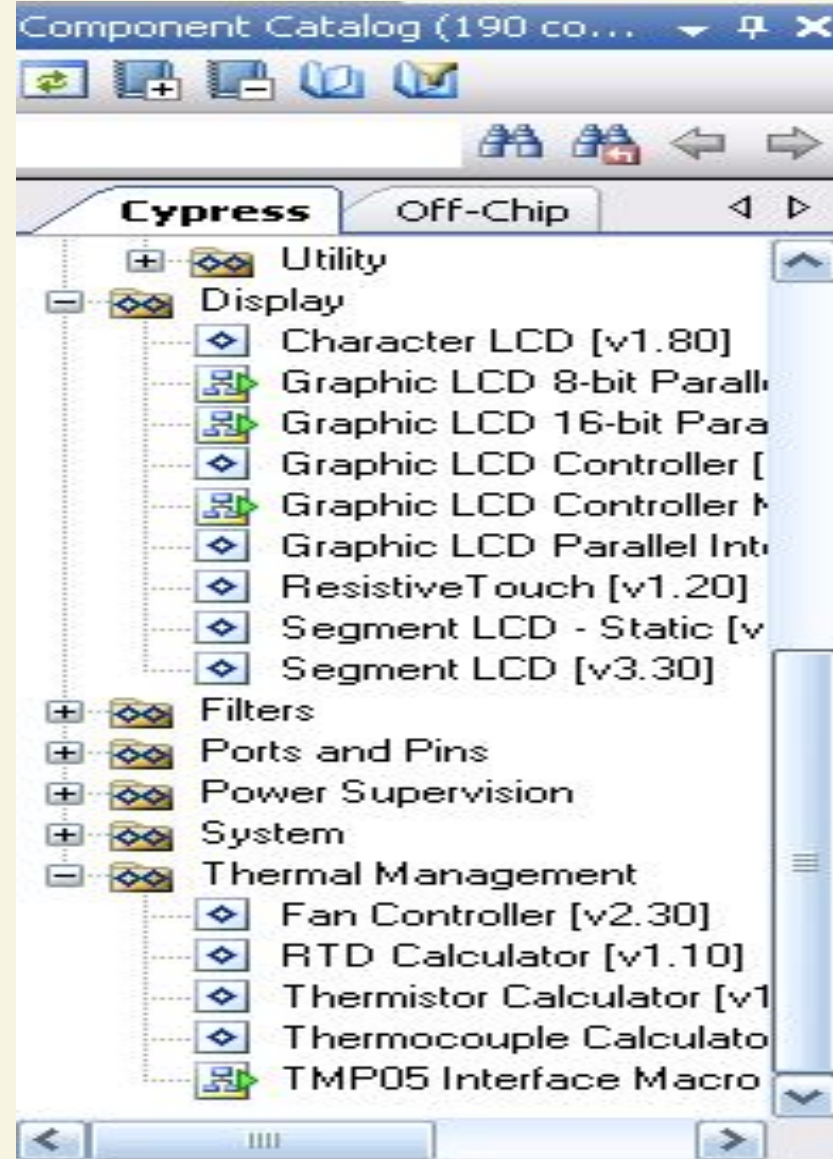

Empty PSoC 3/5 Design

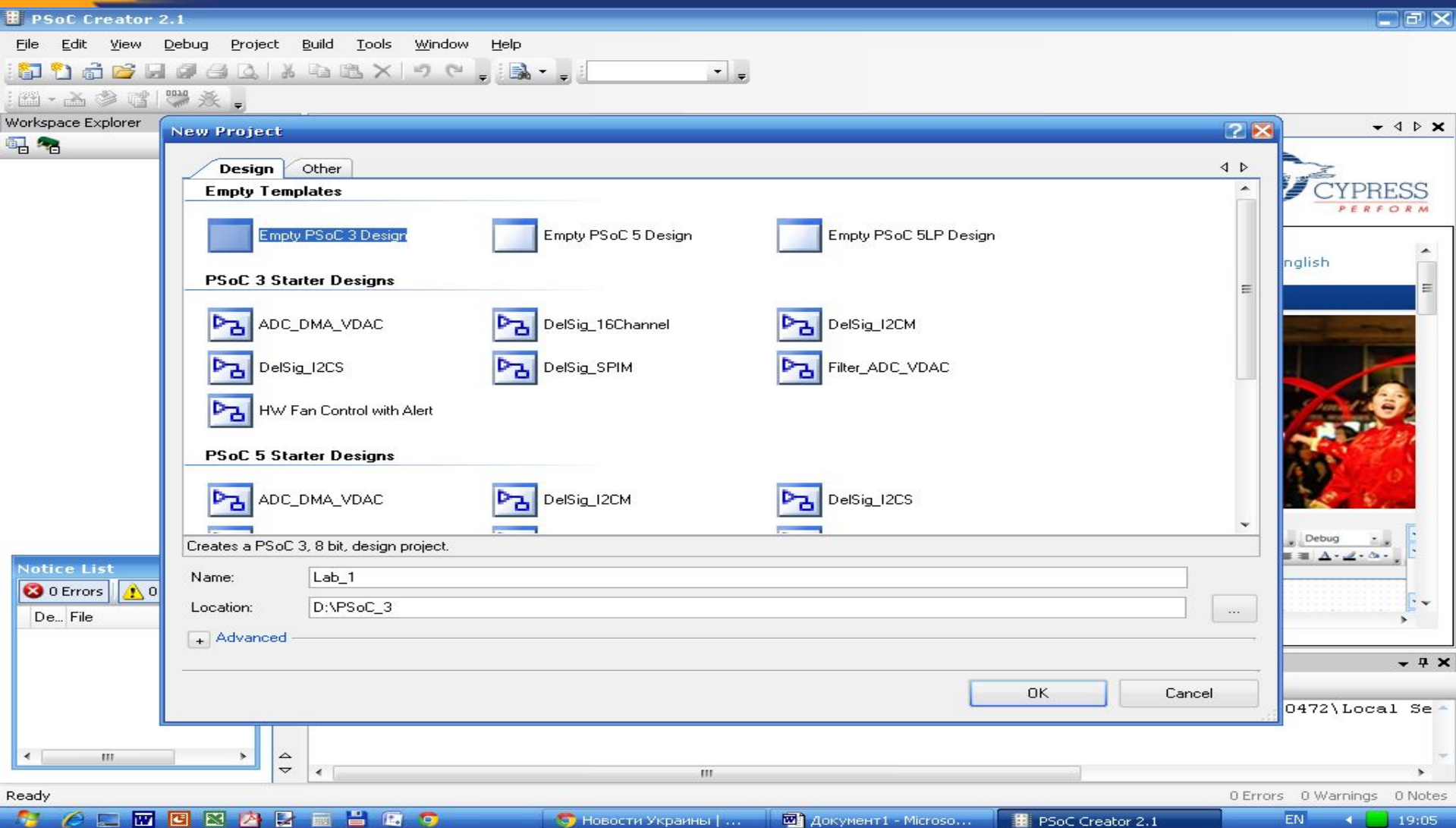

PSoC Creator 2.1

File Edit View Debug Project Build Tools Window Help

Workspace Explorer

New Project

Design Other

Empty Templates

- Empty PSoC 3 Design
- Empty PSoC 5 Design
- Empty PSoC 5LP Design

PSoC 3 Starter Designs

- ADC_DMA_VDAC
- DelSig_I2CS
- HW Fan Control with Alert
- DelSig_16Channel
- DelSig_SPIM
- DelSig_I2CM
- Filter_ADC_VDAC

PSoC 5 Starter Designs

- ADC_DMA_VDAC
- DelSig_I2CM
- DelSig_I2CS

Creates a PSoC 3, 8 bit, design project.

Name: Lab_1

Location: D:\PSoC_3

+ Advanced

OK Cancel

Notice List

- 0 Errors
- 0 Warnings
- 0 Notes

0472\Local Se

Ready

0 Errors 0 Warnings 0 Notes

EN 19:05

CHAPTER #LOW



Lab_7 Fan

CharLCD_CustomFont01 - PSoC Creator 2.1 [F:\...\CharLCD_CustomFont01.cydsn\TopDesign\TopDesign.cysch]

File Edit View Debug Project Build Tools Window Help

Microsoft Sans Serif 10 B I U

Workspace Explorer (1 project)

- Workspace 'CharLCD_CustomFont01'
 - Project 'CharLCD_CustomFont01'
 - TopDesign.cysch
 - CharLCD_CustomFont01
 - Header Files
 - device.h
 - Source Files
 - main.c
 - Generated_Source
 - PSoC3
 - cy_boot
 - CyBootAsmk
 - CyDmac.c
 - CyDmac.h
 - CyFlash.c
 - CyFlash.h
 - CyLib.c
 - CyLib.h
 - cymem.a51
 - cypins.h

Start Page TopDesign.cysch CharLCD_Cust...Font01.cydwr main.c

LCD
Character LCD

Component Catalog (174 co...)

- Cypress Component Catalog
 - Analog
 - ADC
 - Amplifiers
 - Analog MUX
 - Comparator [v1.90]
 - DAC
 - Manual Routing
 - Mixer [v1.91]
 - Sample/Track and Hold
 - VRef [v1.60]
 - CapSense
 - Communications
 - Digital
 - Display
 - Character LCD [v1.70]
 - Graphic LCD 8-bit Paralle
 - Graphic LCD 16-bit Paralle
 - Graphic LCD Controller I
 - Graphic LCD Parallel Int
 - Resistive Touch [v1.10]

Notice List

0 Errors 0 Warnings

De... File Error L

Output

Show output from: All

Log file for this session is located at: C:\Documents and Settings\Admin

Page 1

Component Preview

Datasheet

Configure LCD

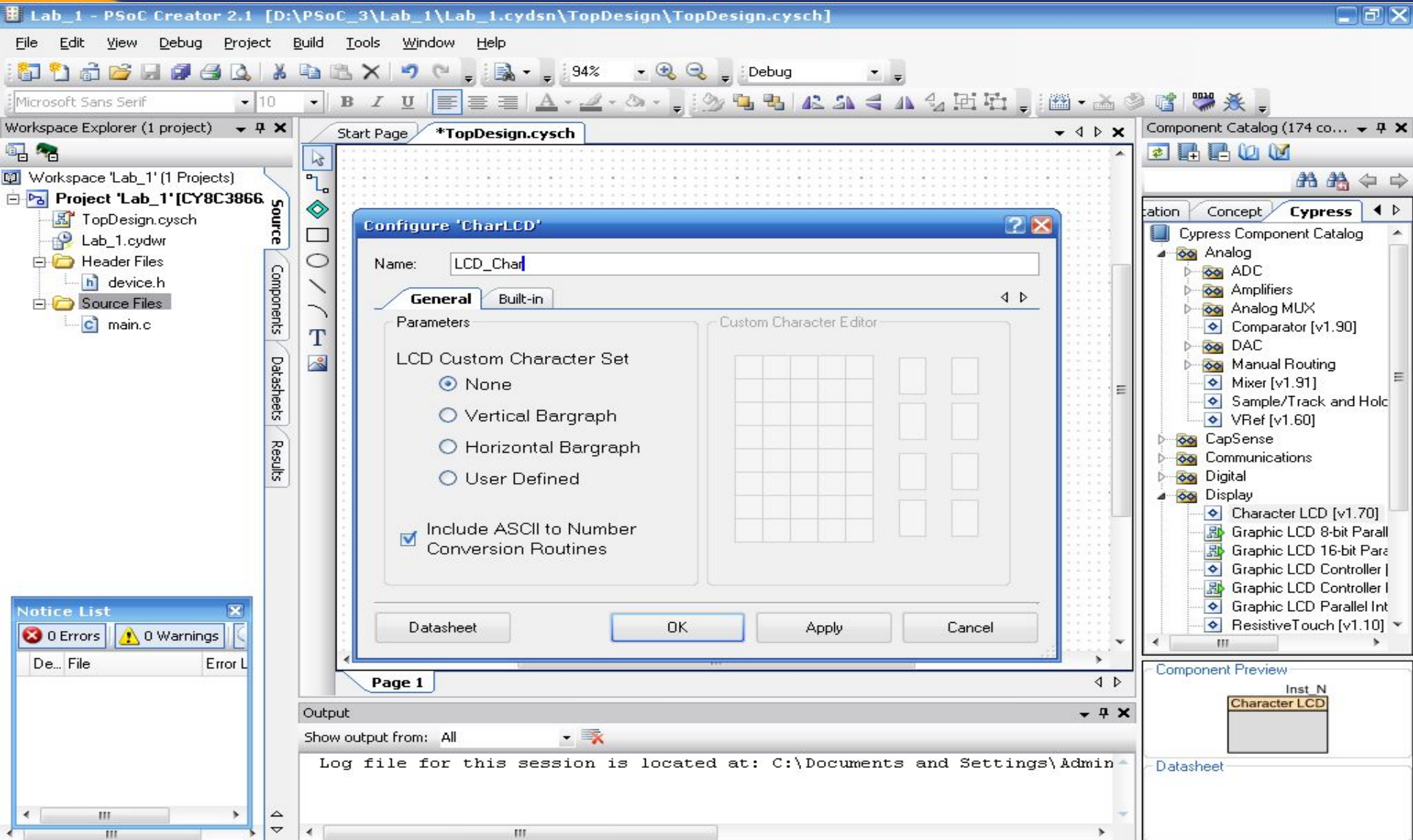

The screenshot shows the PSoC Creator 2.1 software interface. The main window displays the 'Configure CharLCD' dialog box for a component named 'LCD_Char'. The dialog has two tabs: 'General' and 'Built-in'. Under the 'General' tab, there are two sections: 'Parameters' and 'Custom Character Editor'. In the 'Parameters' section, the 'LCD Custom Character Set' is set to 'None'. Other options include 'Vertical Bargraph', 'Horizontal Bargraph', and 'User Defined'. The 'Include ASCII to Number Conversion Routines' checkbox is checked. The 'Custom Character Editor' section contains a grid for defining characters. At the bottom of the dialog are buttons for 'Datasheet', 'OK', 'Apply', and 'Cancel'. The background shows the workspace explorer with project files, a component catalog on the right, and a notice list at the bottom left.

Start Page

TopDesign.cysch

Dvyhun.cydwr

main.c

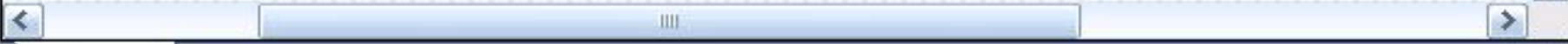
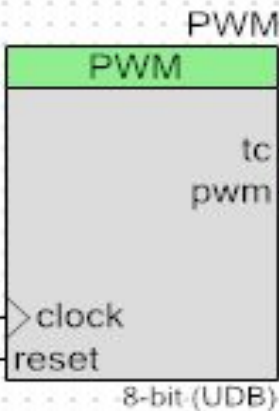
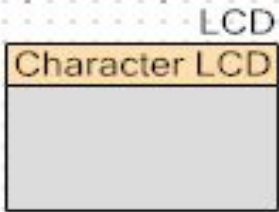
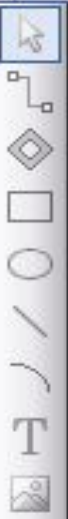
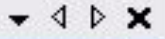

Configure 'PWM'

Name:

Configure | Advanced | Built-in

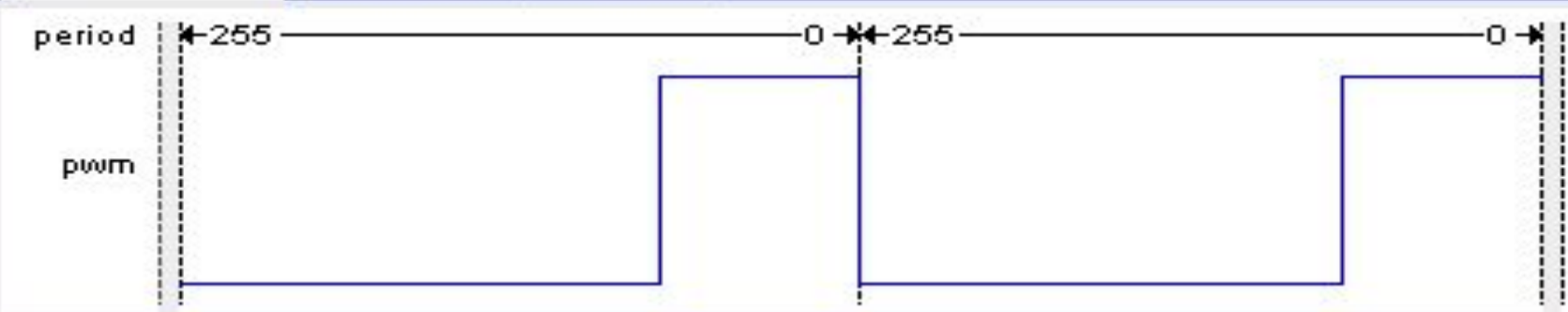

Implementation: Fixed Function UDB

Resolution: 8-Bit 16-Bit

PWM Mode: One Output

Period: *Period = 12.8ms*

CMP Value 1:

Configure 'PWM'

Name: PWM

Configure

Advanced

Built-in

Enable Mode: Software Only

Run Mode: Continuous

Trigger Mode: None

Kill Mode: Disabled

Capture Mode: None

Interrupts:

None

Interrupt On Terminal Count Event

Interrupt On Compare 1 Event

Interrupt On Compare 2 Event

Interrupt On Kill Event

Datasheet

OK

Apply

Cancel

Configure 'cy_clock'

Name:

Basic | Advanced | Built-in

Clock type: New Existing

Source:

Specify: Frequency: kHz +







Summary
API Generated: Yes
Uses Clock Tree Resource: Yes

By default, all clocks are marked as 'start on reset'. The setting can be changed in the Design Wide Resources editor.

Configure 'cy_pins'

Name:

Pins Mapping Reset Built-in

Number of Pins:      

[All Pins]

- Pin_1_0

Type General Input Output

- Analog
- Digital Input
 - HW Connection
- Digital Output
 - HW Connection
 - Output Enable
- Bidirectional
- Show External Terminal

Preview:



Datasheet OK Apply Cancel

Configure 'cy_pins'

Name:

Pins Mapping Reset Built-in

Number of Pins:

[All Pins]
 Pin_1_0

General Type Input Output

Drive Mode
Strong Drive

Initial State:
Low (0)

Minimum Supply Voltage:

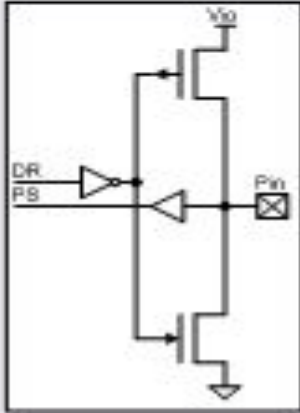

Datasheet OK Apply Cancel

Configure 'cy_pins'

Name: Pin_1

Pins

Mapping

Reset

Built-in

Number of Pins: 1

[All Pins]

Pin_1_0

Type

General

Input

Output

Drive Mode

Strong Drive

Initial State:

High (1)

Minimum Supply Voltage:

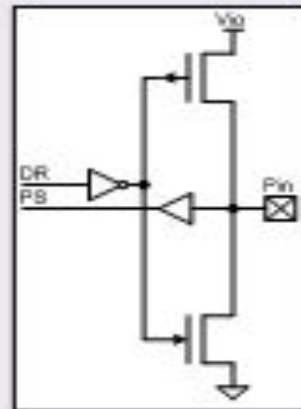

Datasheet

OK

Apply

Cancel

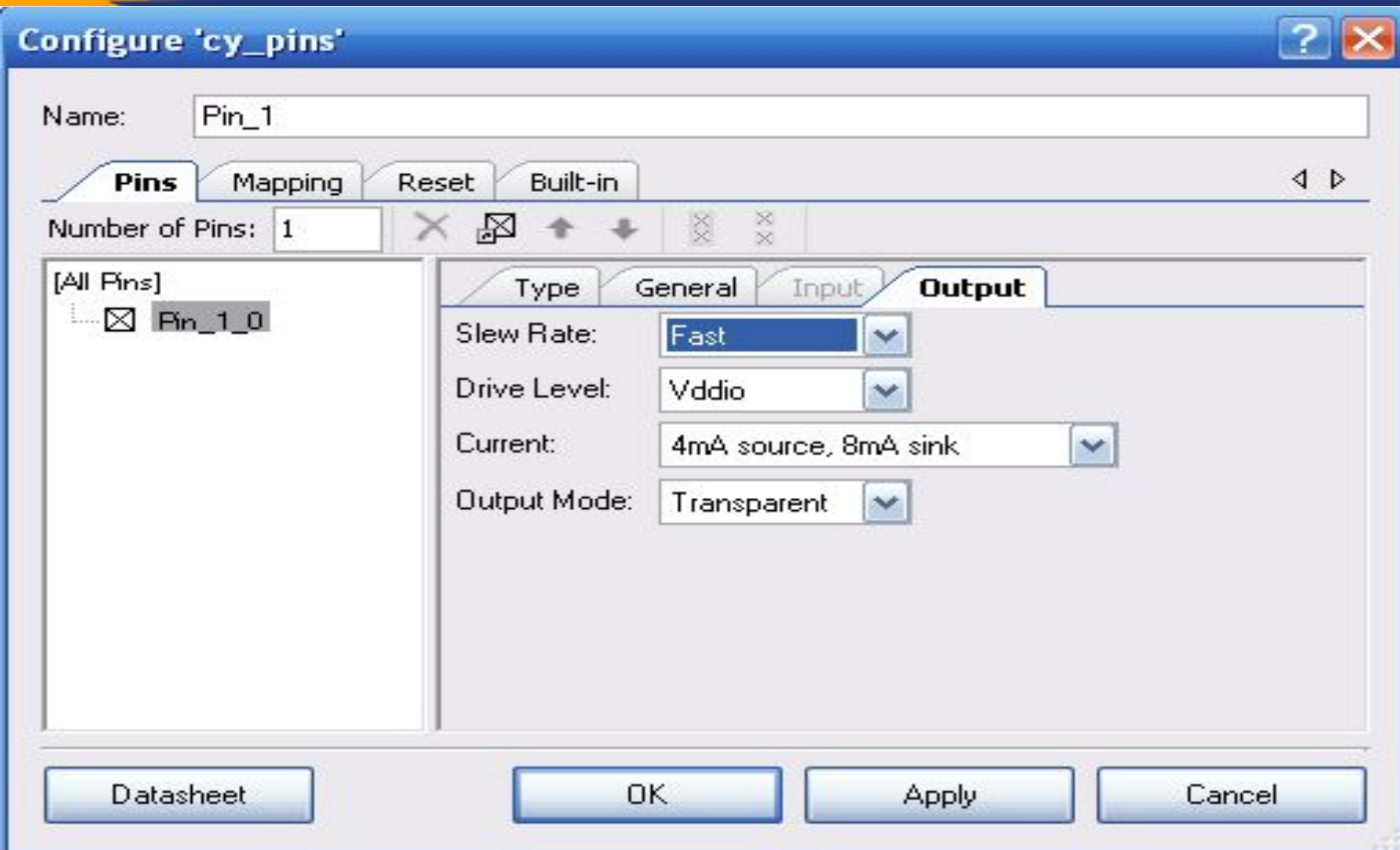

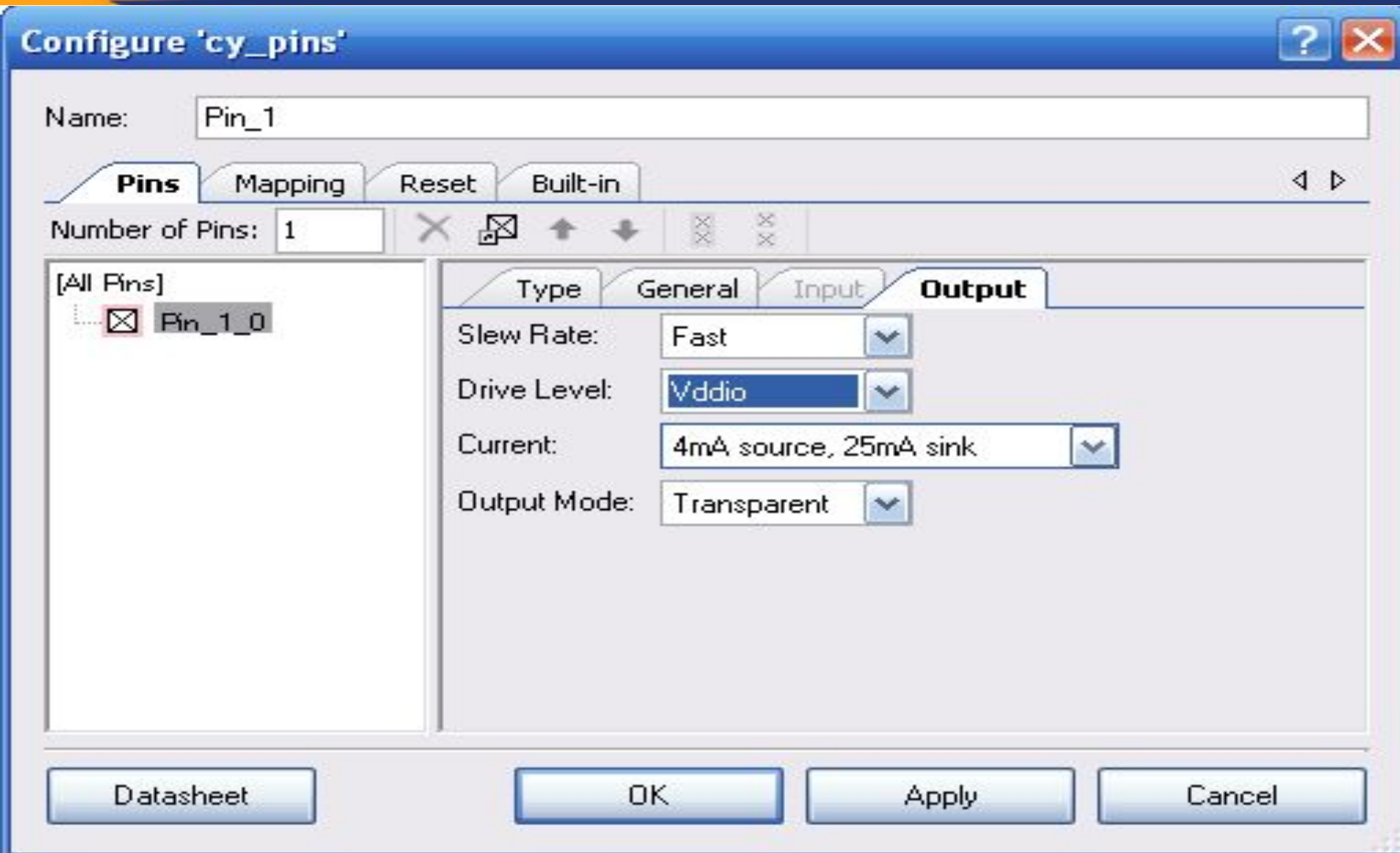

Start Page

*TopDesign.cysch

Dvyhun.cydwr

main.c

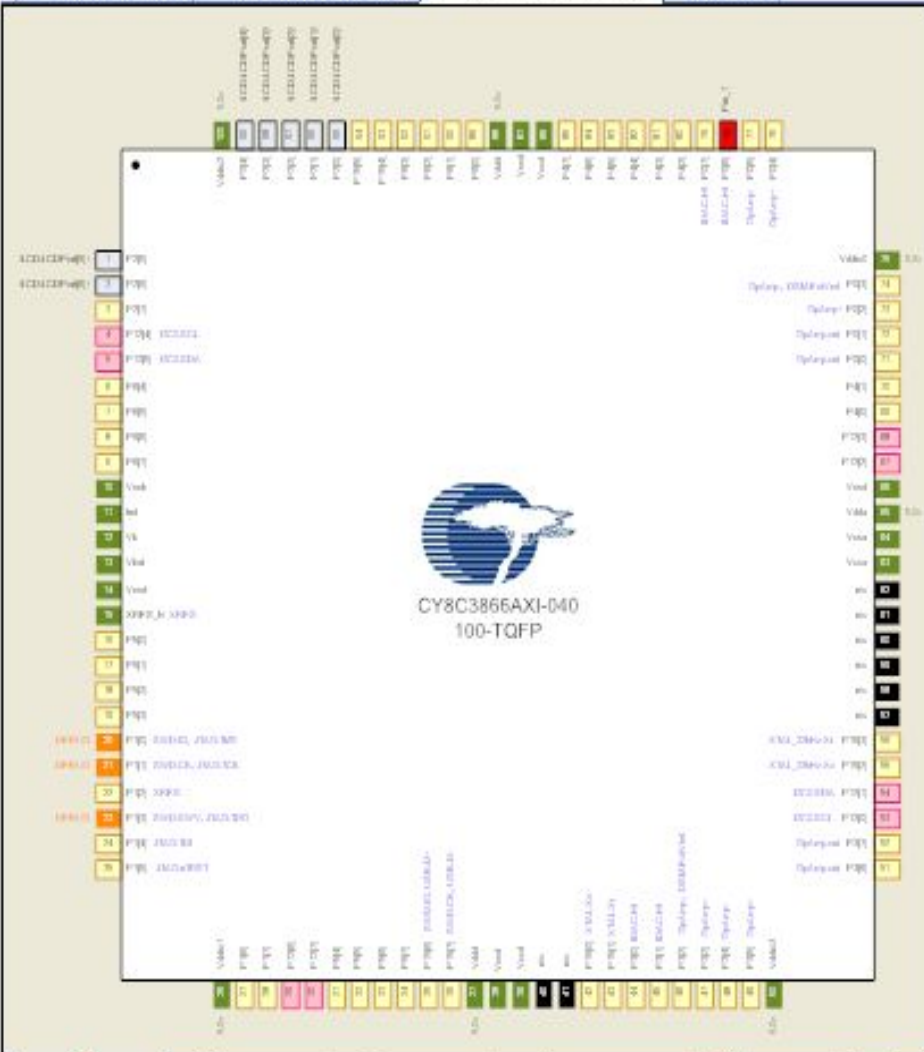
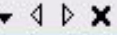

Alias	Name	Port	Pin	Lock
	\LCD:LCDPort[6:0]\	P2[6:0]	95..99,1..2	<input checked="" type="checkbox"/>
	Pin_1	P0[6] IDAC:HI	78	<input checked="" type="checkbox"/>

Configuration area for the selected pin, showing various settings and options. The area is currently empty, suggesting that the configuration options are not visible for the selected pin.

Start Page *TopDesign.cysch **Dvyhun.cydwr** main.c

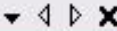

Add Design-Wide Clock... Delete Design-Wide Clock Edit Clock...

Type /	Name	Domain	Desired Frequency	Nominal Frequency	Accuracy (%)	Tolerance (%)	Divider	Start on Reset	Source Clock
System	USB_CLK	DIGITAL	48.000 MHz	? MHz	±0	-	1	<input type="checkbox"/>	IM0x2
System	Digital Signal	DIGITAL	? MHz	? MHz	±0	-	0	<input type="checkbox"/>	
System	XTAL 32kHz	DIGITAL	32.768 kHz	? MHz	±0	-	0	<input type="checkbox"/>	
System	XTAL	DIGITAL	25.000 MHz	? MHz	±0	-	0	<input type="checkbox"/>	
System	ILO	DIGITAL	? MHz	1.000 kHz	-50, +100	-	0	<input checked="" type="checkbox"/>	
System	IM0	DIGITAL	3.000 MHz	3.000 MHz	±1	-	0	<input checked="" type="checkbox"/>	
System	BUS_CLK (CPU)	DIGITAL	? MHz	24.000 MHz	±1	-	1	<input checked="" type="checkbox"/>	MASTER_CLK
System	MASTER_CLK	DIGITAL	? MHz	24.000 MHz	±1	-	1	<input checked="" type="checkbox"/>	PLL_OUT
System	PLL_OUT	DIGITAL	24.000 MHz	24.000 MHz	±1	-	0	<input checked="" type="checkbox"/>	IM0
Local	Clock	DIGITAL	20.000 kHz	20.000 kHz	±1	±5	150	<input checked="" type="checkbox"/>	Auto: IM0

Option	Value
Configuration	
Device Configuration Mode	Compressed
Enable Error Correcting Code (ECC)	<input type="checkbox"/>
Store Configuration Data in ECC Memory	<input checked="" type="checkbox"/>
Instruction Cache Enabled	<input checked="" type="checkbox"/>
Enable Fast IMO During Startup	<input checked="" type="checkbox"/>
Clear SRAM During Startup	<input checked="" type="checkbox"/>
Unused Bonded IO	Allow but warn
Programming\Debugging	
Debug Select	SWD+SWV (serial wire debug and viewer)
Enable Device Protection	<input type="checkbox"/>
Require XRES Pin	<input checked="" type="checkbox"/>
Use Optional XRES	<input type="checkbox"/>
Operating Conditions	

```
1 /* =====
2  * Copyright YOUR COMPANY, THE YEAR
3  * All Rights Reserved
4  * UNPUBLISHED, LICENSED SOFTWARE.
5  * CONFIDENTIAL AND PROPRIETARY INFORMATION
6  * WHICH IS THE PROPERTY OF your company.
7  * =====
8  */
9 #include <device.h>
10
11 void main()
12 {
13     /* Place your initialization/startup code here (e.g. MyInst_Start()) */
14     /* Enable the global interrupts */
15     CyGlobalIntEnable;
16     LCD_Start();
17     LCD_Position(0,9);
18     LCD_PrintString("Dvyhun");
19     /* CyGlobalIntEnable; */ /* Uncomment this line to enable global interrupts. */
20     PWM_Start();
21     for(;;)
22     {
23         /* Place your application code here. */
24     }
25 }
26
27 /* [] END OF FILE */
```

Вставити інтерфейс користувача для управління швидкістю обертання двигуна постійного струму

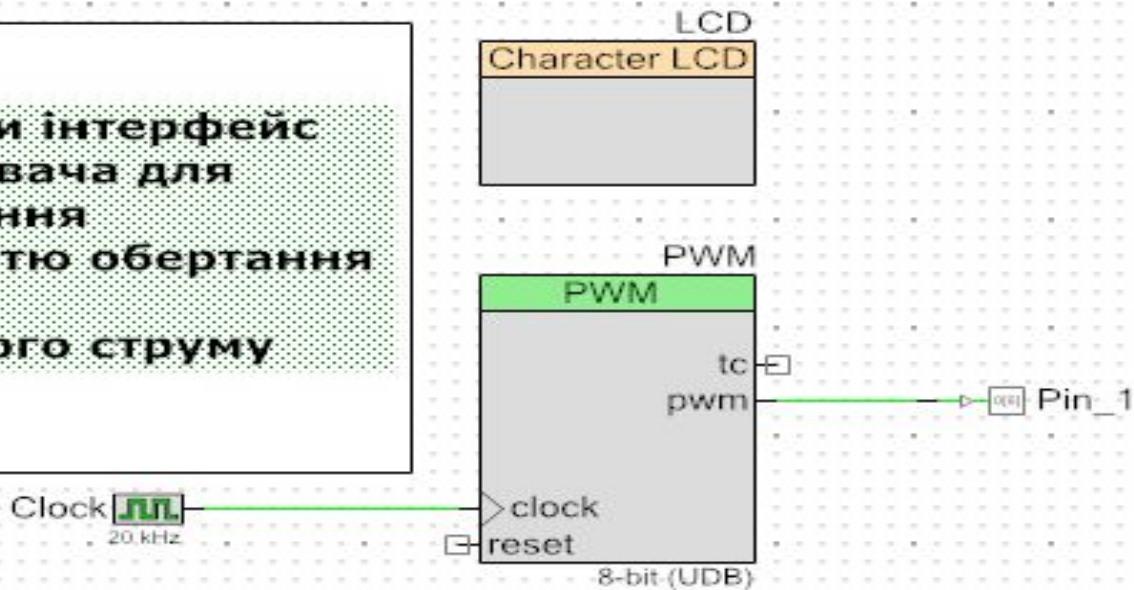



Lab_7 Fan

CHAPTER #HI

FanController Example Project - Firmware Fan Control
 Fan Controller is configured into firmware (CPU) fan control mode
 Speed control algorithm is implemented in firmware
 Firmware synchronizes to hardware using end-of-cycle (eoc) pulse
 2 Fans are supported (individual PWMs - no banks)

Sticky status register indicates when tachometer finishes reading speeds of all fans

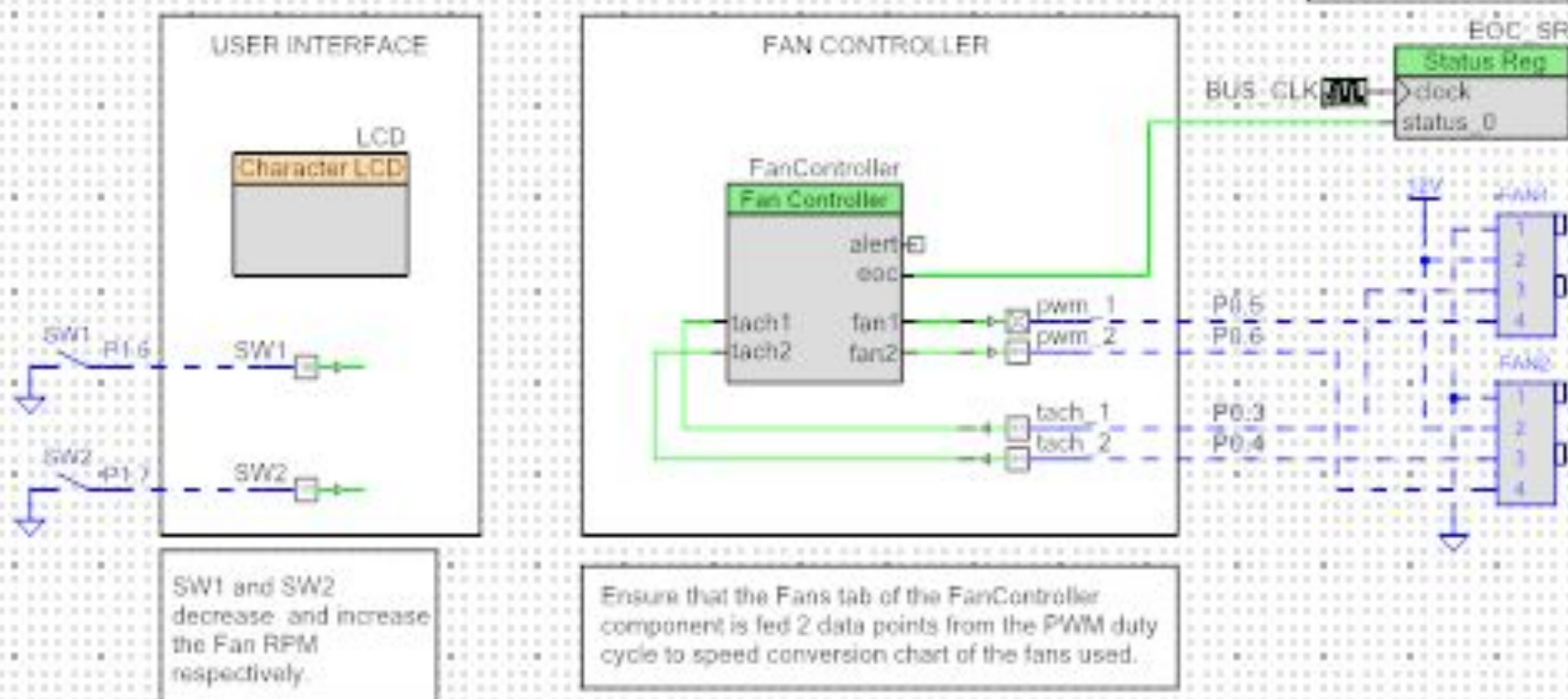

Configure 'CyStatusReg'

Name:

Configure Built-in

Inputs:

Display as bus

Generate interrupt

Bit	Mode
0	Sticky

Transparent

Cypress Off-Chip

Cypress Component Catalog

- [-] Analog
 - + ADC
 - + Amplifiers
 - + Analog MUX
 - Comparator [v2.0]
 - + DAC
 - + Manual Routing
 - Mixer [v2.0]
 - Sample/Track and Hold
 - VRef [v1.60]
- [-] CapSense
 - CapSense_CSD [v3.30]
- + Communications
- [-] Digital
 - + Functions
 - + Logic
 - [-] Registers
 - Control Register [v1.0]
 - Status Register [v1.0]
 - + Utility

Component Preview



Configuration Fan Controller

Configure 'FanController'

Name:

Basic | Fans | Built-in

Fan Control Method

Firmware (CPU)

Hardware (UDB)

Damping factor (sec):

Tolerance:

Acoustic noise reduction

Alerts

Fan stall / Rotor lock

UDB speed regulation failure

Connections

Display as bus

External clock

[Datasheet](#)



Configuration Fan Controller

Configure 'FanController' ? ✕

Name:

Basic **Fans** Built-in ◀ ▶

Motor support

4-pole motors

6-pole motors

PWM output configuration

Number of fans: ▲ ▼ Number of banks: ▼

PWM resolution: ▼ PWM frequency: ▼

Fan number	Enter 2 datapoints (A, B) from duty cycle to RPM curve for each fan/bank.				Initial RPM
	Duty cycle A (%)	RPM A	Duty cycle B (%)	RPM B	
1	<input type="text" value="35"/> ▲ ▼	<input type="text" value="4500"/> ▲ ▼	<input type="text" value="70"/> ▲ ▼	<input type="text" value="10500"/> ▲ ▼	<input type="text" value="4500"/> ▲ ▼
2	<input type="text" value="35"/> ▲ ▼	<input type="text" value="4500"/> ▲ ▼	<input type="text" value="70"/> ▲ ▼	<input type="text" value="10500"/> ▲ ▼	<input type="text" value="4500"/> ▲ ▼

Start Page

TopDesign.cysch

FW Fan Control01.cydw

◀ ▶ ✕

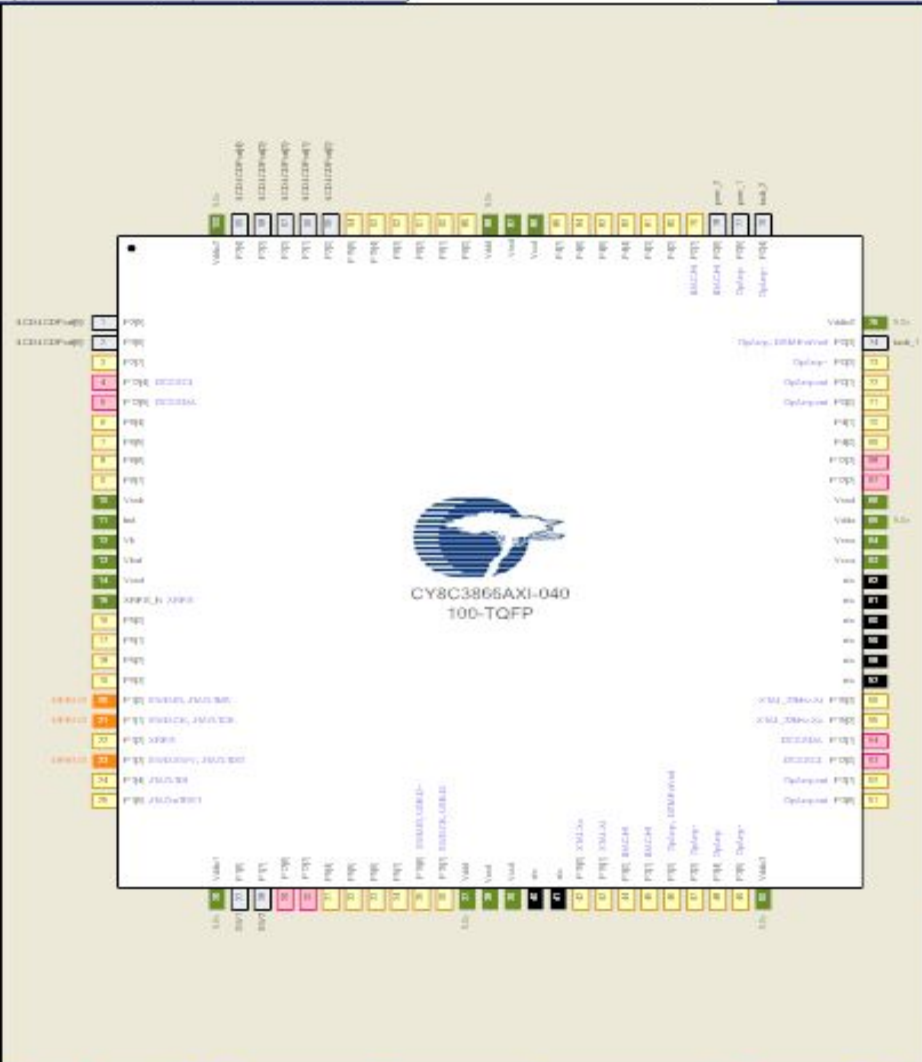

Alias	Name	Port	Pin
	\LCD:LCDPort[6:0]\	P2[6:0]	95..99,100
pwm_1	P0[5] OpAmp-		77
pwm_2	P0[6] IDAC:HI		78
SW1	P1[6]		27
SW2	P1[7]		28
tach_1	P0[3] OpAmp-, DSM:ExtVref		74
tach_2	P0[4] OpAmp+		76

Navigation and tool icons:









- ◀ | ||| | ▶
- ◀ ▶
- ◀ ▶

Type	Name	Domain	Desired Frequency	Nominal Frequency	Accuracy (%)	Tolerance (%)	Divider	Start on Reset	Source Clock
System	USB_CLK	DIGITAL	48.000 MHz	? MHz	±0	-	1	<input type="checkbox"/>	IM0x2
System	Digital Signal	DIGITAL	? MHz	? MHz	±0	-	0	<input type="checkbox"/>	
System	XTAL 32kHz	DIGITAL	32.768 kHz	? MHz	±0	-	0	<input type="checkbox"/>	
System	XTAL	DIGITAL	25.000 MHz	? MHz	±0	-	0	<input type="checkbox"/>	
System	ILO	DIGITAL	? MHz	1.000 kHz	-50, +100	-	0	<input checked="" type="checkbox"/>	
System	IM0	DIGITAL	3.000 MHz	3.000 MHz	±1	-	0	<input checked="" type="checkbox"/>	
System	BUS_CLK (CPU)	DIGITAL	? MHz	24.000 MHz	±1	-	1	<input checked="" type="checkbox"/>	MASTER_CLK
System	MASTER_CLK	DIGITAL	? MHz	24.000 MHz	±1	-	1	<input checked="" type="checkbox"/>	PLL_OUT
System	PLL_OUT	DIGITAL	24.000 MHz	24.000 MHz	±1	-	0	<input checked="" type="checkbox"/>	IM0
Local	FanController_TACH_CLK_500K	DIGITAL	500.000 kHz	500.000 kHz	±1	±5	6	<input checked="" type="checkbox"/>	Auto: IM0
Local	FanController_PwM_CLOCK_25k_10b	DIGITAL	24.000 MHz	24.000 MHz	±1	-	1	<input checked="" type="checkbox"/>	MASTER_CLK
Local	FanController_BUS_CLK	DIGITAL	? MHz	24.000 MHz	±1	-	0	<input checked="" type="checkbox"/>	BUS_CLK
Local	Clock_1	DIGITAL	? MHz	24.000 MHz	±1	-	0	<input checked="" type="checkbox"/>	BUS_CLK

Start Page | TopDesign.cysch | **FW Fan Control01.cydwr** | main.c

Reset | Expand | Collapse

Option	Value
Configuration	
Device Configuration Mode	DMA
Enable Error Correcting Code (ECC)	<input type="checkbox"/>
Store Configuration Data in ECC Memory	<input checked="" type="checkbox"/>
Instruction Cache Enabled	<input checked="" type="checkbox"/>
Enable Fast IMD During Startup	<input checked="" type="checkbox"/>
Clear SRAM During Startup	<input checked="" type="checkbox"/>
Unused Bonded IO	Allow but warn
Programming\Debugging	
Debug Select	SWD+SWV (serial wire debug and viewer)
Enable Device Protection	<input type="checkbox"/>
Require XRES Pin	<input checked="" type="checkbox"/>
Use Optional XRES	<input type="checkbox"/>
Operating Conditions	
Vddd (V)	5.0
Vdda (V)	5.0
Variable Vdda	<input type="checkbox"/>
Vddio0 (V)	5.0
Vddio1 (V)	5.0

 Pins |
  Analog |
  Clocks |
  Interrupts |
  DMA |
  **System** |
  Directives |
  Flash Security

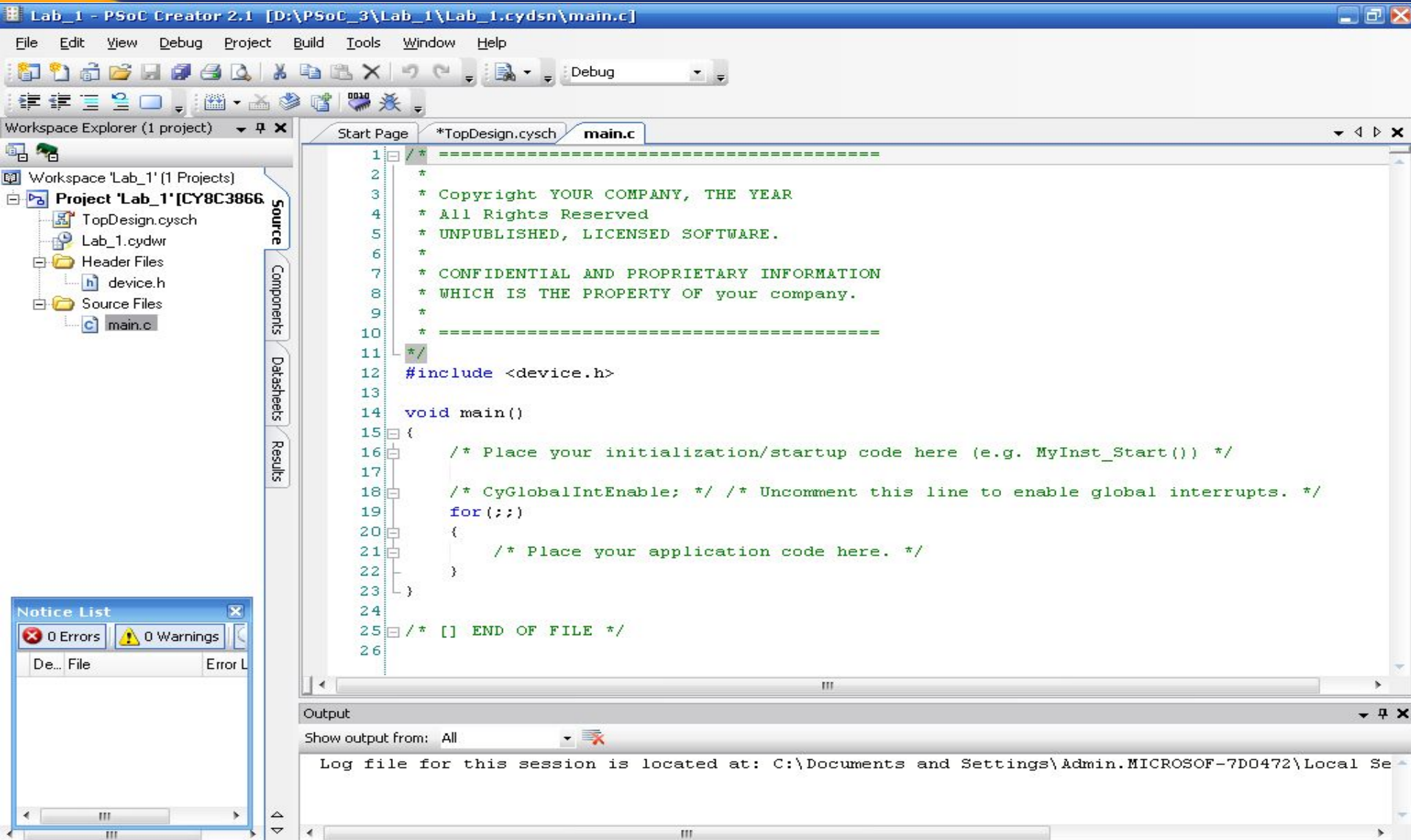

Lab_1 - PSoC Creator 2.1 [D:\PSoC_3\Lab_1\Lab_1.cydsn\main.c]

File Edit View Debug Project Build Tools Window Help

Debug

Workspace Explorer (1 project)

Project 'Lab_1' [CY8C3866]

- TopDesign.cysch
- Lab_1.cydwr
- Header Files
- device.h
- Source Files
- main.c

```
1  /* -----  
2  *  
3  * Copyright YOUR COMPANY, THE YEAR  
4  * All Rights Reserved  
5  * UNPUBLISHED, LICENSED SOFTWARE.  
6  *  
7  * CONFIDENTIAL AND PROPRIETARY INFORMATION  
8  * WHICH IS THE PROPERTY OF your company.  
9  *  
10 * -----  
11 */  
12 #include <device.h>  
13  
14 void main()  
15 {  
16     /* Place your initialization/startup code here (e.g. MyInst_Start()) */  
17  
18     /* CyGlobalIntEnable; */ /* Uncomment this line to enable global interrupts. */  
19     for (;;)   
20     {  
21         /* Place your application code here. */  
22     }  
23 }  
24  
25 /* [] END OF FILE */  
26
```

Notice List

0 Errors 0 Warnings

De...	File	Error L
-------	------	---------

Output

Show output from: All

Log file for this session is located at: C:\Documents and Settings\Admin.MICROSOFT-7D0472\Local Se

Ln 1 Col 1 INS 0 Errors 0 Warnings 0 Notes

```
1 /*****
2 * Project Name:      Firmware Fan Control
3 * Version:          1.10
4 *
5 * Device Used:      PSoC 3 CY8C3866AXI-040 or PSoC 5 CY8C5588AXI-060ES1
6 * Software Used:    PSoC Creator v2.1
7 * Compiler Used:    Keil(C51), ARM GNU CC
8 * Related Hardware: CY8CKIT-001 PSoC DVK
9 *****/
10 * Theory of Operation:
11 *
12 * Fan Controller is configured into firmware (CPU) fan control mode
13 * Speed control algorithm is implemented in firmware
14 * Firmware synchronizes to hardware using end-of-cycle (eoc) pulse
15 * 2 Fans are supported (individual PWMs - no banks)
16 *
17 * 1st line of LCD displays Desired Speed and Actual Speed and PWM Duty Cycle of Fan 1
18 * 2nd line of LCD displays Actual Speed and PWM Duty Cycle of Fan 2
19 * SW1 decreases desired speed in RPM
20 * SW2 increases desired speed in RPM
21 *
22 *****/
23 * Copyright 2012, Cypress Semiconductor Corporation. All rights reserved.
24 * This software is owned by Cypress Semiconductor Corporation and is protected
25 * by and subject to worldwide patent and copyright laws and treaties.
26 * Therefore, you may use this software only as provided in the license agreement
27 * accompanying the software package from which you obtained this software.
28 * CYPRESS AND ITS SUPPLIERS MAKE NO WARRANTY OF ANY KIND, EXPRESS OR IMPLIED,
29 * WITH REGARD TO THIS SOFTWARE, INCLUDING, BUT NOT LIMITED TO, NONINFRINGEMENT,
30 * IMPLIED WARRANTIES OF MERCHANTABILITY AND FITNESS FOR A PARTICULAR PURPOSE.
31 *****/
```

```
31 | *****/
32 |
33 | #include <device.h>
34 | #include <stdio.h>
35 |
36 | /* PWM duty cycle controls - units are hundredths of a percent */
37 | #define MIN_DUTY          (50u)
38 | #define MAX_DUTY          (9950u)
39 | #define DUTY_STEP_COARSE  (100u)
40 | #define DUTY_STEP_FINE    (2u)
41 |
42 | /* Speed controls - units are RPM */
43 | #define MIN_RPM           (2500u)
44 | #define MAX_RPM           (9500u)
45 | #define INIT_RPM          (4500u)
46 | #define RPM_STEP          (500u)
47 | #define RPM_DELTA_LARGE   (500u)
48 | #define RPM_TOLERANCE     (100u)
49 |
50 | void main()
51 | {
52 |     uint16  desiredSpeed = INIT_RPM;
53 |     uint16  dutyCycle[2];
54 |     uint8   fanNumber;
55 |     char    displayString[6];
56 |
57 |     FanController_Start();
58 |     FanController_SetDesiredSpeed(1u, desiredSpeed);
59 |     FanController_SetDesiredSpeed(2u, desiredSpeed);
60 |     dutyCycle[0] = FanController_GetDutyCycle(1u);
61 |     dutyCycle[1] = FanController_GetDutyCycle(2u);
62 |
```

```
61 dutyCycle[1] = FanController_GetDutyCycle(2u);
62 LCD_Start();
63 LCD_Position(0u, 0u);
64 LCD_PrintDecUint16(desiredSpeed);
65 LCD_Position(1u, 0u);
66 LCD_PrintString("F/W");
67 while(1u)
68 {
69     /* Synchronize firmware to end-of-cycle pulse from FanController */
70     if(EOC_SR_Read())
71     {
72         for(fanNumber = 1u; fanNumber <= 2u; fanNumber++)
73         {
74             /* Display Fan Actual Speeds */
75             LCD_Position(fanNumber-1, 5u);
76             LCD_PrintDecUint16(FanController_GetActualSpeed(fanNumber));
77             LCD_PrintString("  ");
78
79             /* Firmware Speed Regulation */
80             LCD_Position(fanNumber-1, 9u);
81
82             /* Fan Below Desired Speed */
83             if(FanController_GetActualSpeed(fanNumber) < desiredSpeed)
84             {
85                 if((desiredSpeed - FanController_GetActualSpeed(fanNumber)) > RPM_DELTA_L)
86                 {
87                     dutyCycle[fanNumber-1] += DUTY_STEP_COARSE;
88                 }
89                 else
90                 {
91                     dutyCycle[fanNumber-1] += DUTY_STEP_FINE;
92                 }
93             }
94         }
95     }
96 }
```

```
89     else
90     {
91         dutyCycle[fanNumber-1] += DUTY_STEP_FINE;
92     }
93     if(dutyCycle[fanNumber-1] > MAX_DUTY)
94     {
95         dutyCycle[fanNumber-1] = MAX_DUTY;
96     }
97 }
98 /* Fan Above Desired Speed */
99 else if(FanController_GetActualSpeed(fanNumber) > desiredSpeed)
100 {
101     if((FanController_GetActualSpeed(fanNumber) - desiredSpeed) > RPM_DELTA_L)
102     {
103         if(dutyCycle[fanNumber-1] > (MIN_DUTY+DUTY_STEP_COARSE))
104         {
105             dutyCycle[fanNumber-1] -= DUTY_STEP_COARSE;
106         }
107     }
108     else if((FanController_GetActualSpeed(fanNumber) - desiredSpeed) > RPM_TO)
109     {
110         if(dutyCycle[fanNumber-1] > MIN_DUTY)
111         {
112             dutyCycle[fanNumber-1] -= DUTY_STEP_FINE;
113         }
114     }
115 }
116 FanController_SetDutyCycle(fanNumber, dutyCycle[fanNumber-1]);
117
118 /* Display Current Duty Cycle Settings (in 100ths of a percent) */
119 LCD_Position(fanNumber-1,10u);
```

```
120     sprintf(displayString, "%5.2f", (((float)dutyCycle[fanNumber-1])/100));
121     LCD_PrintString(displayString);
122     LCD_PrintString("%    ");
123 }
124 CyDelay(250u);
125
126 /* Check for Button Press to Change Speed */
127 if((!SW1_Read()) || (!SW2_Read()))
128 {
129     /* Decrease Speed */
130     if(!SW1_Read())
131     {
132         if(desiredSpeed > MIN_RPM)
133         {
134             desiredSpeed -= RPM_STEP;
135         }
136     }
137
138     /* Increase Speed */
139     else
140     {
141         desiredSpeed += RPM_STEP;
142         if(desiredSpeed > MAX_RPM)
143         {
144             desiredSpeed = MAX_RPM;
145         }
146     }
147
148     /* Display Updated Desired Speed */
149     LCD_Position(0u, 0u);
150     LCD_PrintDecUint16(desiredSpeed);
```

```
135     }
136   }
137
138   /* Increase Speed */
139   else
140   {
141     desiredSpeed += RPM_STEP;
142     if(desiredSpeed > MAX_RPM)
143     {
144       desiredSpeed = MAX_RPM;
145     }
146   }
147
148   /* Display Updated Desired Speed */
149   LCD_Position(0u, 0u);
150   LCD_PrintDecUint16(desiredSpeed);
151   FanController_SetDesiredSpeed(1u, desiredSpeed);
152   FanController_SetDesiredSpeed(2u, desiredSpeed);
153   dutyCycle[0] = FanController_GetDutyCycle(1u);
154   dutyCycle[1] = FanController_GetDutyCycle(2u);
155
156   /* Switch Debounce */
157   CyDelay(250u);
158 }
159 }
160 }
161 }
162
163
164 /* [] END OF FILE */
165
```

Fan Module

CY3210-ExpressDK and CY3210-FanMod

Using the on-board 3-wire, speed controllable, 5V external FET driven fan

- 1) Select appropriate PSoC Express output device:
Fan >> Brushless DC >> Speed Control >> External Drive FET >> 5V 2-/3-Wire.

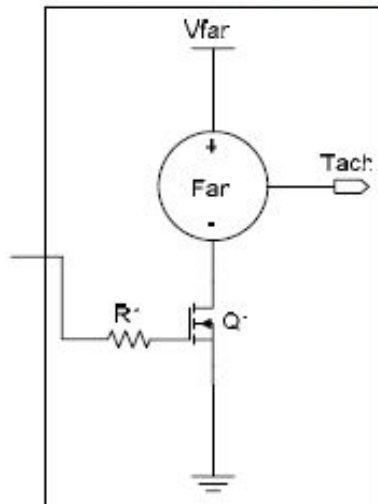

- 2) Verify physical connection (on-board fan to terminal block).

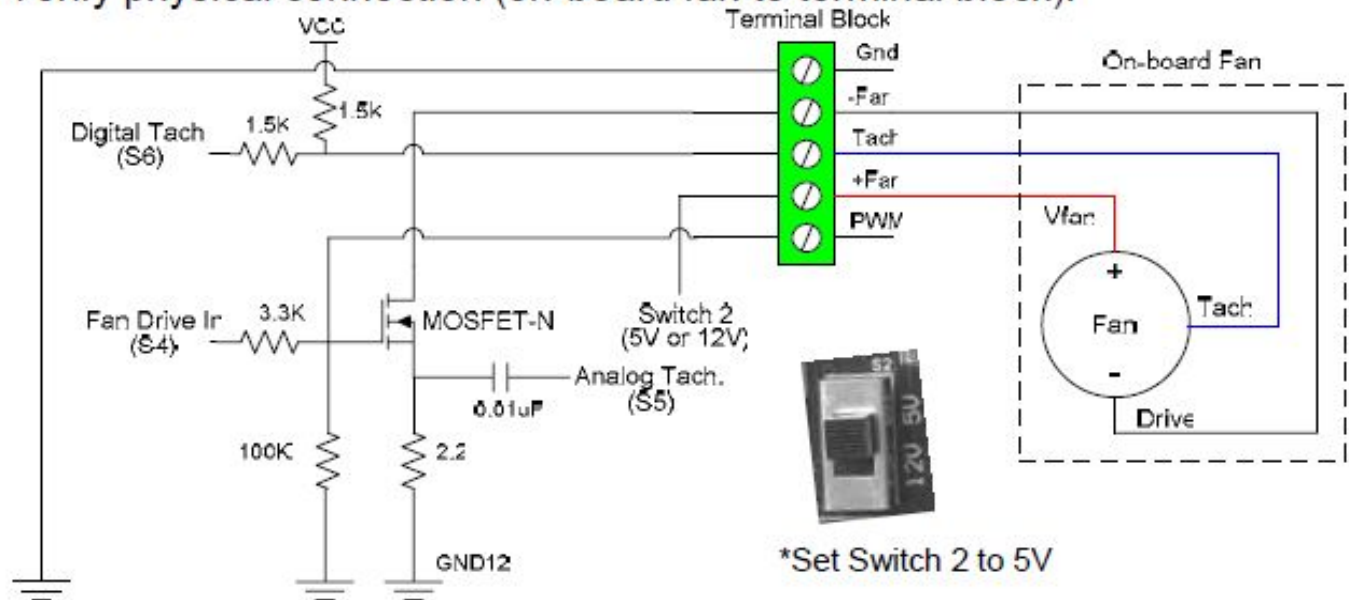

Attaching an off-board 4-wire, speed controllable, 12V integrated FET driven fan

- 1) Select appropriate PSoC Express output device::
Fan >> Brushless DC >> Speed Control >> Integrated Drive >> 12V 4-Wire.

- 2) Connect off-board fan to terminal block.

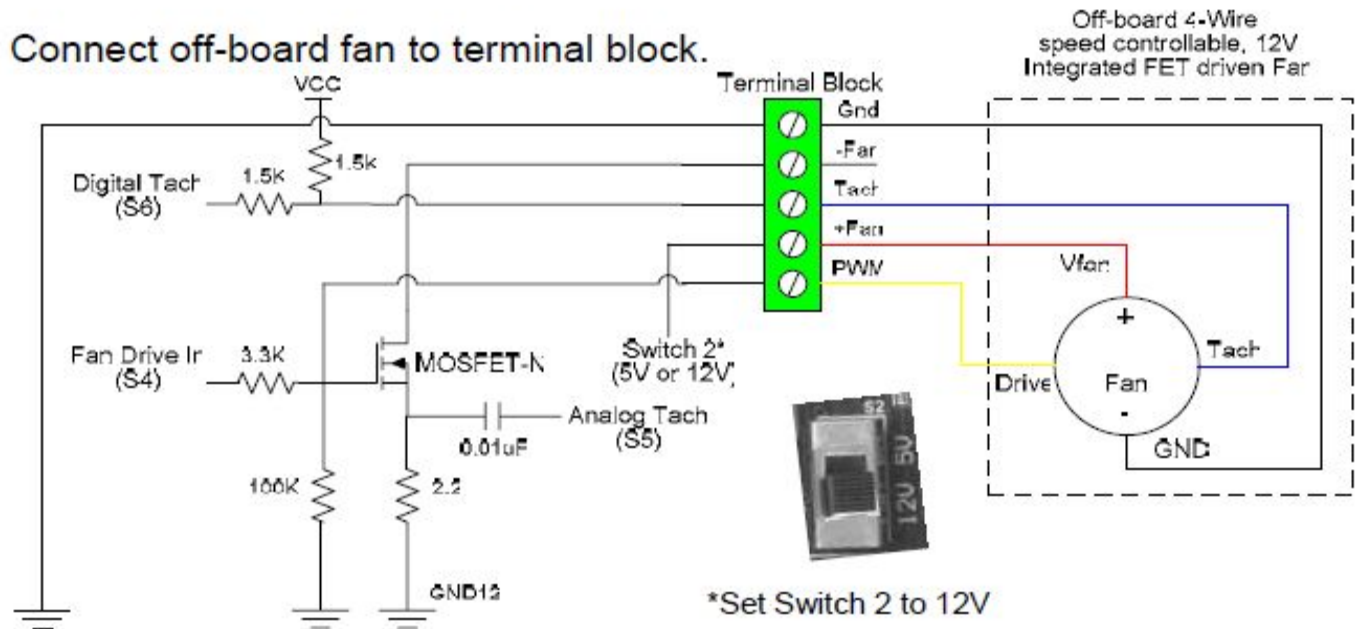
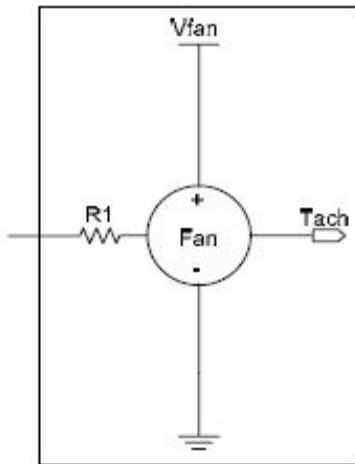

Using the LM20

- 1) Select appropriate PSoC Express input device:
Temperature >> Integrated Circuits >> LM20 -55 to +130C.
- 2) Set Switch 1 to LM20. (LM20 Vout available on S0).

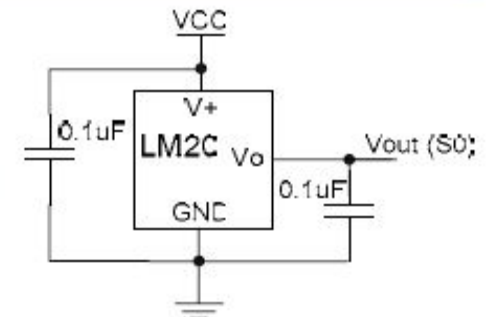

Using the Thermistor

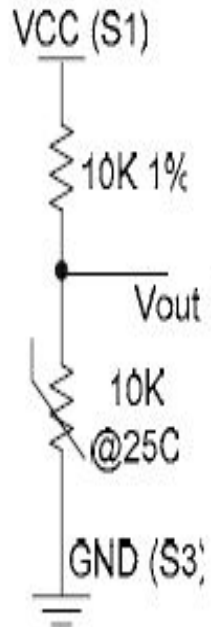

1) Select appropriate PSoC Express input device:
Temperature >> Thermistor Temp Sensor.

- 2) Set Switch 1 to LM20
- Vcc available on S1
 - VTherm available on S2
 - GND available on S3



Diode Sensor Topologies

The Diode Sensor will be supported in future releases of PSoC Express.



Рекомендована література :

Основна:

1. AN66627 PSoC® 3 and PSoC 5LP Intelligent Fan Controller . 2011 . - 22 с.
2. PSoC® 3 Architecture TRM (Technical Reference Manual) – 379 с.

Додаткова:

1. PSoC® Creator™ Component Datasheet.
Fan Controller – 6 с.

На сайті фірми Cypress знаходиться більше **200** Application Notes і Reference Designs, які ілюструють області застосування мікроконтролерів PSoC.

Design Support - Microsoft Internet Explorer

Address: <http://www.cypress.com/portal/server.pt?space=CommunityPage&control=SetCommunity&Communi>

Design Resources

Select one of the following materials to help you design-in Cypress products: Application Notes, Datasheets, Developer Kits, Errata Updates, Evaluation Boards, Models, Reference Designs, Software & Drivers and Technical Articles.

Select Product Group: -- All Product Groups --

Select Product Family: -- All Product Families --
 Application Specific Clocks
 Async SRAMs
 Automotive Products
 Backplane Interface & Clock Mgmt
 Bluetooth Solutions

Apply Filter

Application Notes	Datasheets	Developer Kits	Errata Update	Evaluation Boards
Models	More Resources	Reference Designs	Software and Drivers	Technical Articles

Technical Support

Product Family | **Descriptive Name** | **Date** | **Downloads**

Product Family	Descriptive Name	Date	Downloads
PSoC Mixed-Signal Array	AN2267a - Standard - Single Cell Li-Ion Battery Charger using CY8C21xxx	Apr 19, 2005	AN2267A.PDF AN2267A.ZIP
PSoC Mixed-Signal Array	AN2260 - Standard - Rapid NiCd/NiMH Battery Charger and DC Brushed Motor Controller for Autonomous Appliances	Apr 15, 2005	AN2260.PDF AN2260.ZIP
PSoC Mixed-Signal Array	AN2026b - Support - In-System Serial Programming Protocol CY8C24794 and CY8C29xxx	Apr 8, 2005	AN2026B.PDF
PSoC Mixed-Signal Array	AN2266 - Support - 16-Bit PWM/PWM-DACs using One Digital PSoC(TM) Block	Apr 8, 2005	AN2266.PDF AN2266.ZIP
PSoC Mixed-Signal Array	AN2279 - Support - Dynamic I2C Addressing Implemented with I2C Hardware User Modules	Apr 8, 2005	AN2279.PDF AN2279.ZIP
PSoC Mixed-Signal Array	AN2267 - Standard - Single Cell Li-Ion Battery Charger	Apr 1, 2005	AN2267.PDF AN2267.ZIP
PSoC Mixed-Signal Array	AN2222a - Support - Flex-Pod Soldering Guide	Mar 31, 2005	AN2222A.PDF
PSoC Mixed-Signal Array	AN2233a - Support - Capacitive Switch Scan	Mar 31, 2005	AN2233A.PDF
PSoC Mixed-Signal Array	AN2276 - Support - Binary Weighted Single-Pole IIR Low-Pass Filters	Mar 29, 2005	AN2276.PDF AN2276.ZIP
PSoC Mixed-Signal Array	AN2277 - Support - Capacitive Front Panel Display Demonstration	Mar 29, 2005	AN2277.PDF AN2277.ZIP

Found 201 items 1 - 10 | 11 - 20 | 21 - 30 | 31 - 40 | 41 - 50 | 51 - 60 | 61 - 70 | 71 - 80 | 81 - 90 | 91 - 100 | see 1 - 100 | next 100

Contact Us | Privacy | Terms & Conditions | How to Buy | 日本語 | 中文

© Copyright 1995-2005. Cypress Semiconductor Corporation. All rights reserved.

Мікропроцесорн а техніка 2019 р. (лекція 7, кінець) Благітко Б.Я.

