

Решение задачи на готовых чертежах. Центральный

Геометрия. 8 класс.



1

2

3

4

5

6

7

8

9

10

11

12

13

14

15

16

17

18

19

20

21

22

23

24

25

26

27

28

29

30

31

32

33

34

35

36

1.

Дано:

$AB \parallel CD; BC \parallel AD$

Доказать:

$BC = AD; \angle A = \angle C$

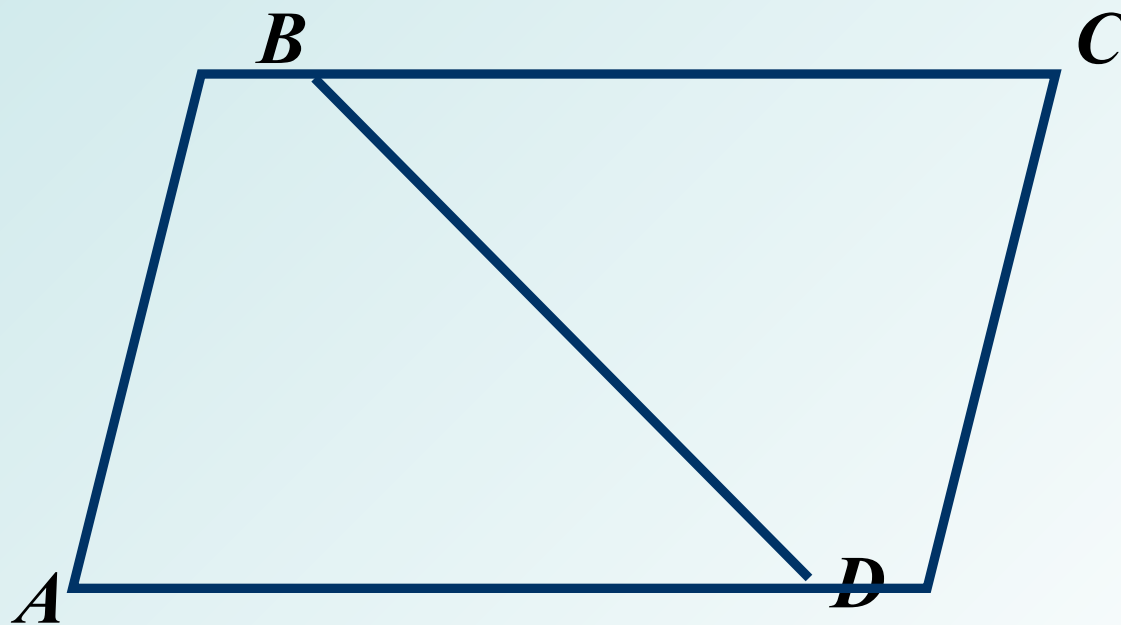

2.

Дано: $AB \parallel CD$; $AB = CD$

Доказать: O – середина AC и BD

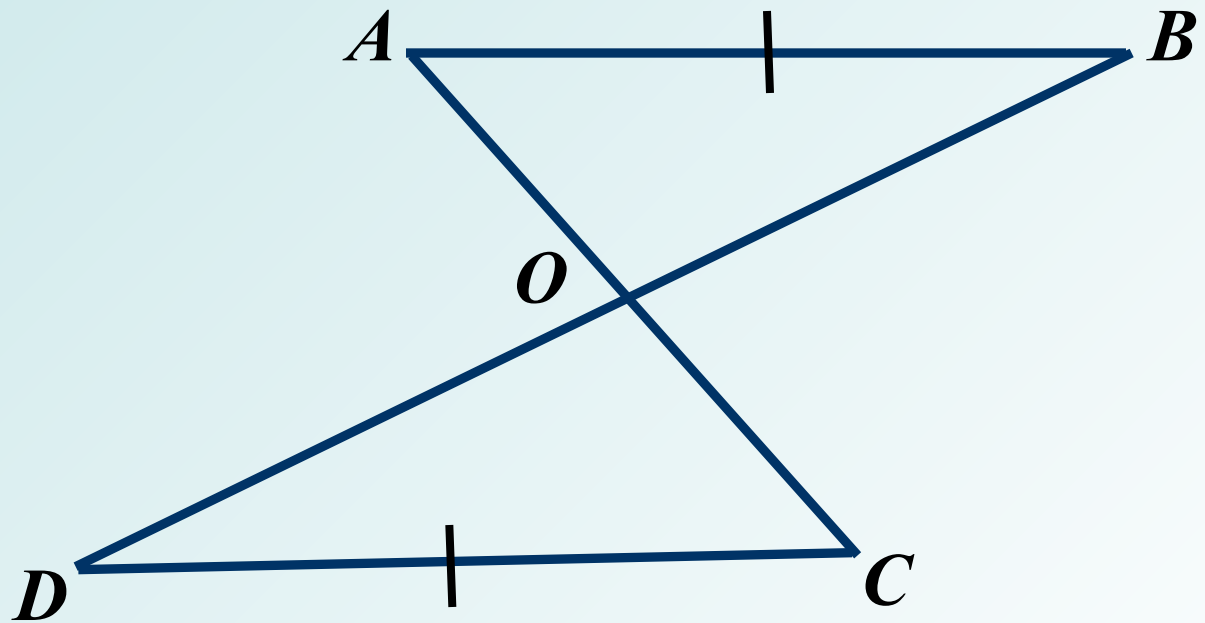

3.

Дано: $\angle 1 = \angle 2$, $\angle 3 = \angle 4$

Доказать: $ABCD$ – параллелограмм

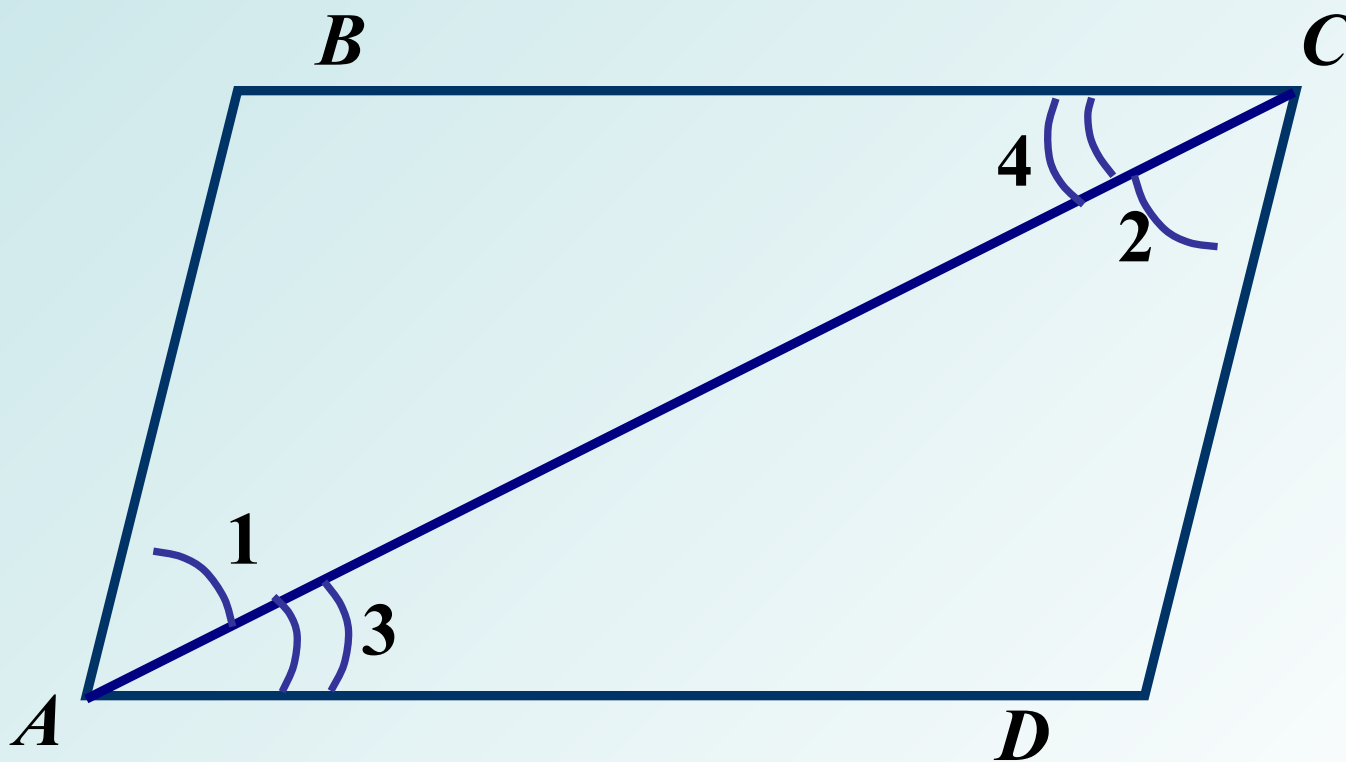

4.

Дано:

$MNPRQ$, $\angle M = \angle P$

Доказать:

$MNPRQ$ – параллелограмм

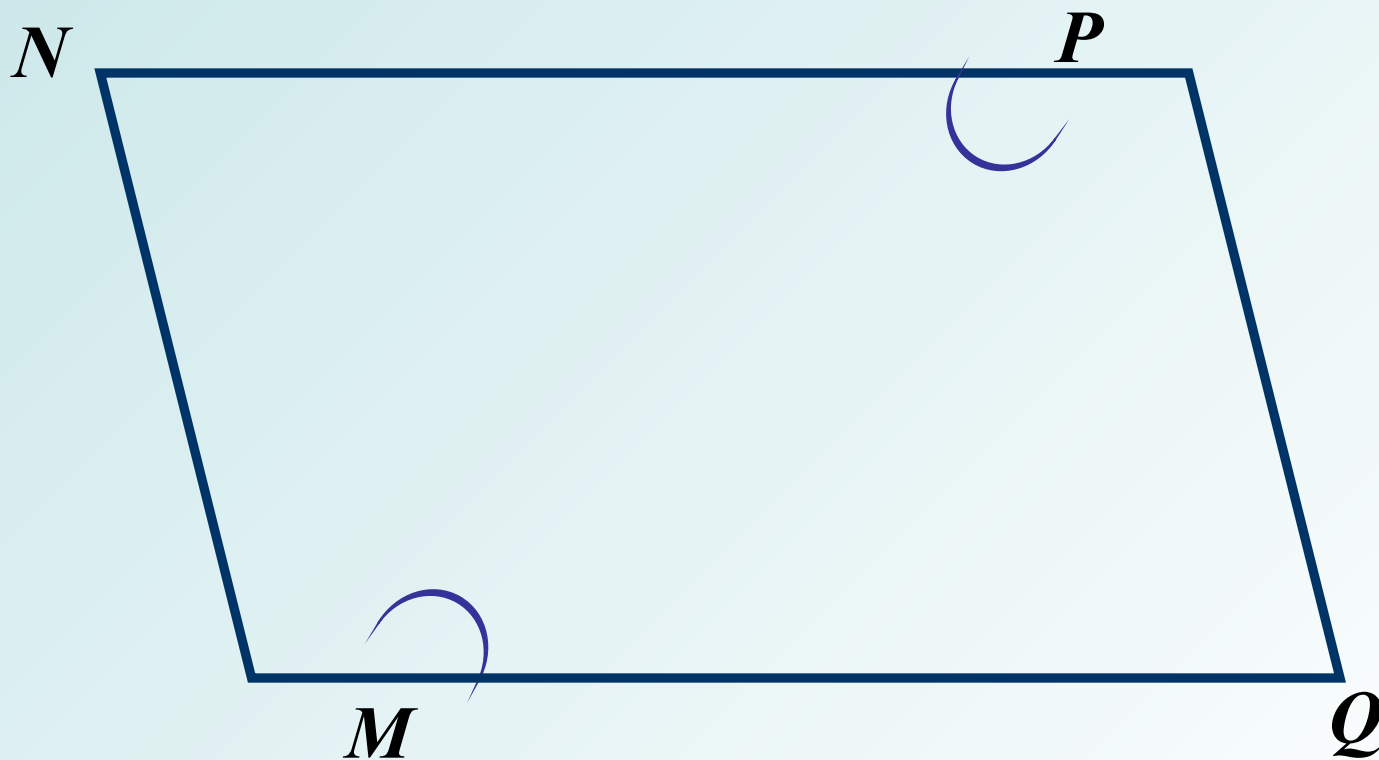

5.

Дано:

$$\angle 1 = \angle 2 = \angle 3$$

Доказать:

ABCD – параллелограмм

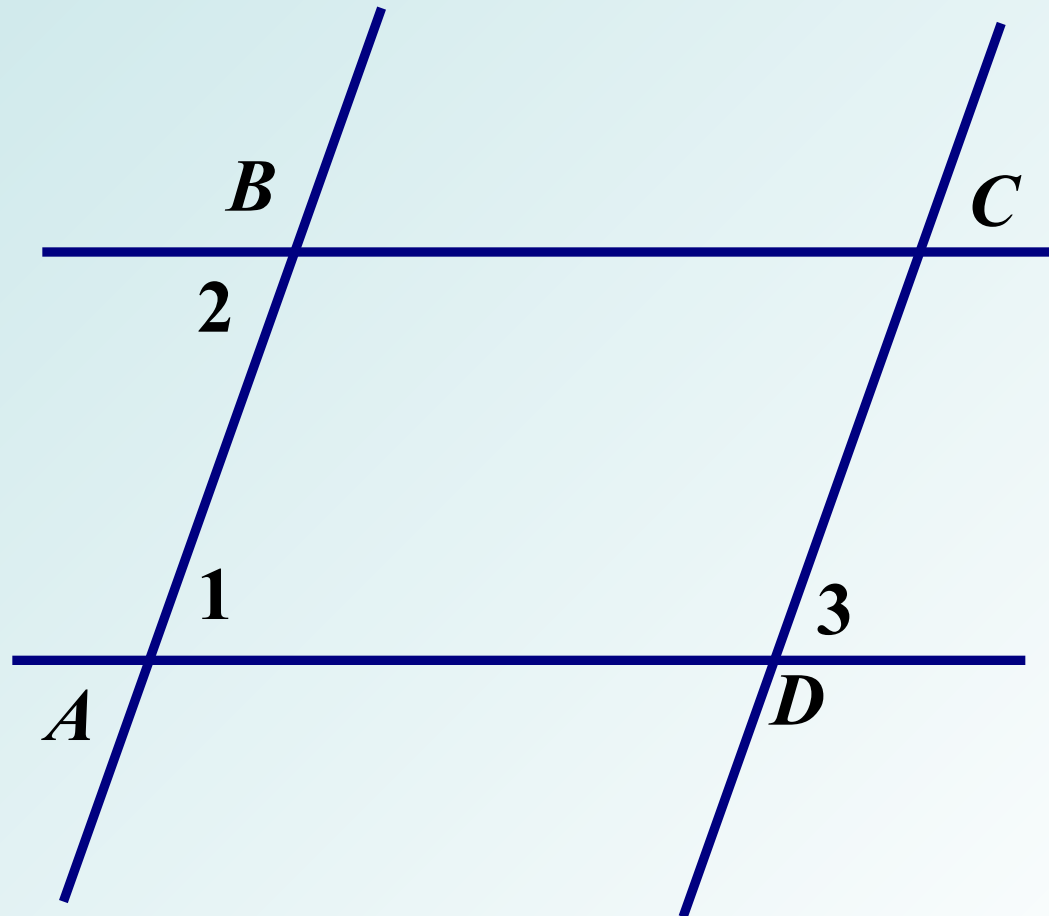

6.

Дано:

a) $\angle 1 = 70^\circ$; $\angle 3 = 110^\circ$; $\angle 2 + \angle 3 = 180^\circ$

á) $\angle 1 = \angle 2$; $\angle 2 \neq \angle 4$

Вопрос:

Является ли $ABCD$ параллелограммом

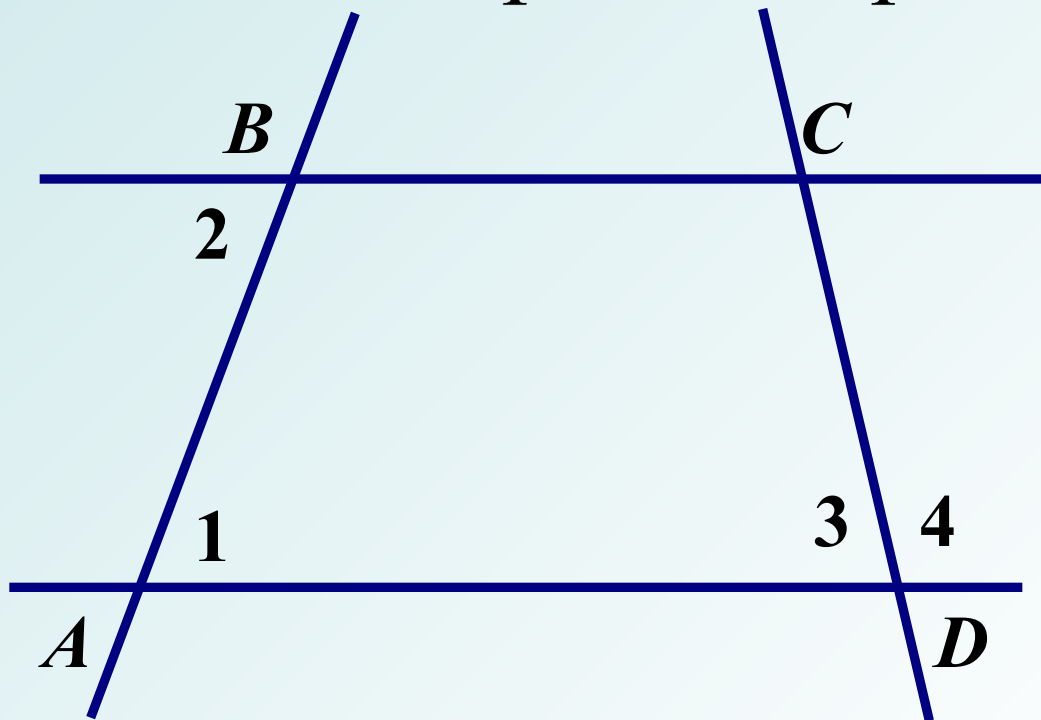

7.

Дано: $ABCD$ – параллелограмм

Найти: $\angle C, \angle D$

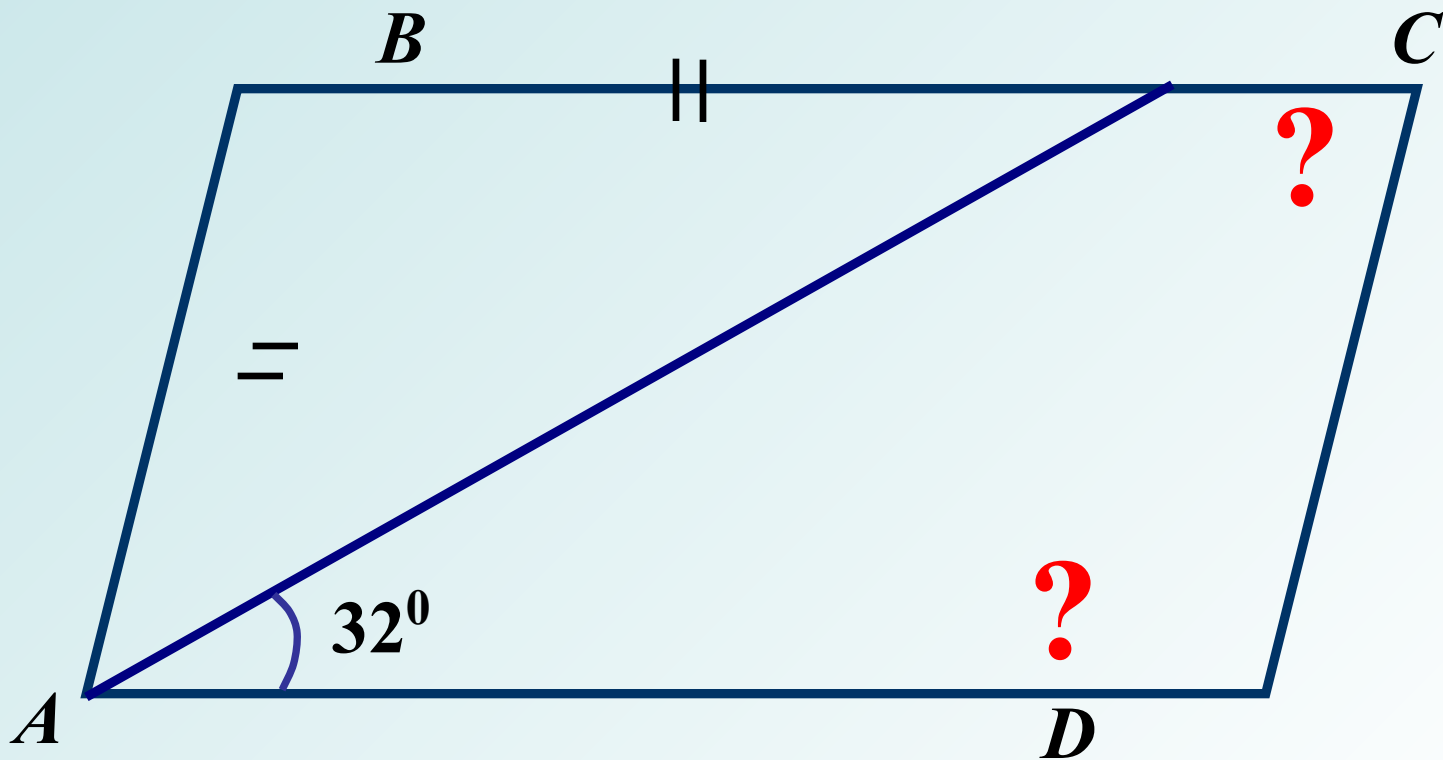

8.

Дано: $MNKP$ – параллелограмм

Найти: MP ; PK

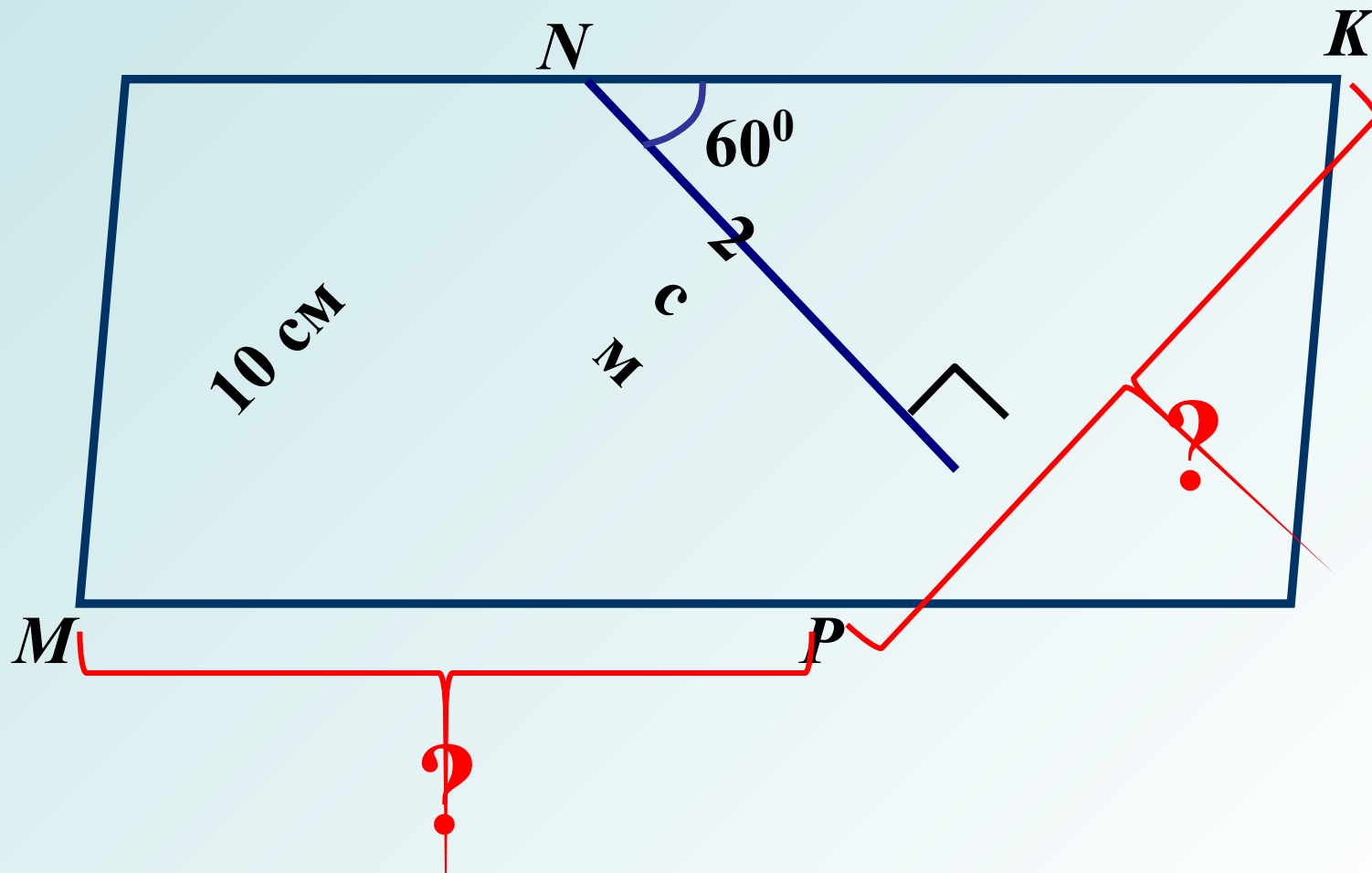

9.

Найти:

углы параллелограмма $ABCD$

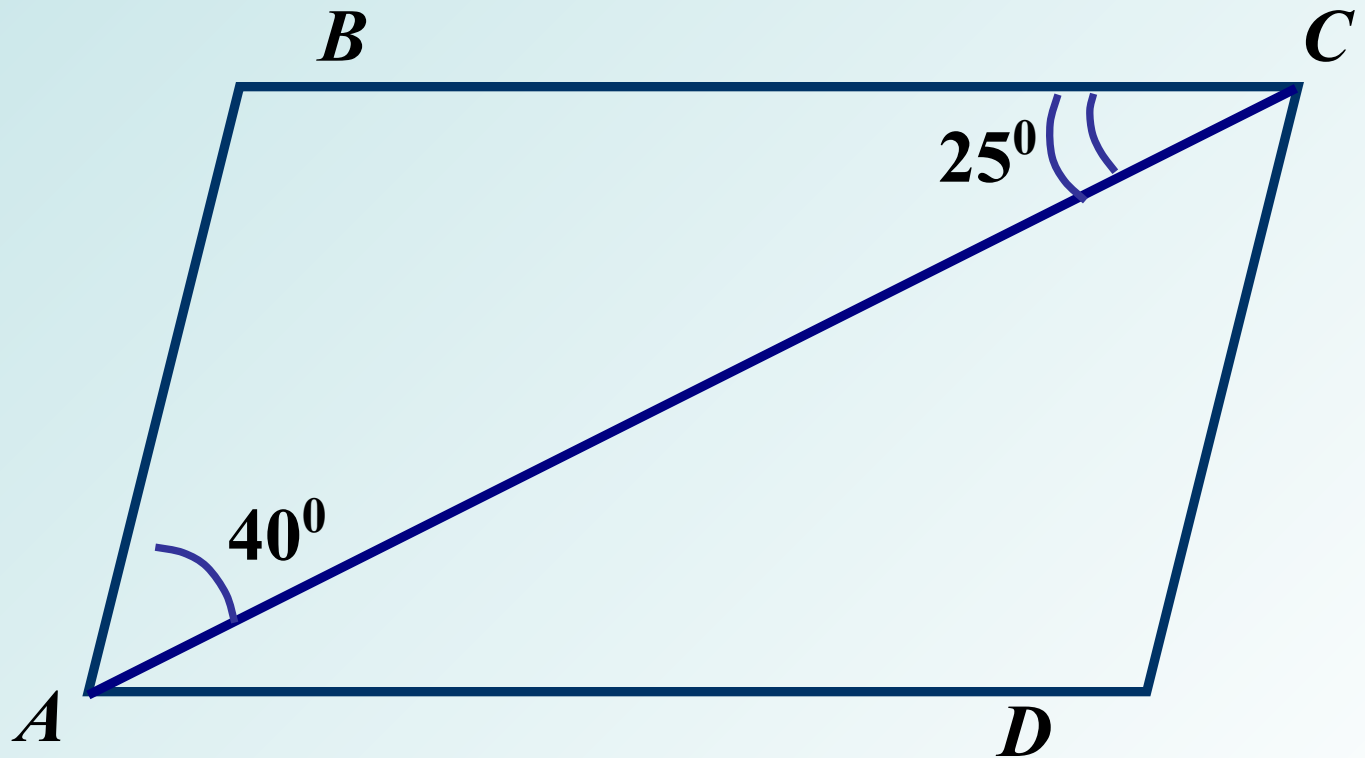

10.

Дано: $ABCD$ – параллелограмм

Найти: P_{ABCD}

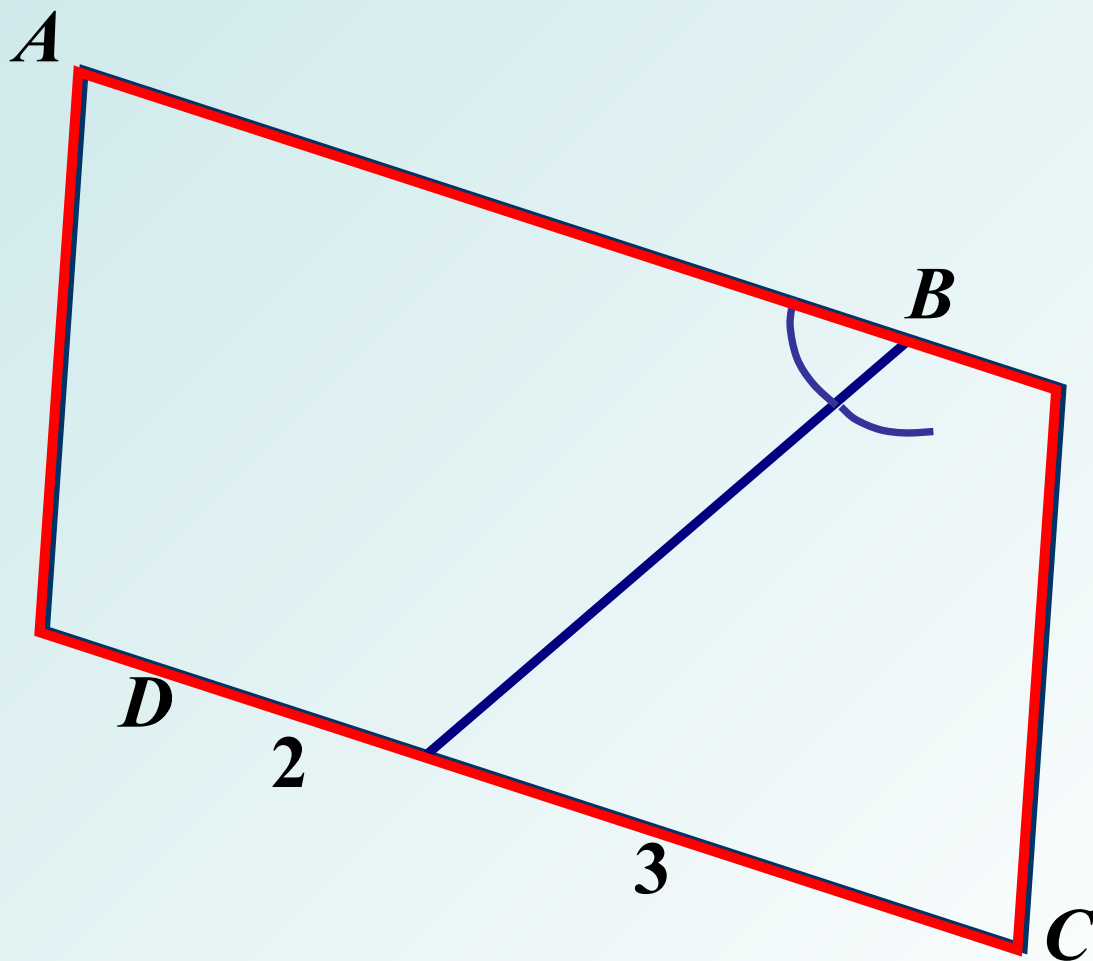

11.

Дано: $ABCD$ – параллелограмм

Найти: AD

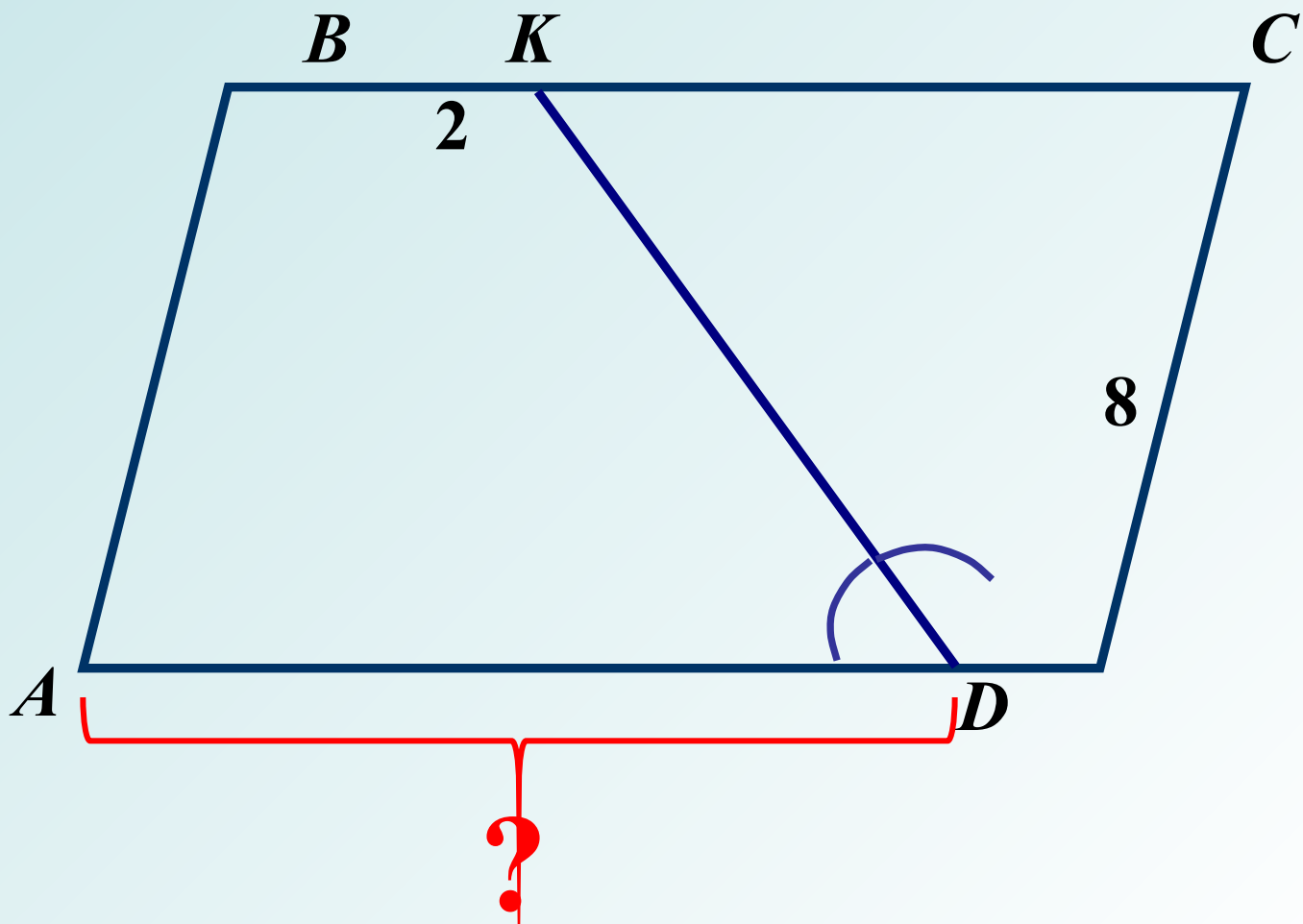

12.

Дано: $ABCD$ – параллелограмм

Найти: P_{ABCD} , $\angle AED$

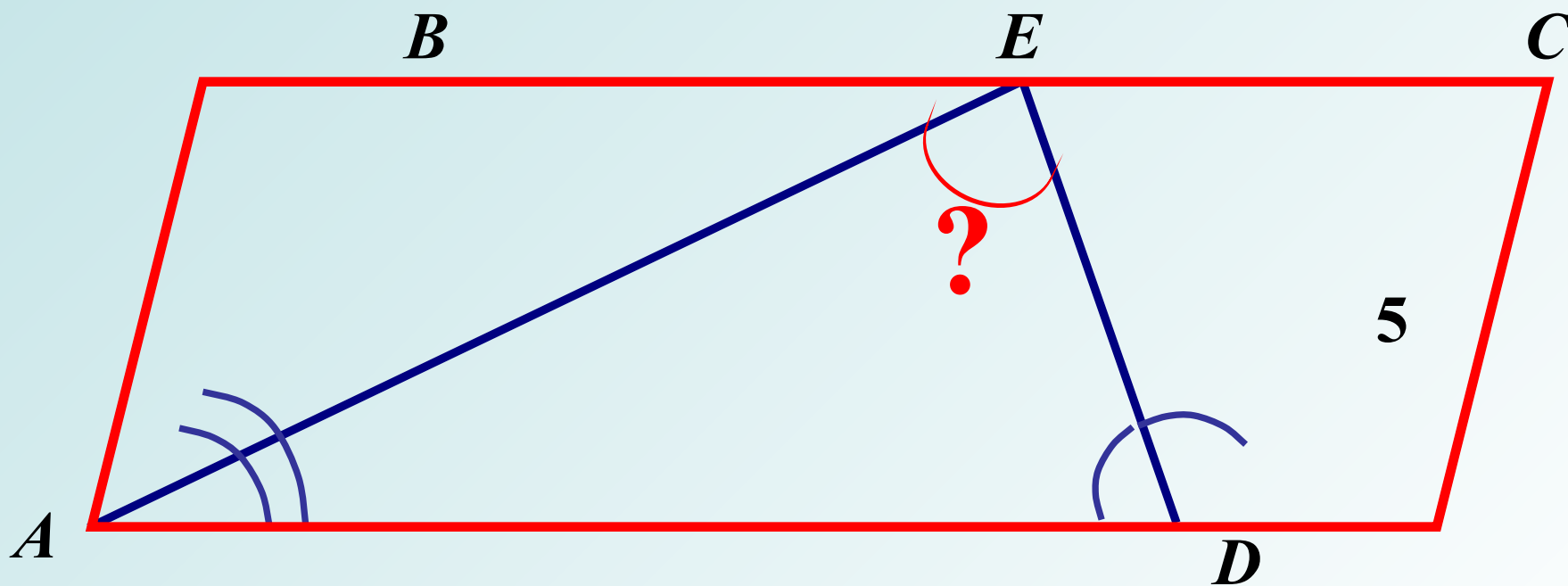

13.

Дано: $NBFD$ – параллелограмм
 $AD = 4\text{ см}$, $NB = 5\text{ см}$

Найти: BC , CD

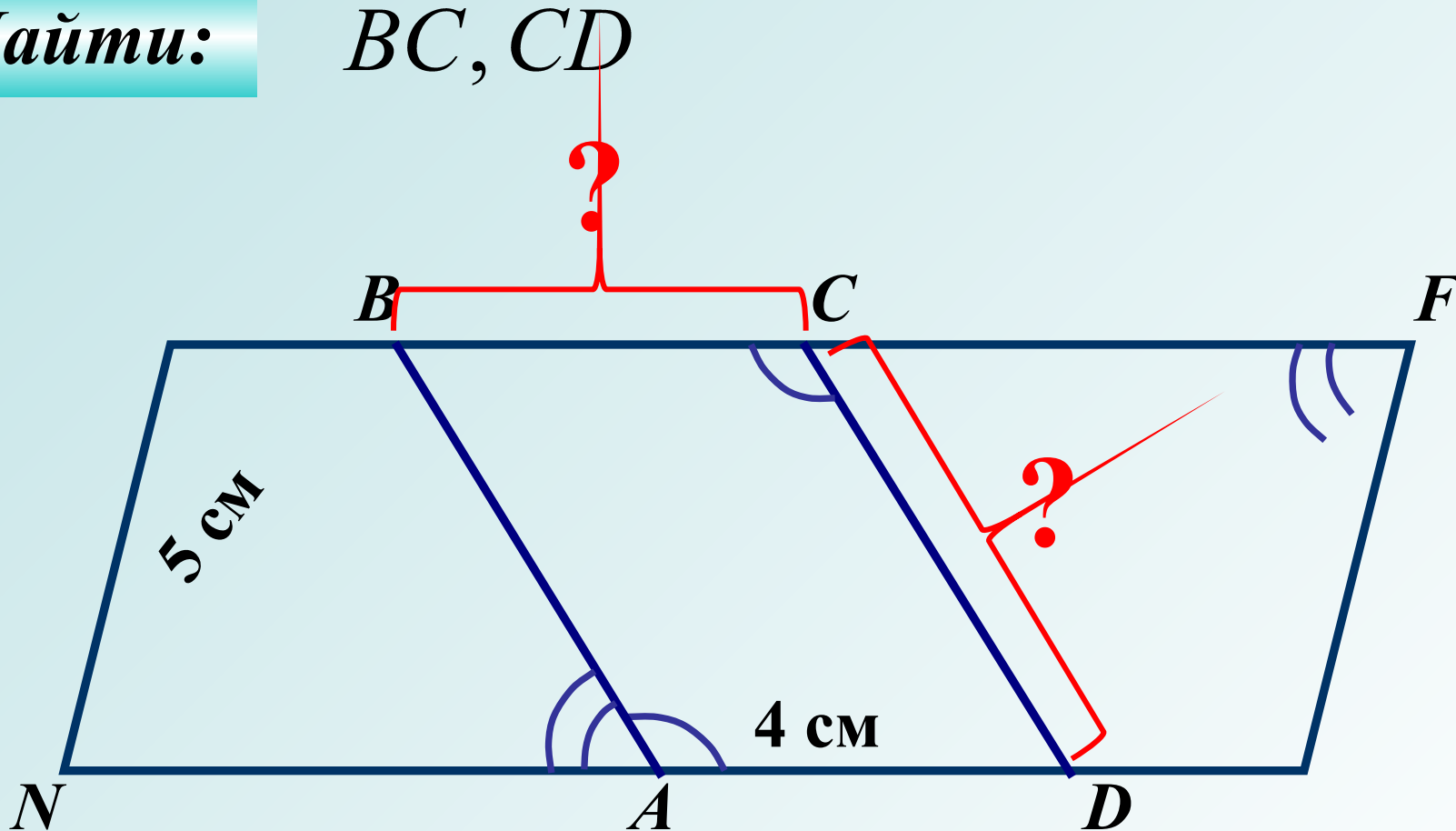

14.

Дано: $ABCD$ – параллелограмм

$$P_{MNKP} = 20 \text{ см}$$

Найти: MN, MP

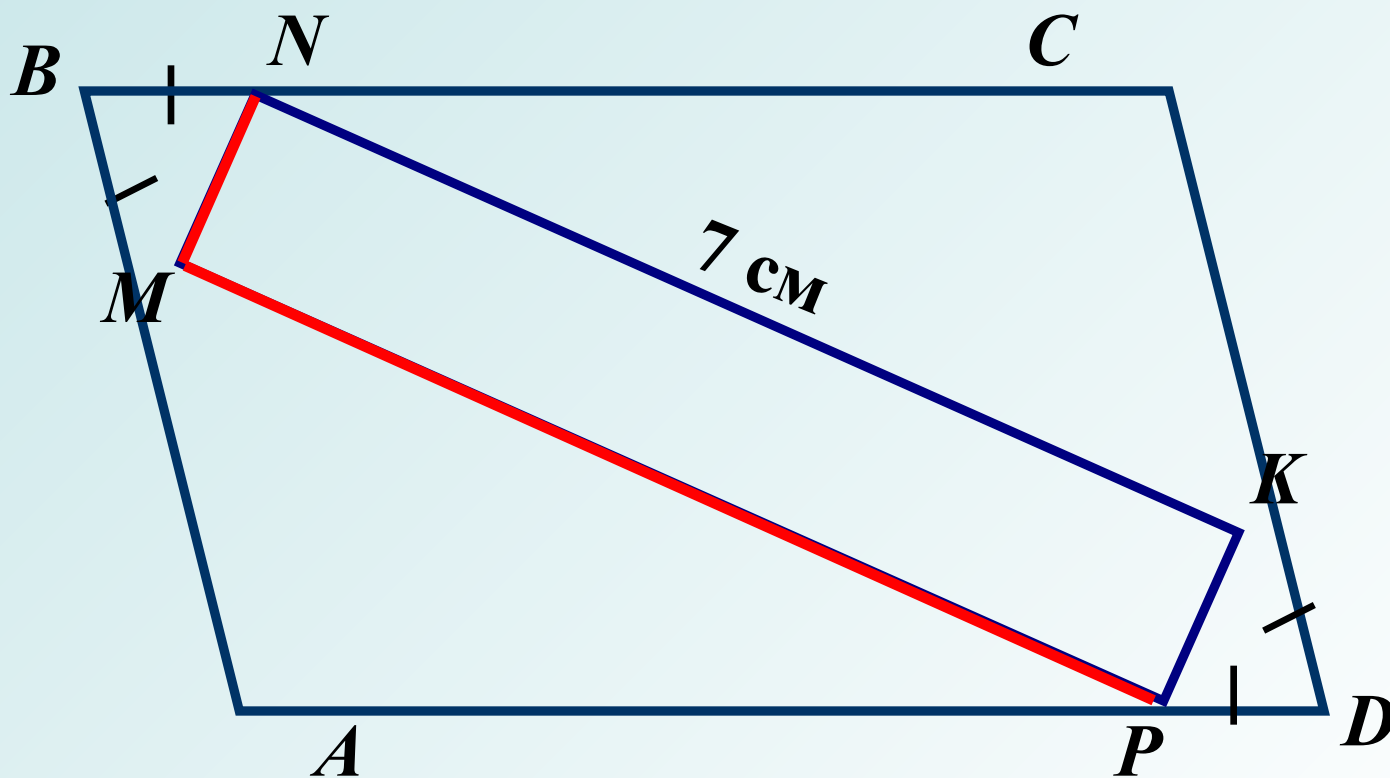

15.

Дано: $BNDM$ – параллелограмм
 $AB : BC = 4 : 5$, $P_{ABCD} = 18\sqrt{3}$

Найти: AD , DC

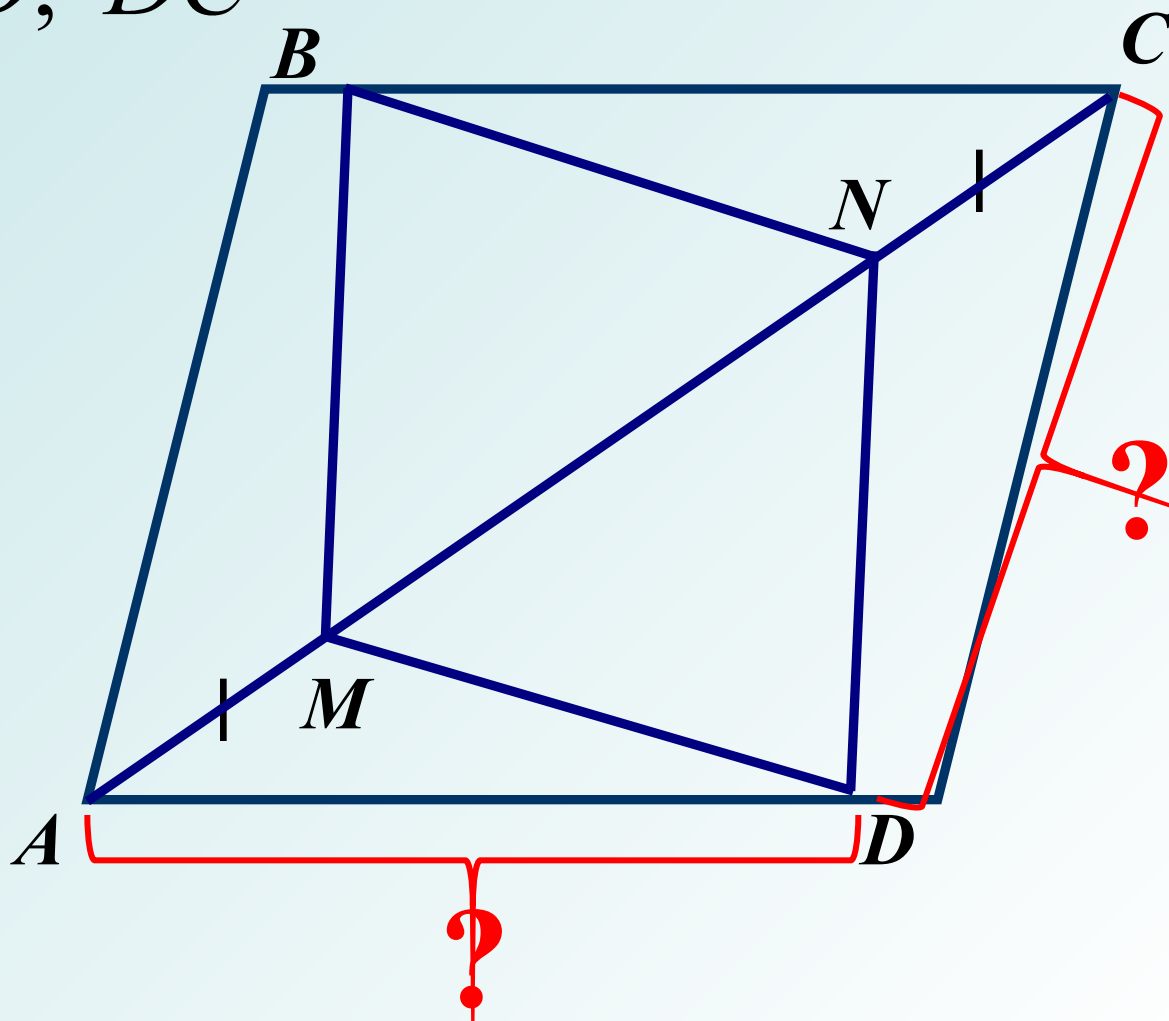

16.

Дано: $ABCD$ – трапеция

Найти: $\angle AOB$

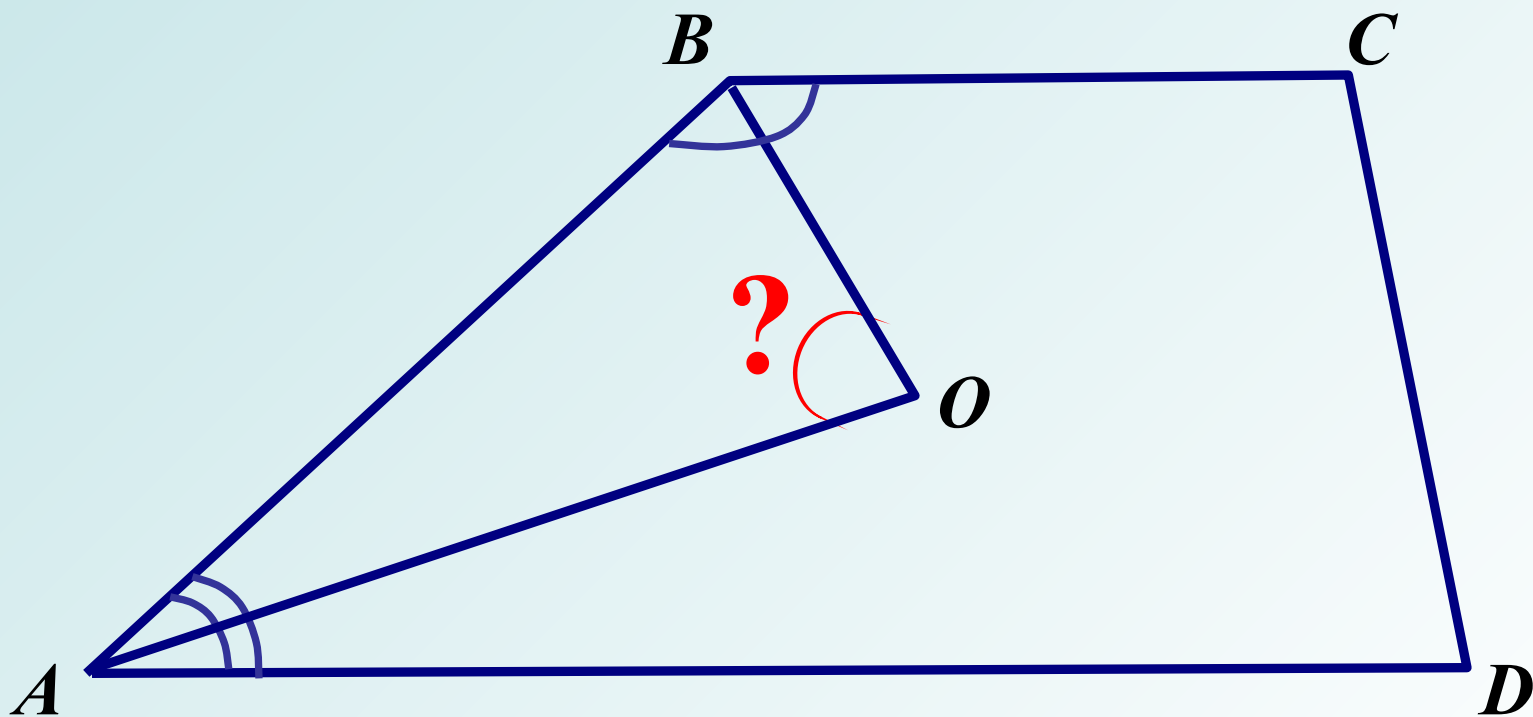

17.

Дано: $ABCD$ – трапеция

Найти: углы трапеции

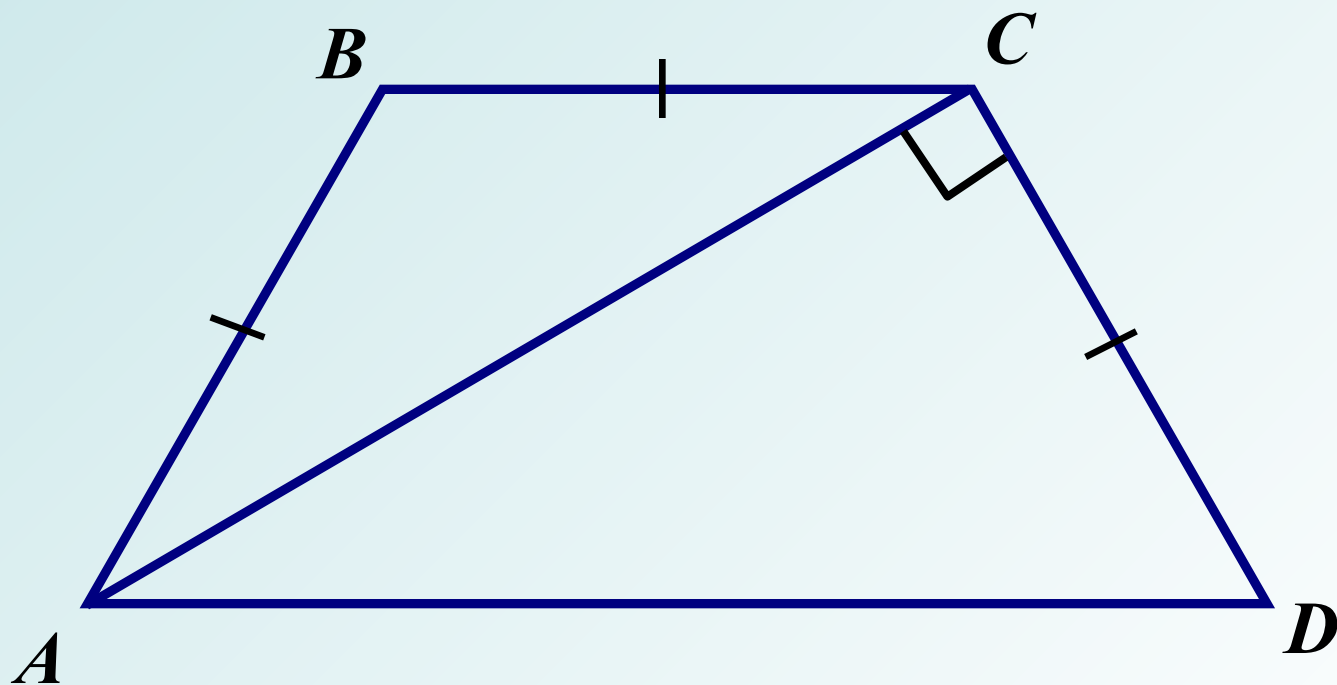

18.

Дано:

$ABCD$ – трапеция $BA\parallel CD$

Найти:

углы трапеции

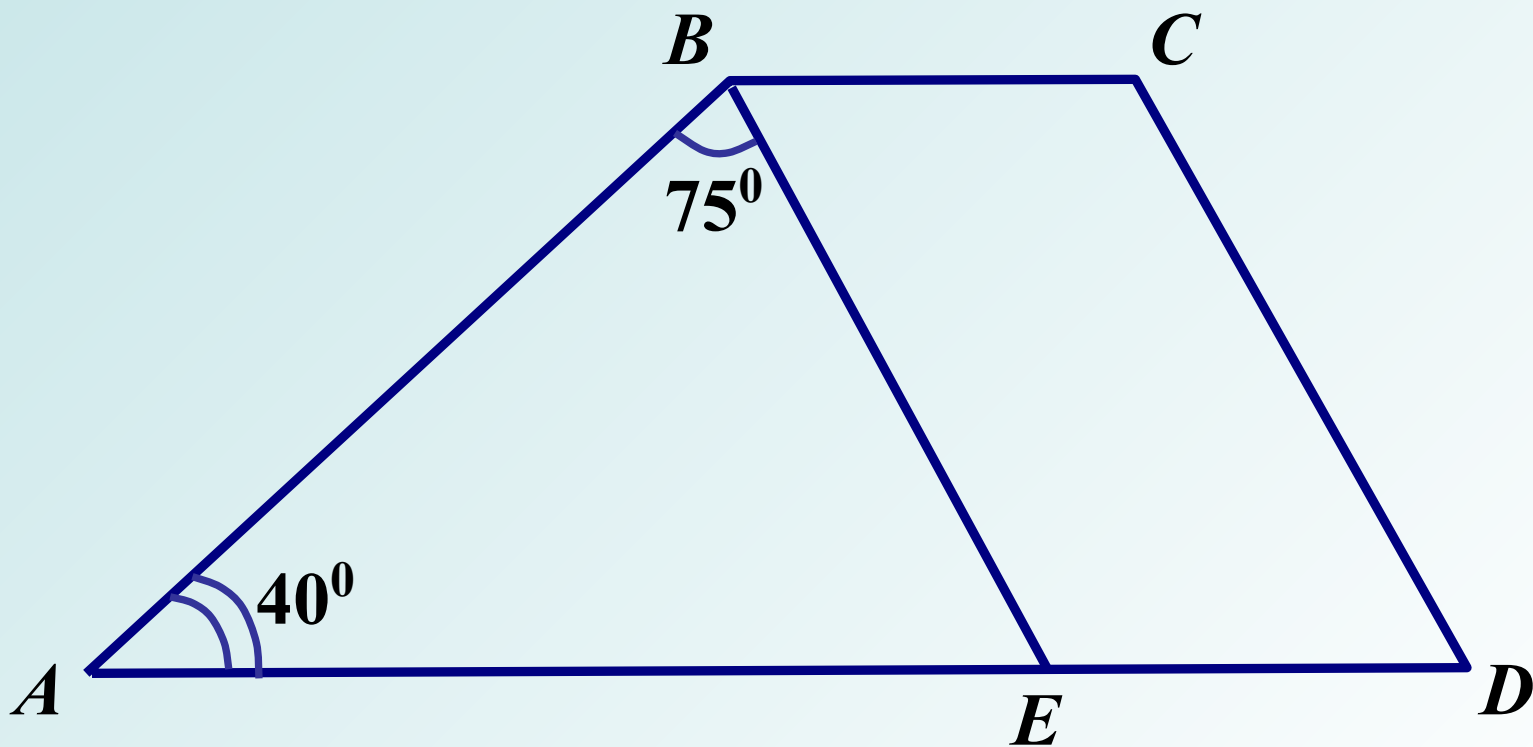

19.

Дано: $ABCD$ – трапеция

Найти: BC

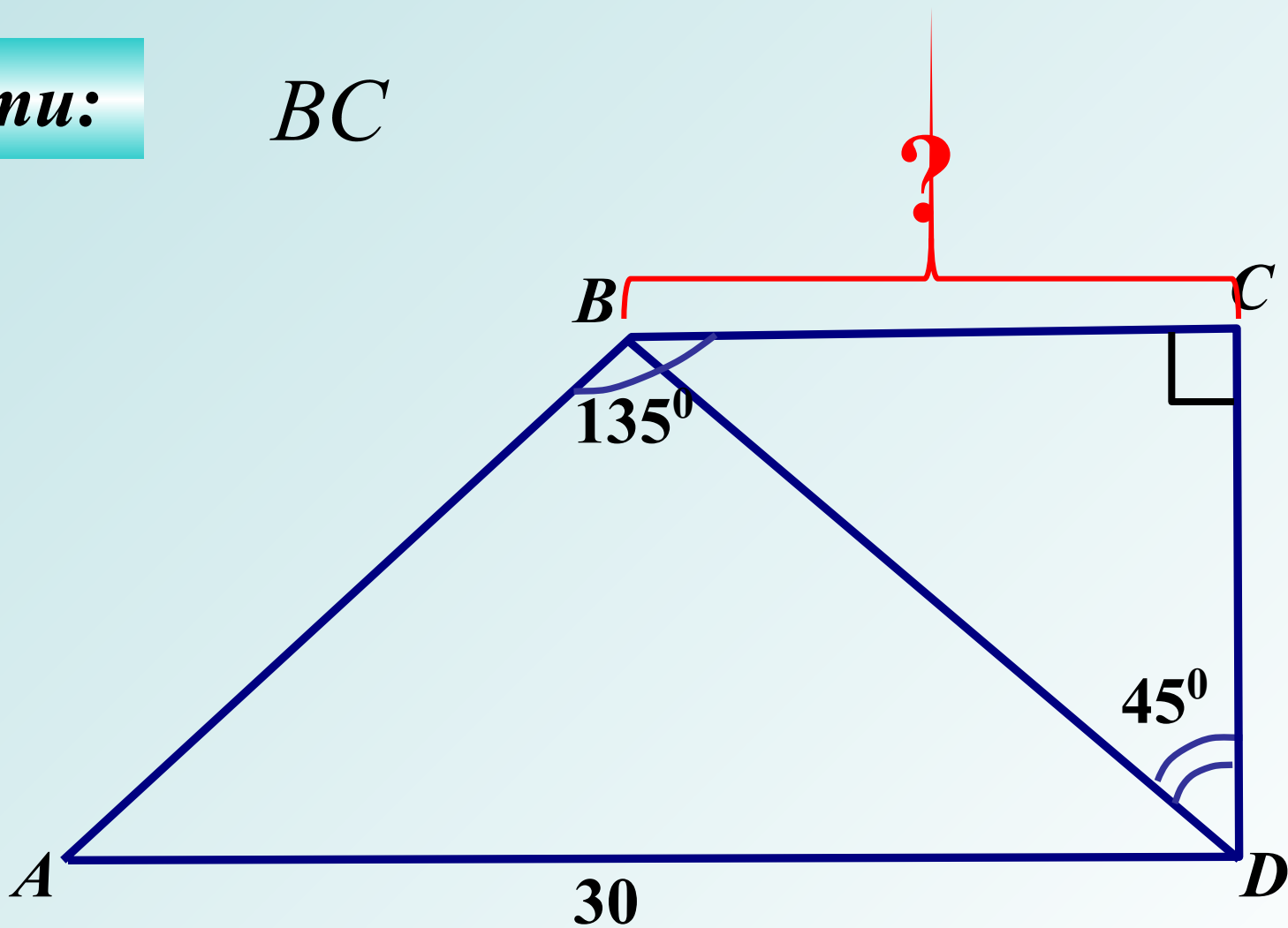

20.

Дано:

$ABCD$ – трапеция $AD = 15$

Найти:

CE

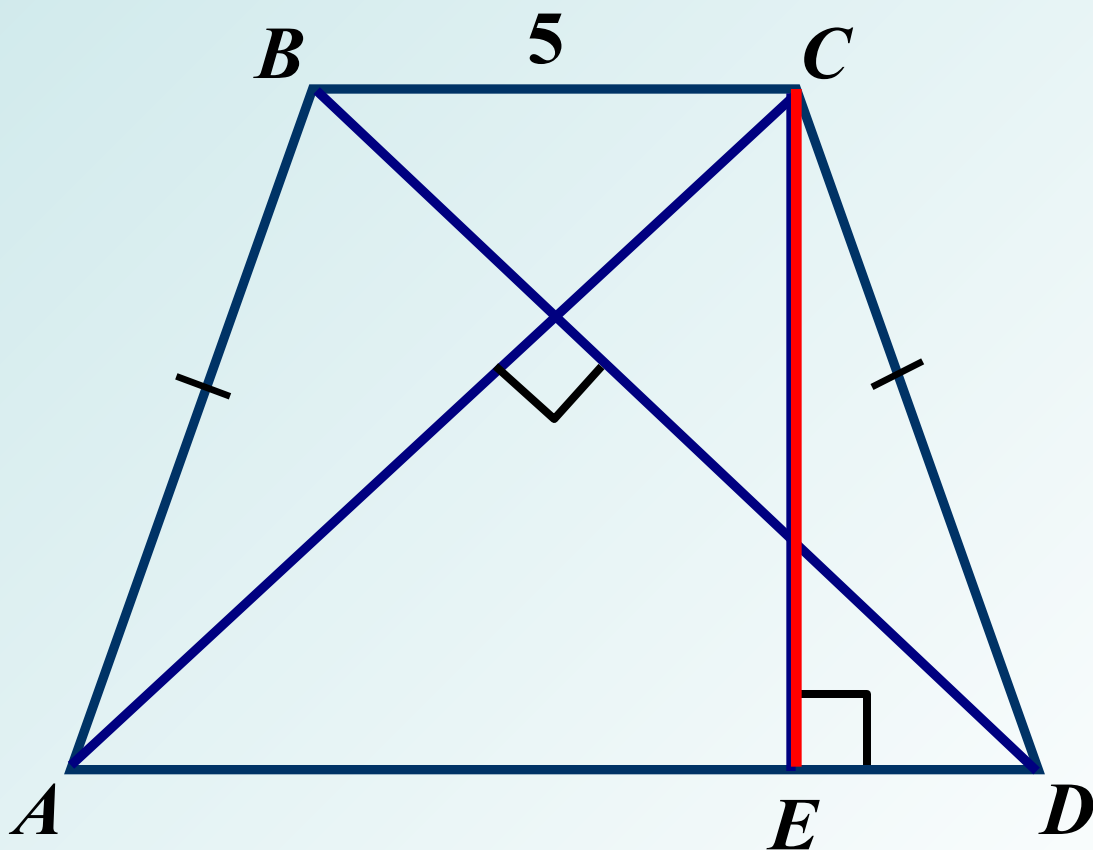

21.

Дано:

$ABCD$ – трапеция $AD = 15$

Найти:

P_{ABCD}

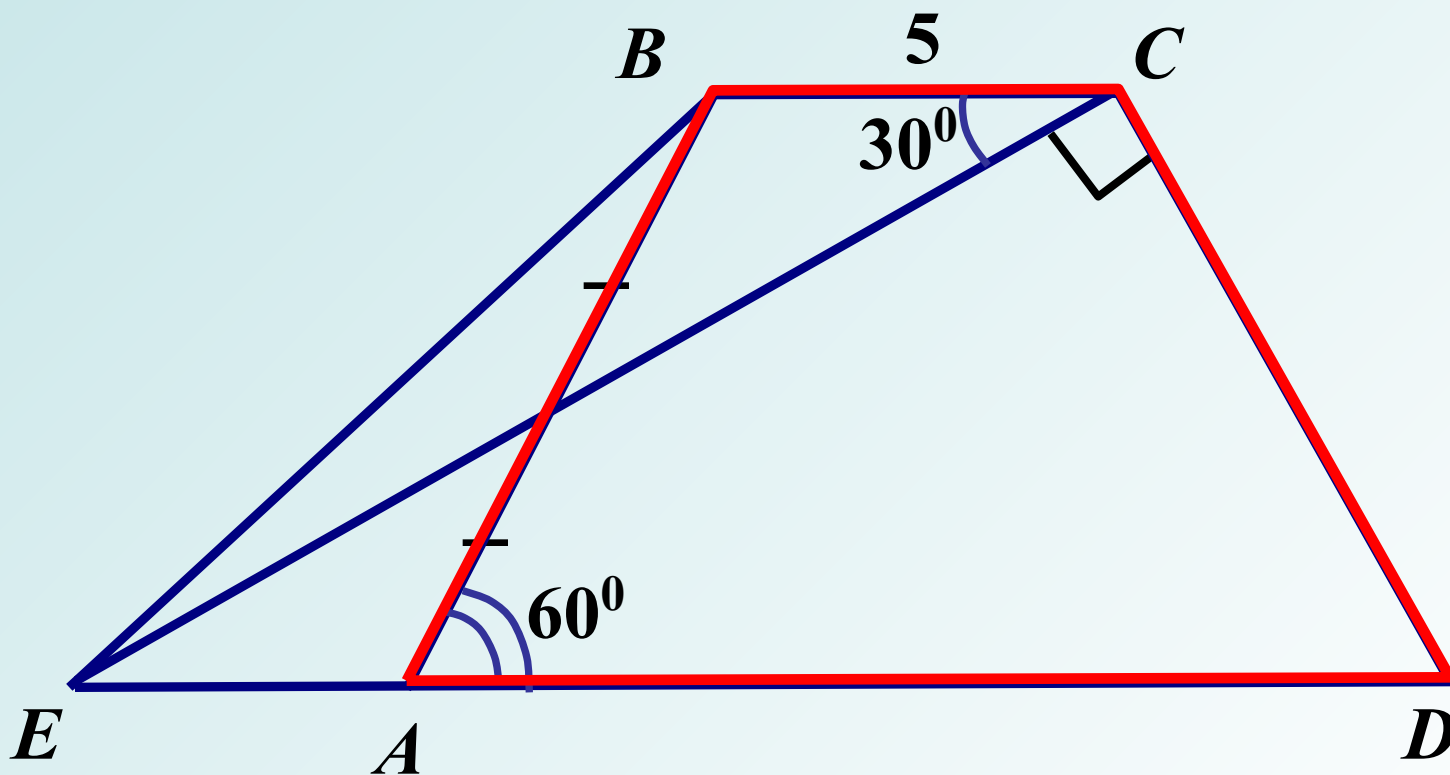

22.

Дано: $ABCM$ – трапеція $AM = 7$

Найти: CM

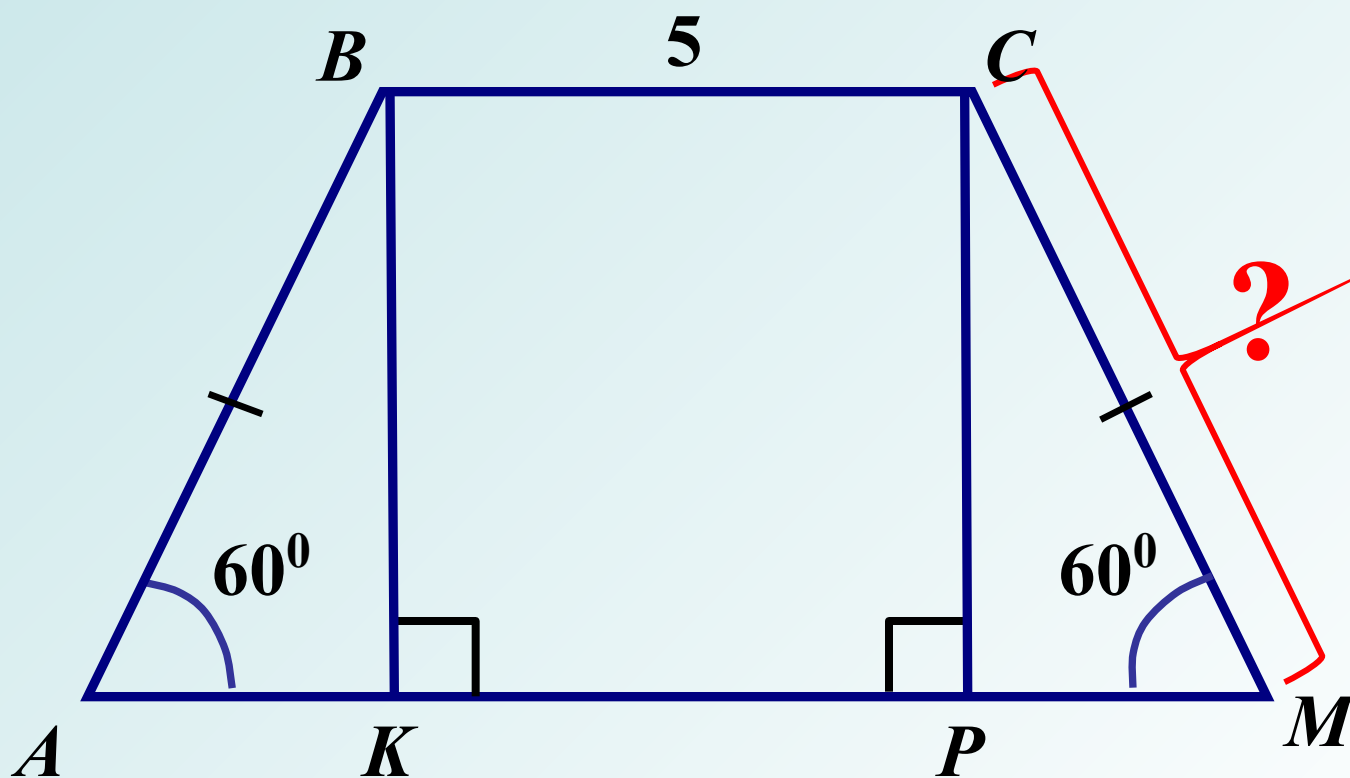

23.

Дано: $ABCD$ – трапеция

Найти: $\angle C$

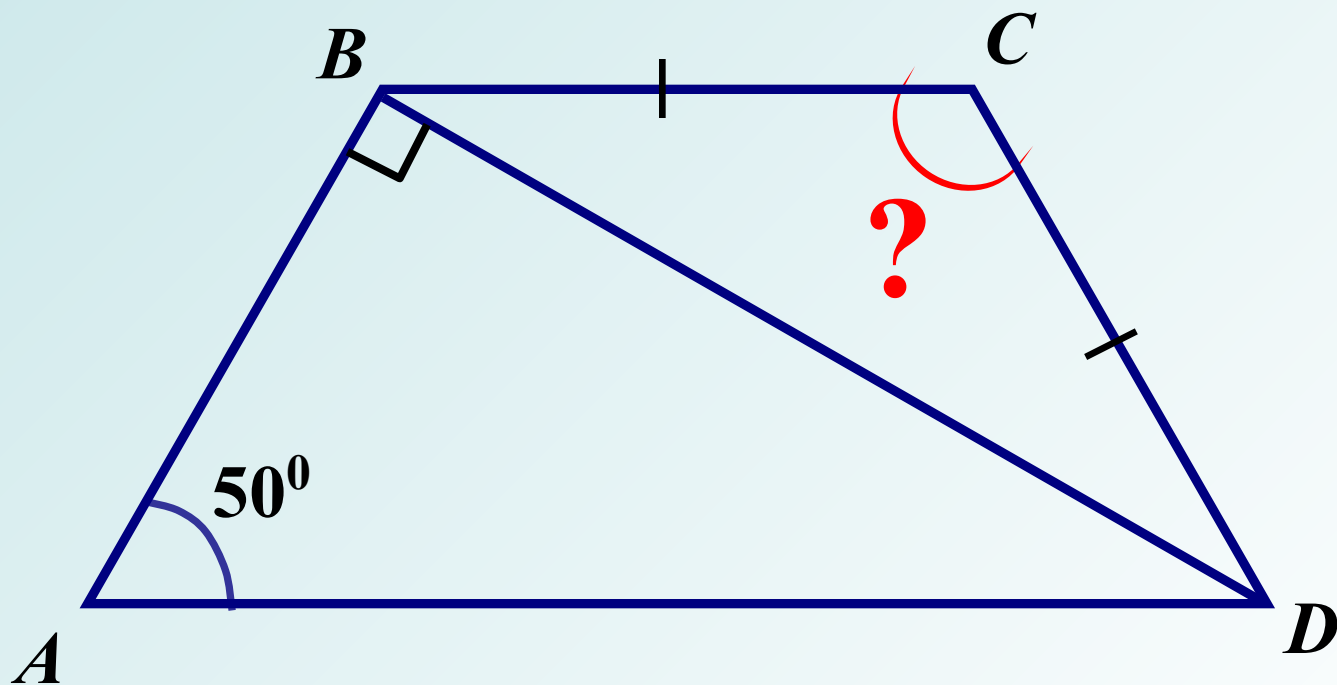

24.

Дано:

$$A_1B_1 \parallel A_2B_2 \parallel A_3B_3 \parallel A_4B_4$$
$$AA_1 = A_1A_2 = A_2A_3 = A_3A_4$$
$$AB_4 = 20 \text{ см}$$

Найти:

$$B_2B_3$$

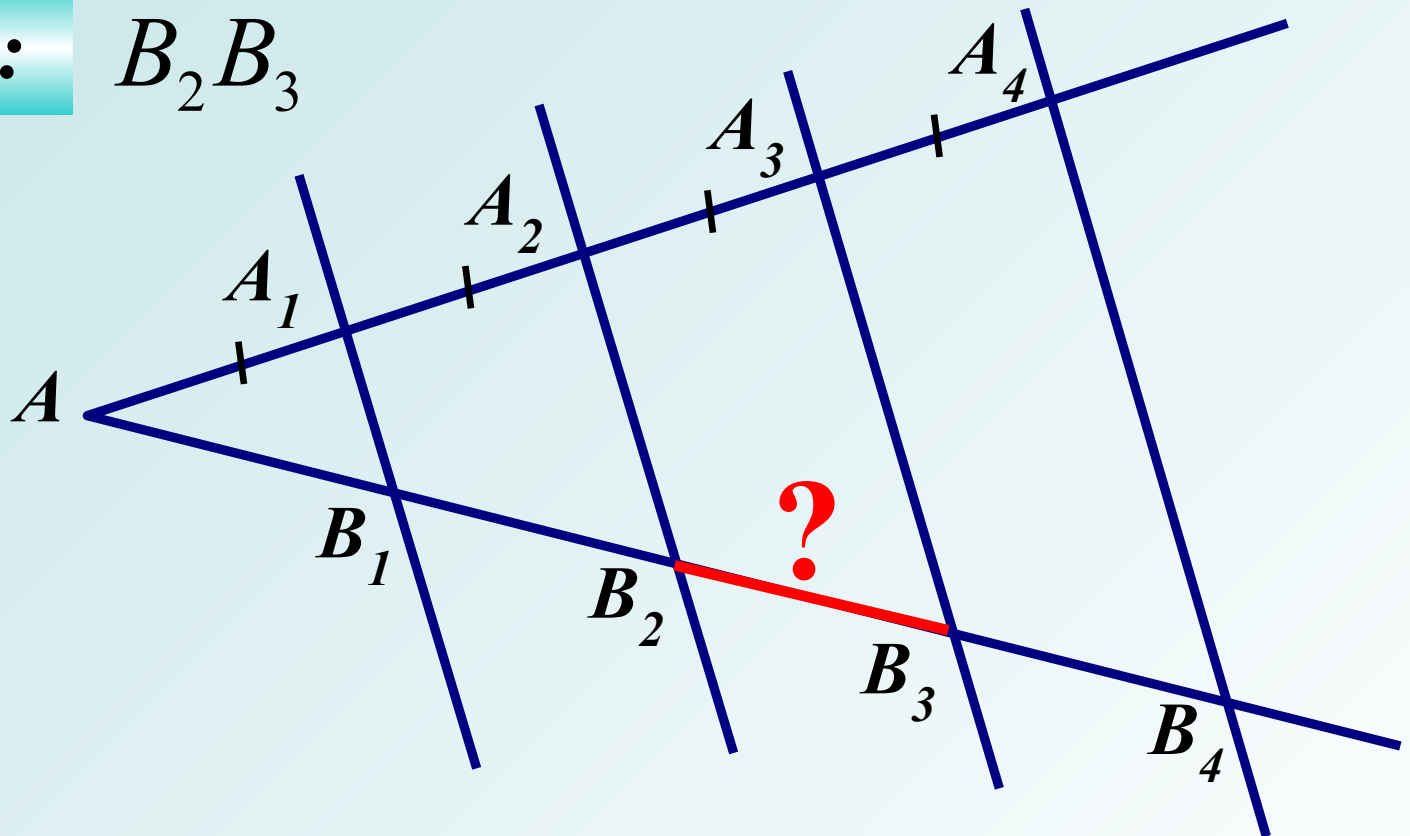

25.

Дано: $EF \parallel AC$

Найти:

P_{ABC}

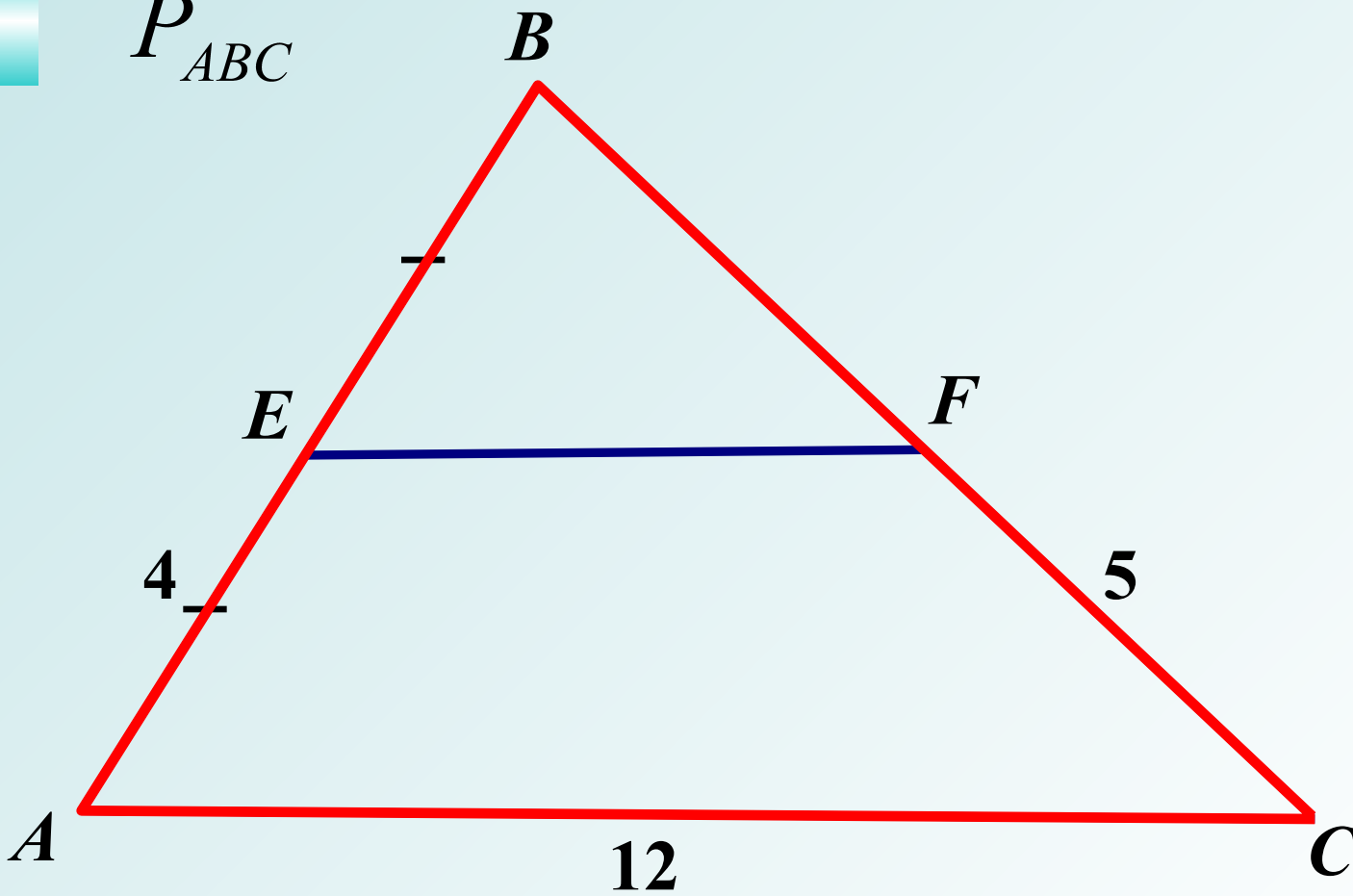

26.

Дано:

$МКПВЕПСD$, $AD = 16$

Найти:

AK

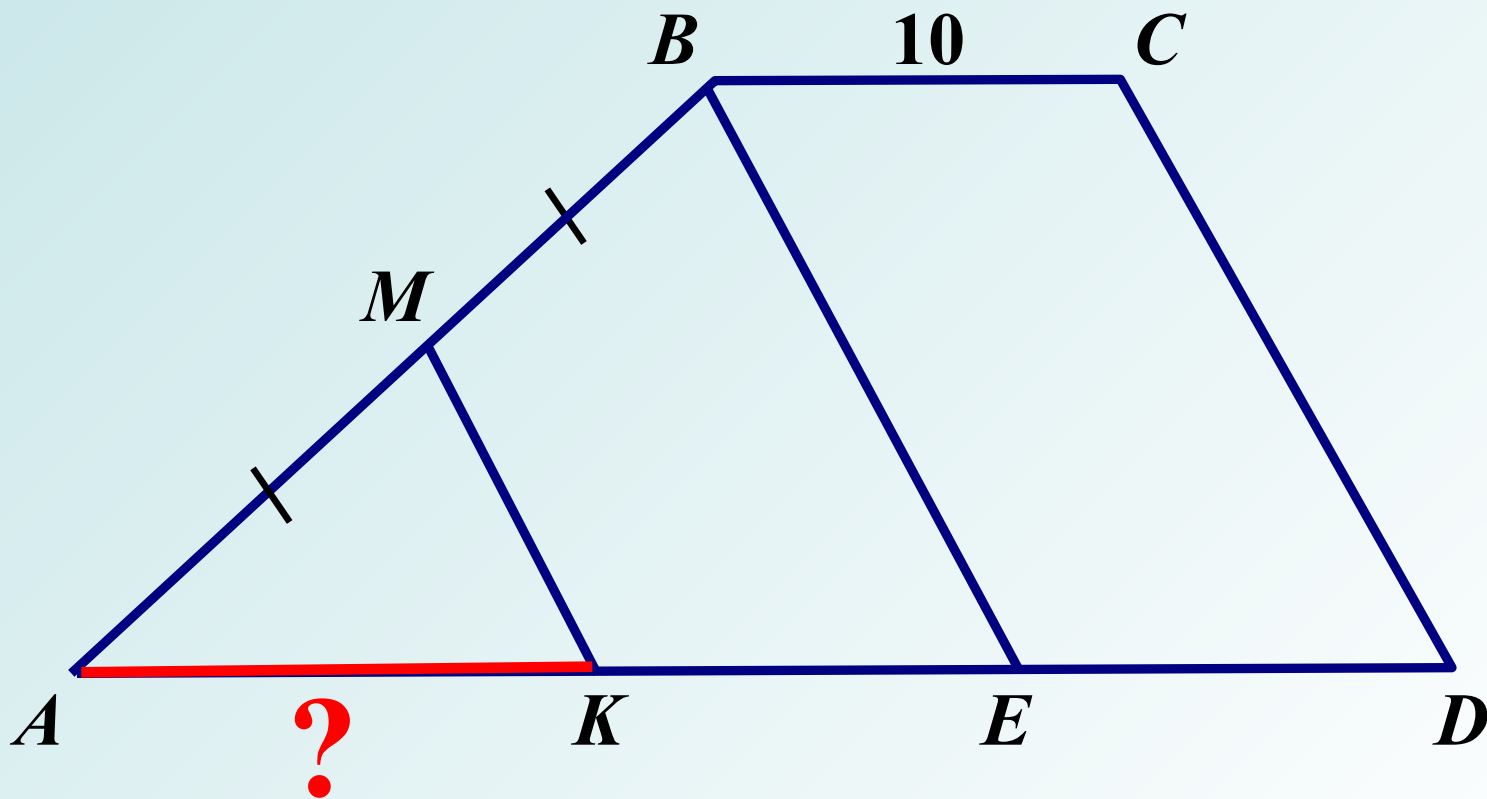

27.

Дано: $ABCD$ – *прямоугольник*

Найти: $\angle ABF$

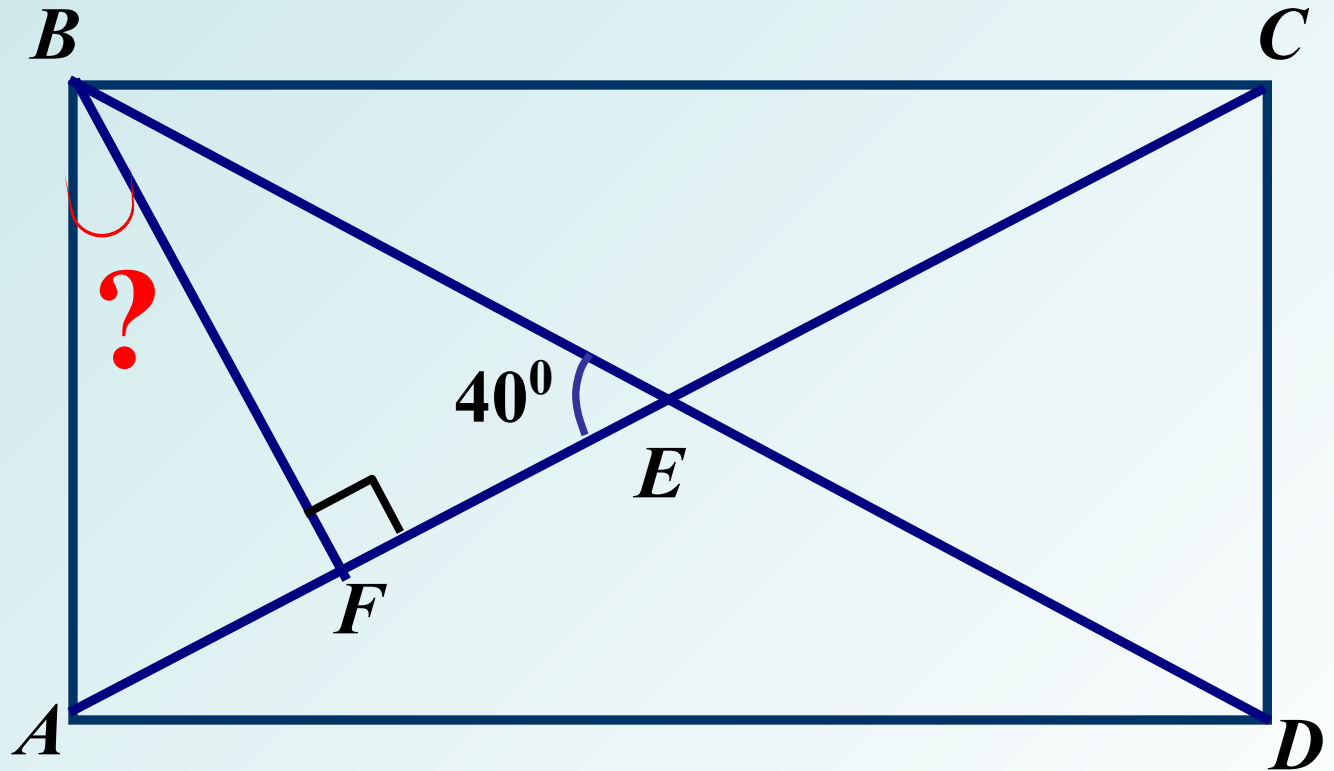

28.

Дано: $АСЕК$ – прямоугольник
 $BC = 5\text{ см}$

Найти: P_{BDFM}

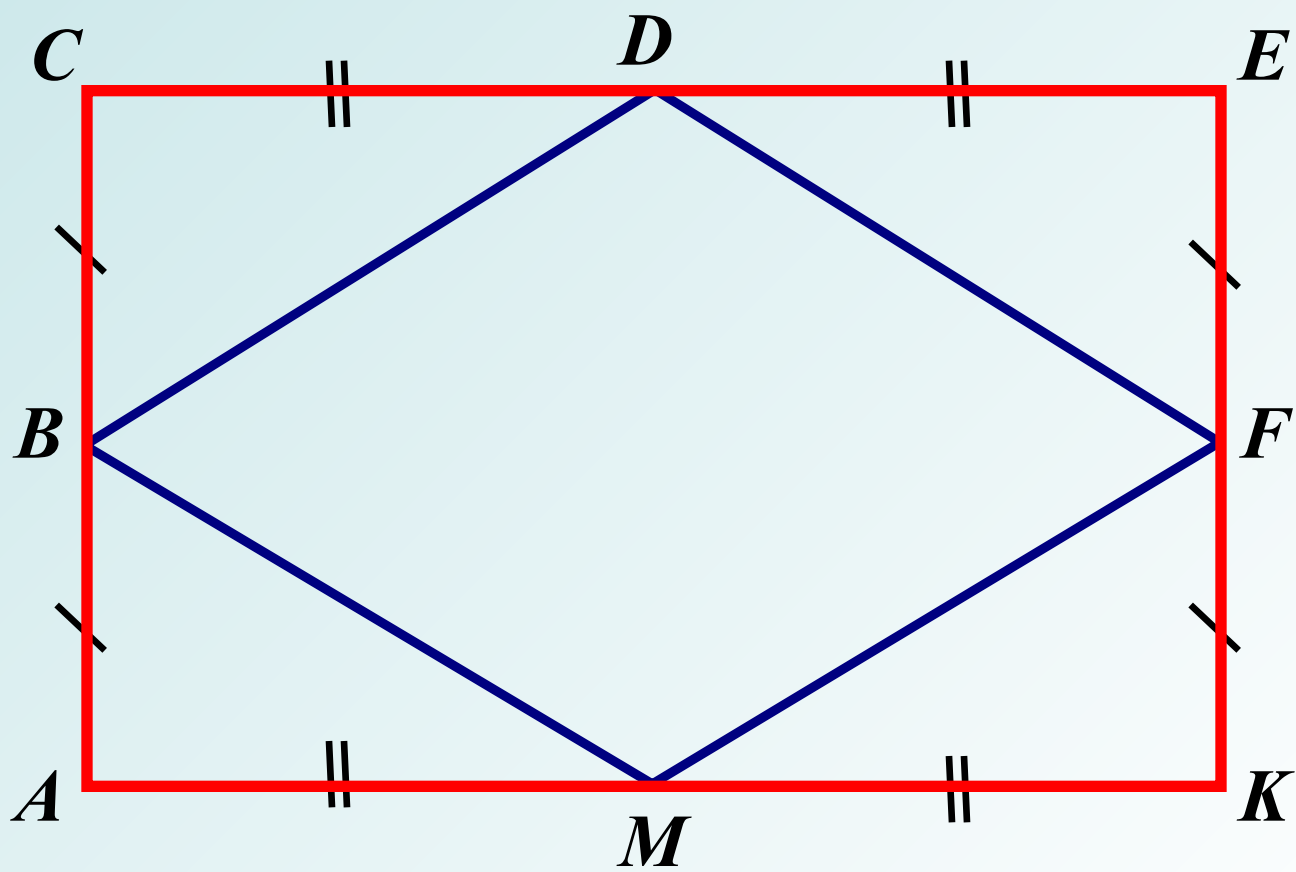

29.

Дано: $ABCD$ – прямоугольник

Найти: $\angle AOO$, $\angle BOC$

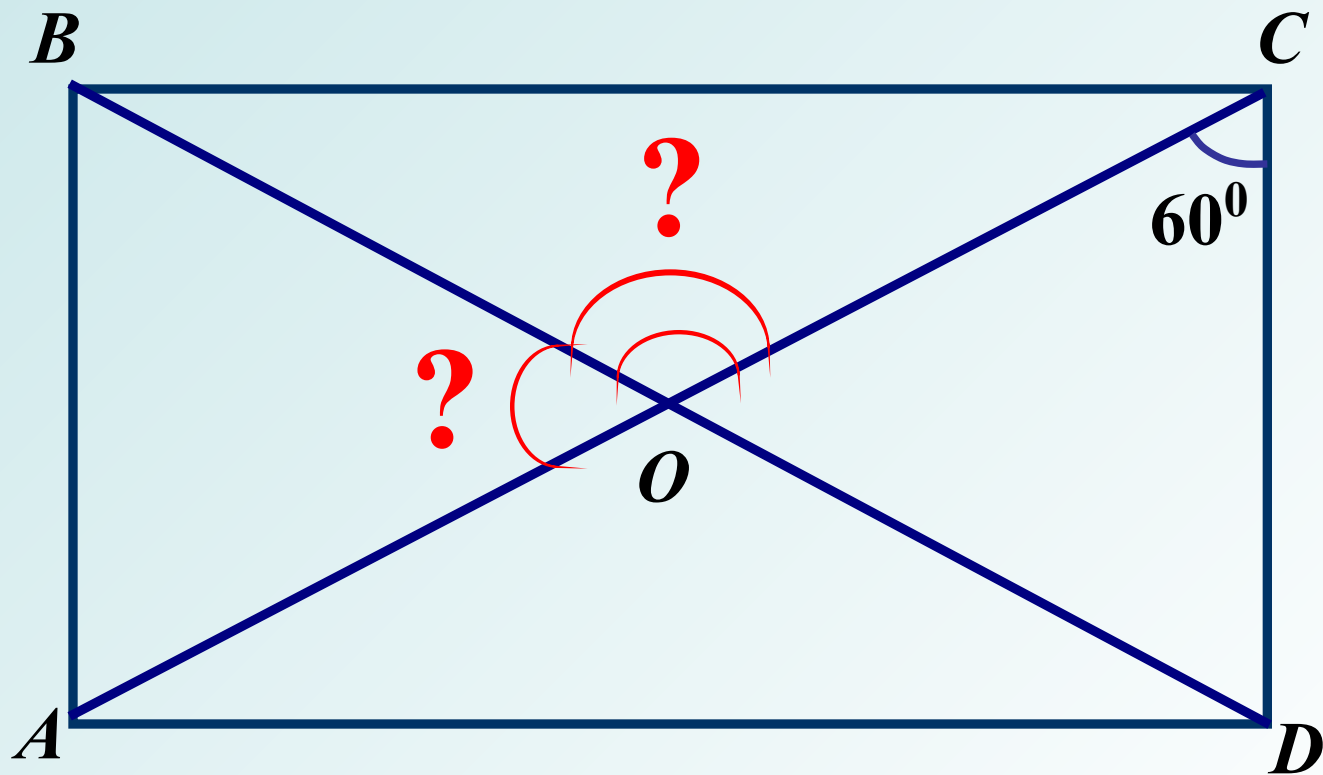

30.

Дано: $ABCD$ – прямоугольник

Найти: AC , AB

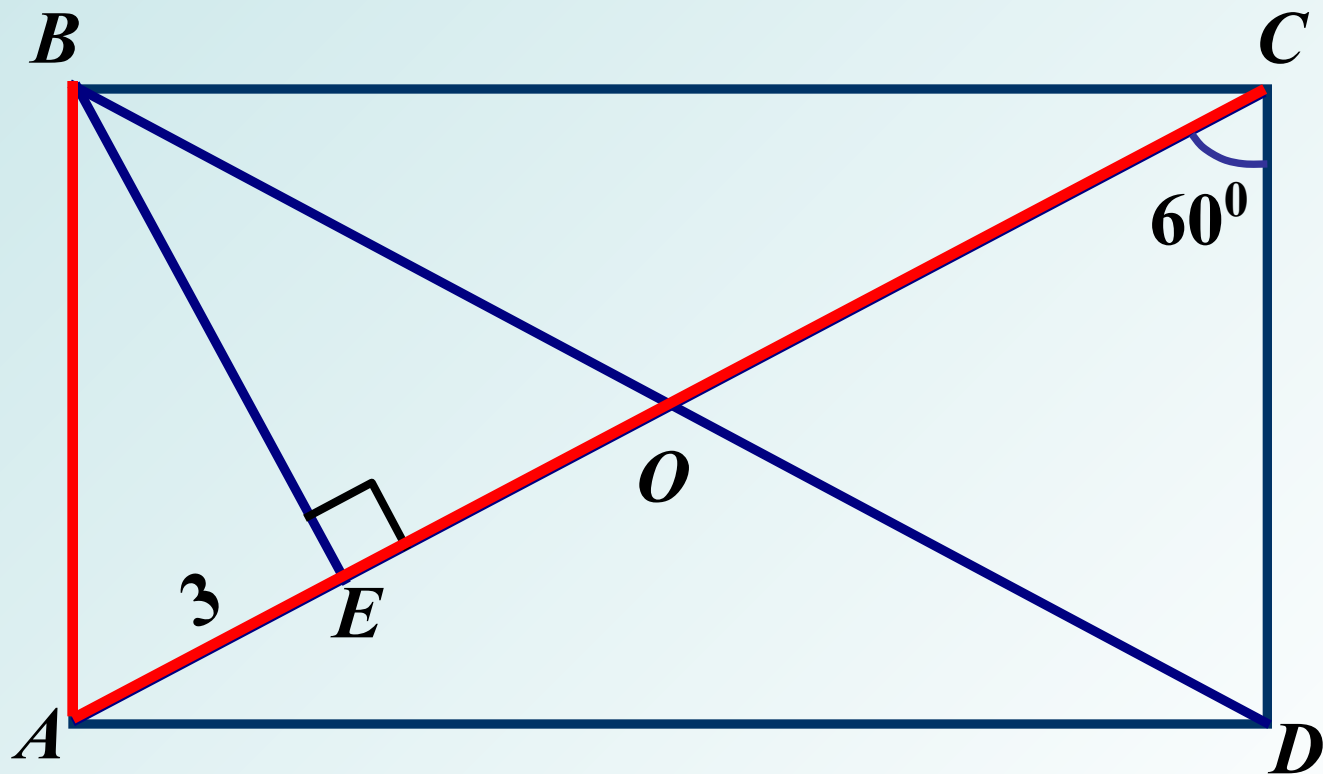

31.

Дано: $ABCD$ – прямоугольник

Найти: AD

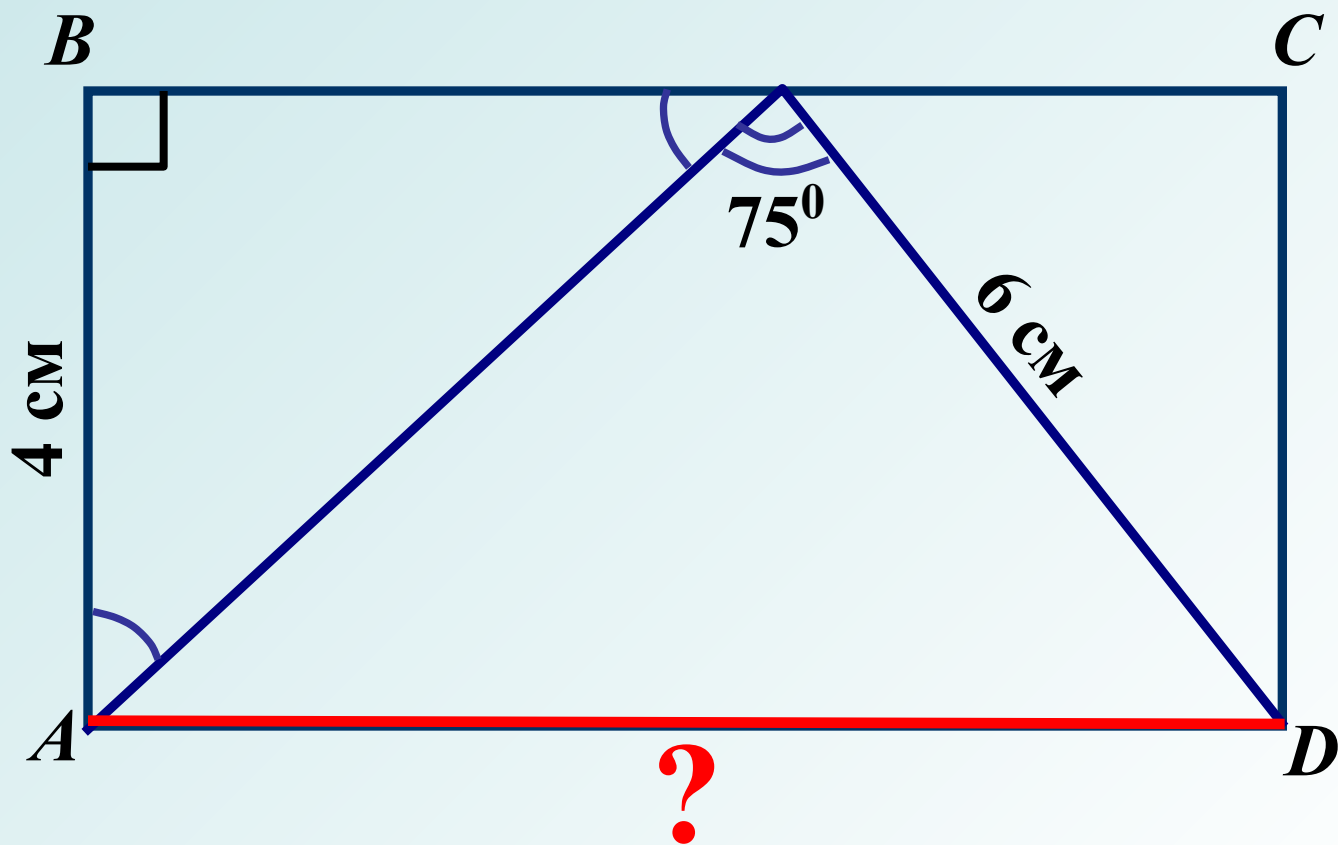

32.

Дано: $ABCD$ – ромб

Найти: $MD + DN$

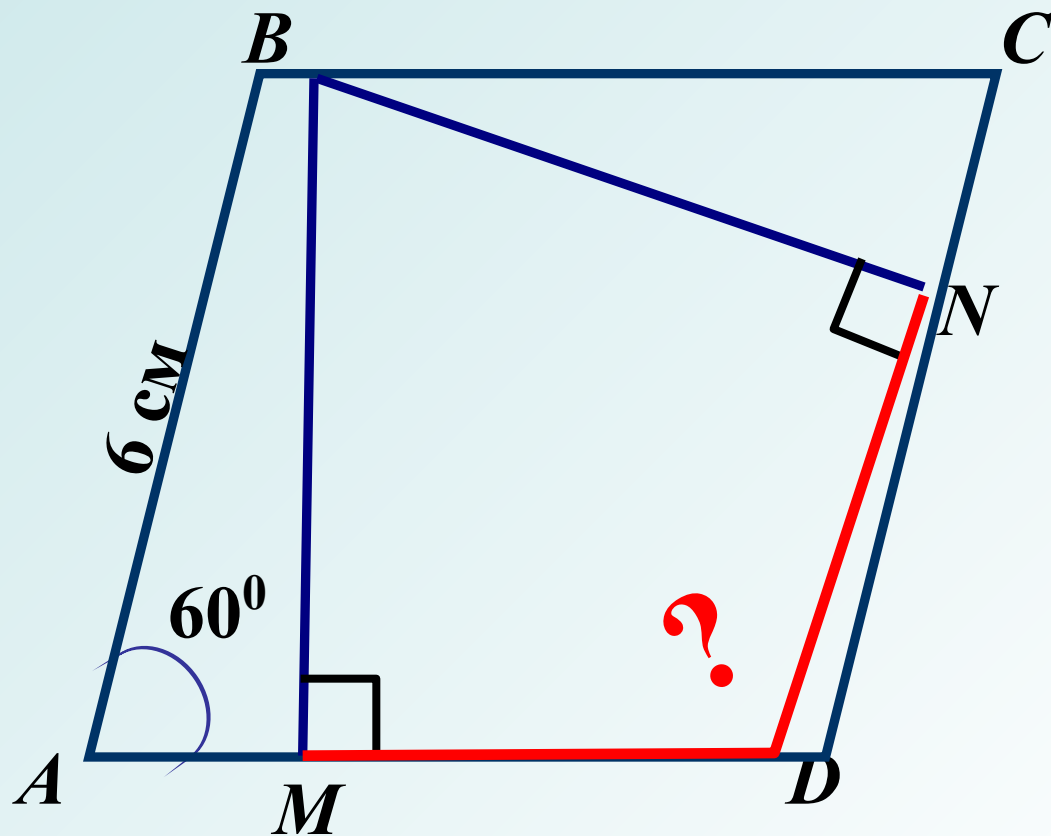

33.

Дано: $ABCD$ – ромб

Найти: $\angle CBE$

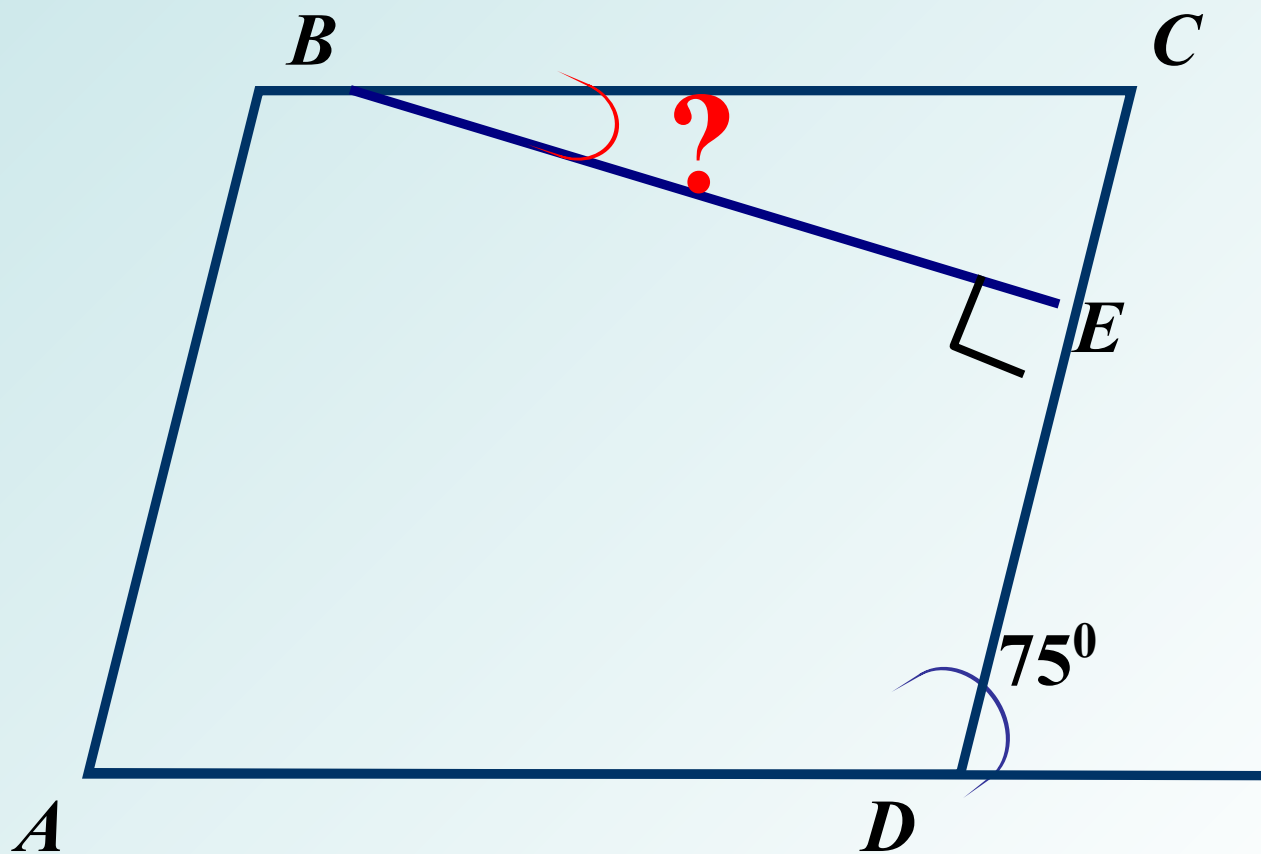

34.

Дано: $ABCD$ – ромб

Найти: $\angle BAA$

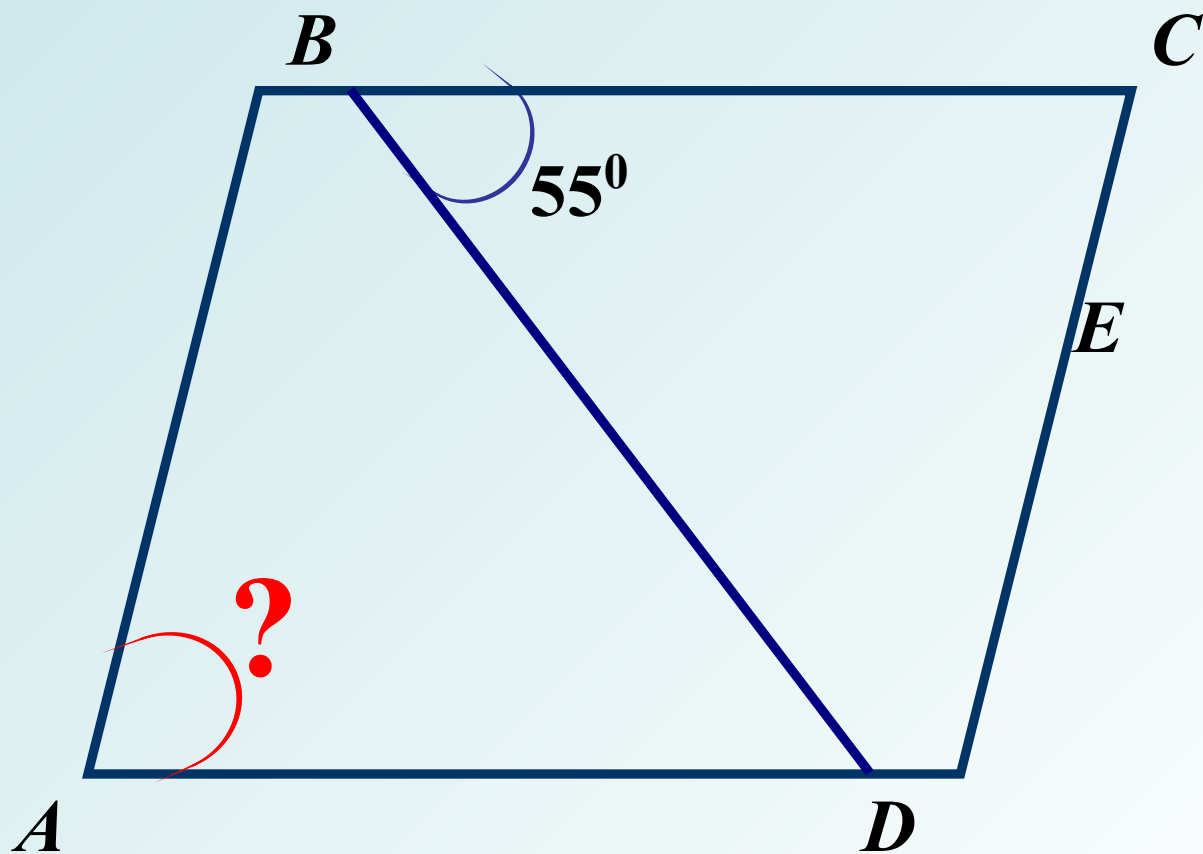

35.

Дано: $ABCD$ – ромб

Найти: $\angle ABC$

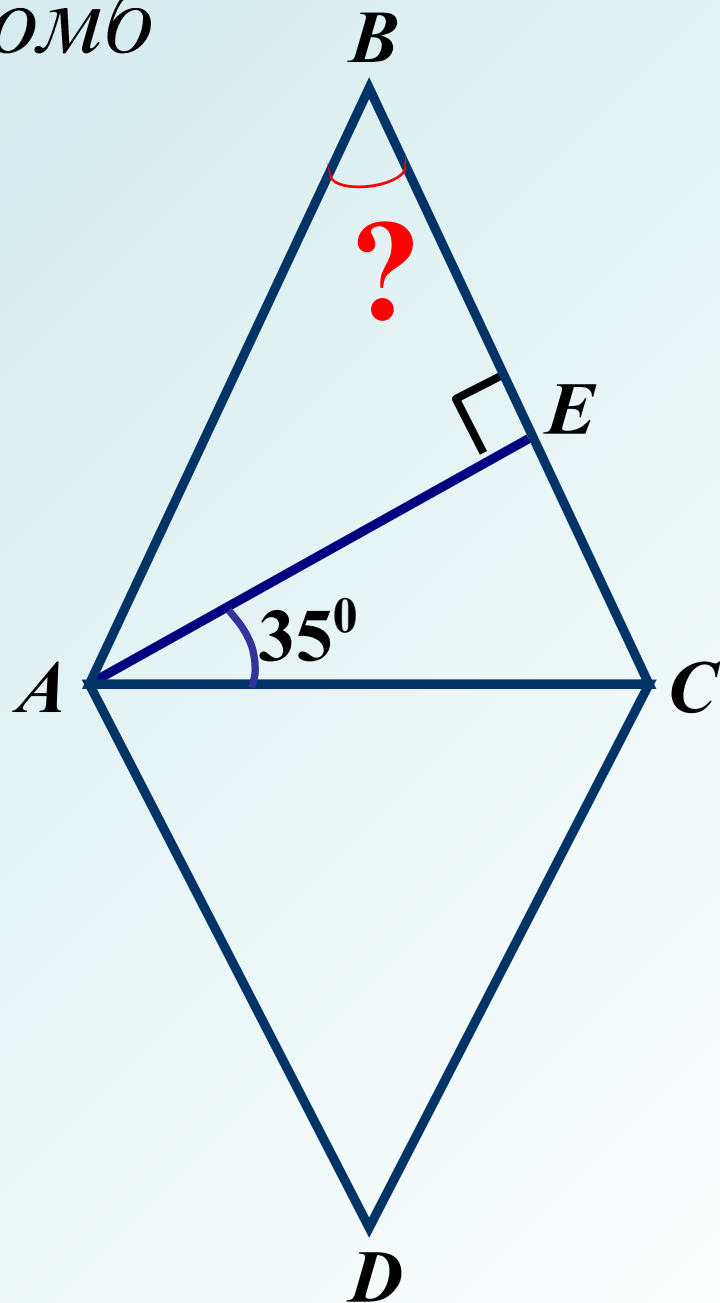

36.

Дано:

$ABCD$ – квадрат

$$PK = 2\text{ см}, AK = \sqrt{3}$$

Найти:

$$P_{ABCD}$$

