

TEMA 6

СОДЕРЖАНИЕ

- **Основы теории МОМ метода**
- **Настройка параметров EM симулятора на основе метода МОМ**
- **Анализ моделирования устройства на основе технологии МОМ**

МЕТОД МОМЕНТОВ

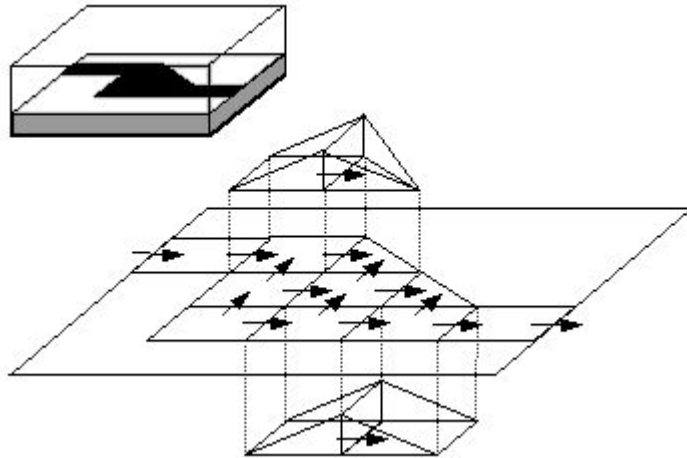

$$\iint dS \bar{\bar{G}}(r, r') \cdot J(r) = E(r)$$

$$J(r) \approx \sum_{j=1}^N I_j B_j(r)$$

МЕТОД МОМЕНТОВ

$$\sum_{i=1}^N Z_{i,j} I_j = V_i \quad \text{or} \quad [Z] \cdot [I] = [V]$$

$$Z_{i,j} = \iint_S dS \mathbf{B}_i(\mathbf{r}) \cdot \iint_{S'} dS' \bar{\mathbf{G}}(\mathbf{r}, \mathbf{r}') \cdot \mathbf{B}_j(\mathbf{r}')$$

$$V_i = \iint_S dS \mathbf{B}_i(\mathbf{r}) \cdot \mathbf{E}(\mathbf{r})$$

$$\bar{\mathbf{G}}(\mathbf{r}, \mathbf{r}') = j\omega G^A(\mathbf{r}, \mathbf{r}') \bar{\mathbf{I}} - \frac{1}{j\omega} \nabla [G^V(\mathbf{r}, \mathbf{r}') \nabla \cdot]$$

$$Z_{i,j} = j\omega L_{i,j} + \frac{1}{j\omega C_{i,j}}$$

$$L_{i,j} = \iint_S dS \mathbf{B}_i(\mathbf{r}) \cdot \iint_{S'} dS' G^A(\mathbf{r}, \mathbf{r}') \mathbf{B}_j(\mathbf{r}')$$

$$\frac{1}{C_{i,j}} = \iint_S dS \nabla \cdot \mathbf{B}_i(\mathbf{r}) \iint_{S'} dS' G^V(\mathbf{r}, \mathbf{r}') \nabla \cdot \mathbf{B}_j(\mathbf{r}')$$

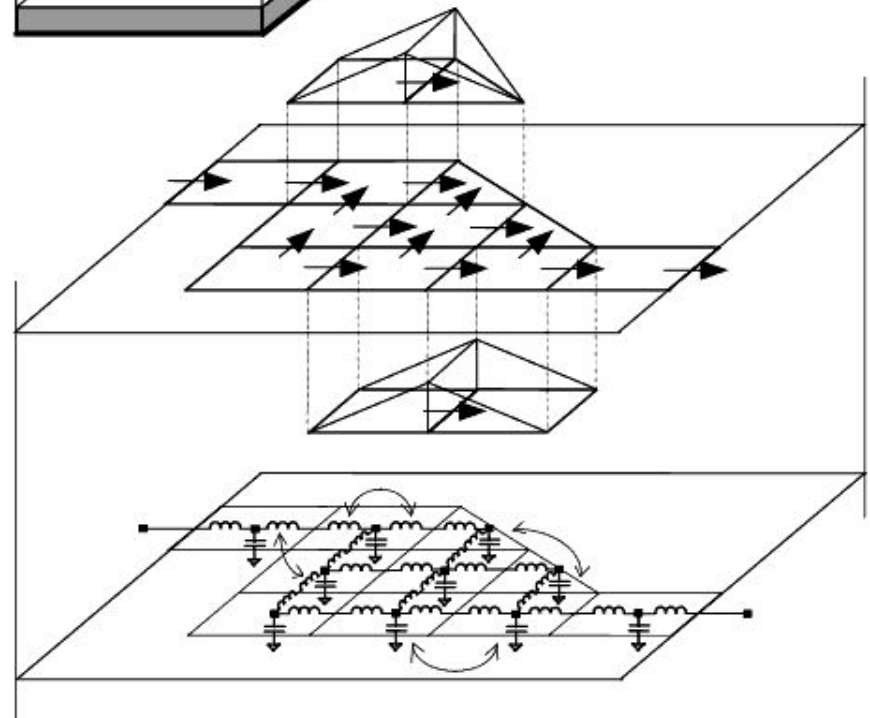
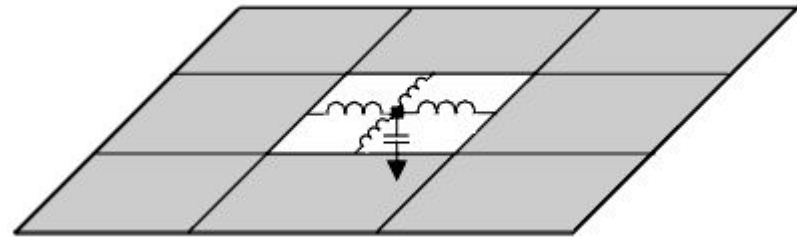

direct excitation point feed

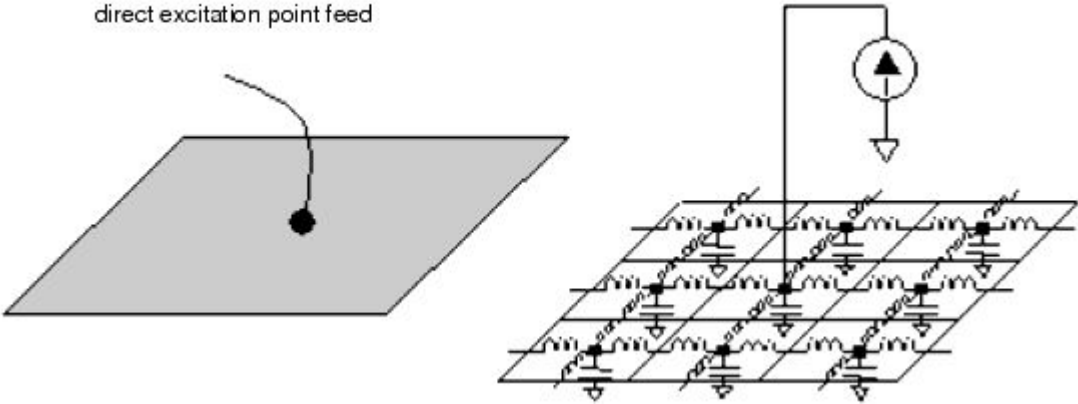

INFINITE GROUND PLANE

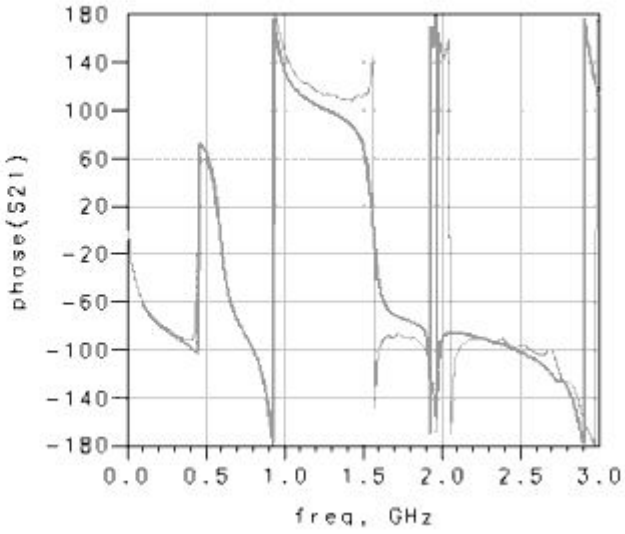
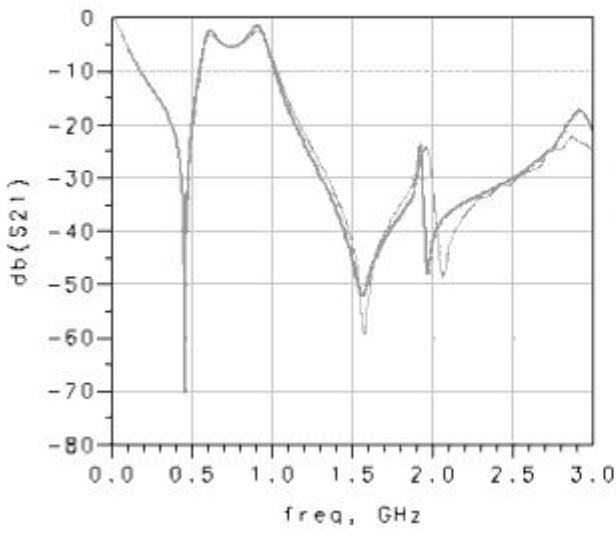
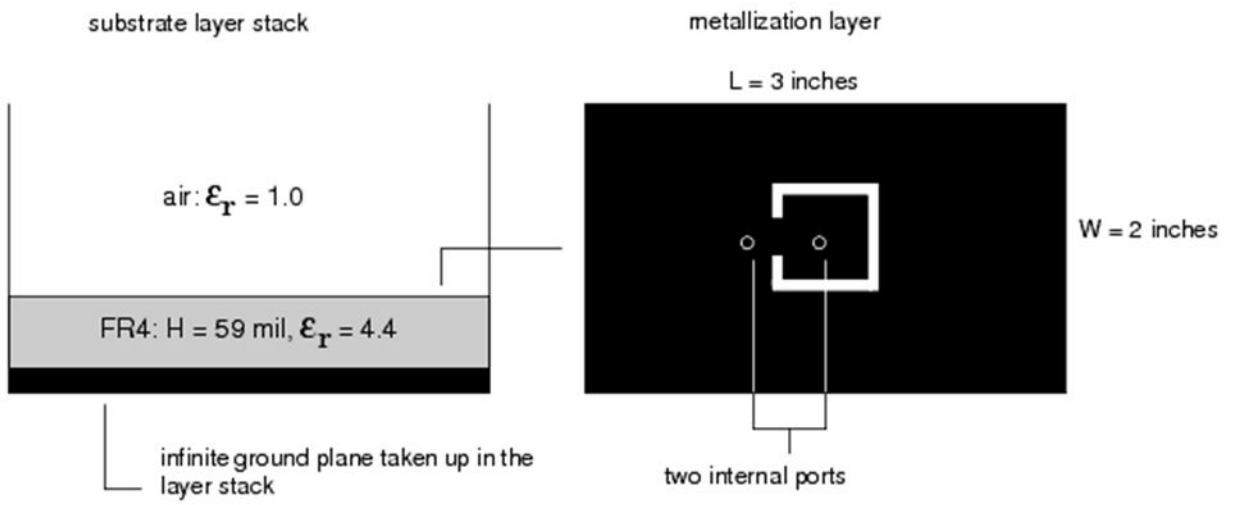

FINITE GROUND PLANE/NO GROUND PORTS

substrate layer stack

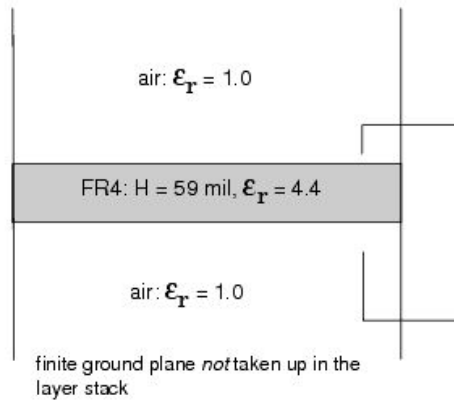

metallization layer

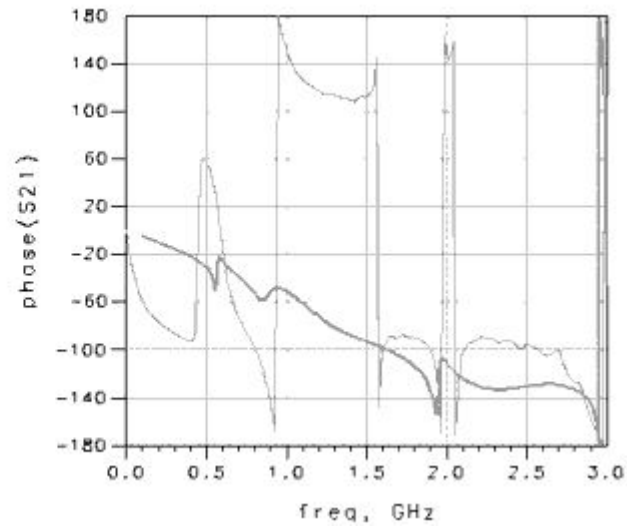
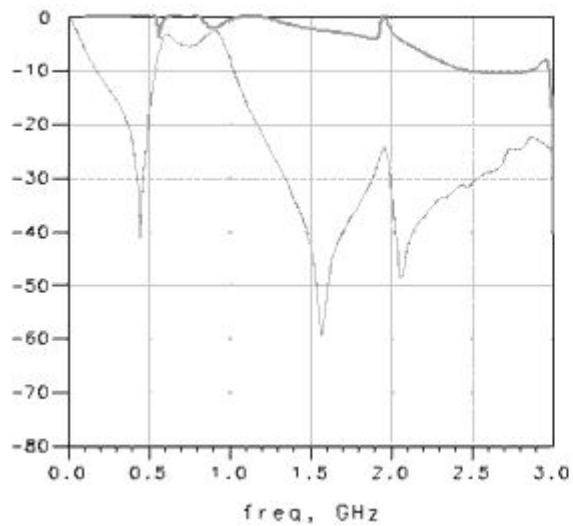
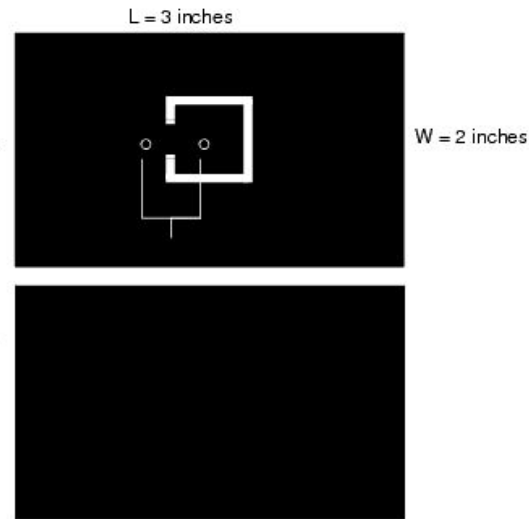

FINITE GROUND PLANE/PORTS IN THE GROUND PLANE

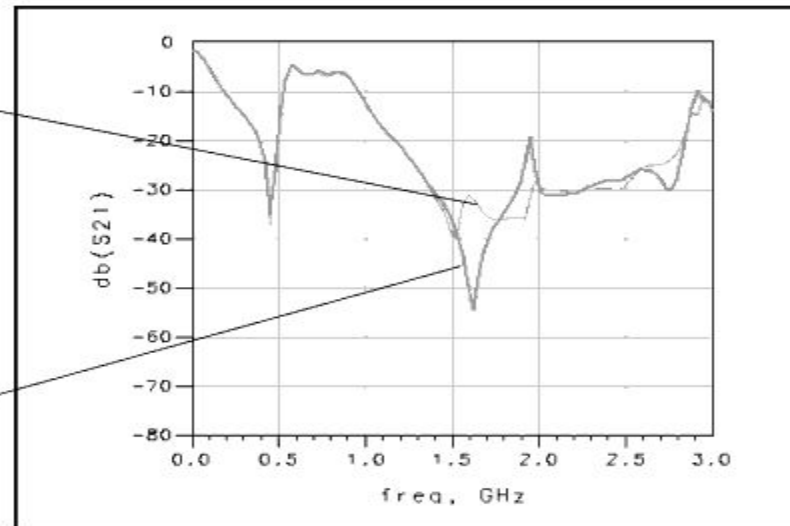
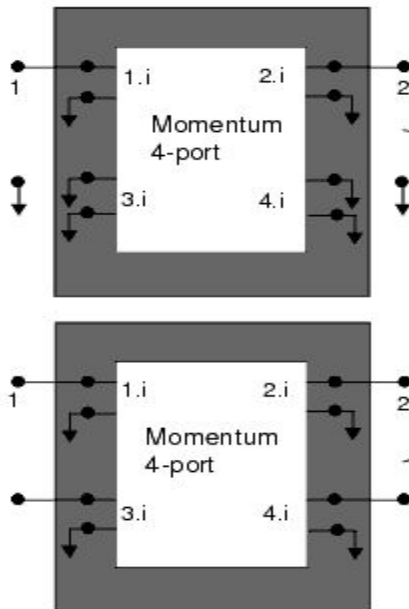
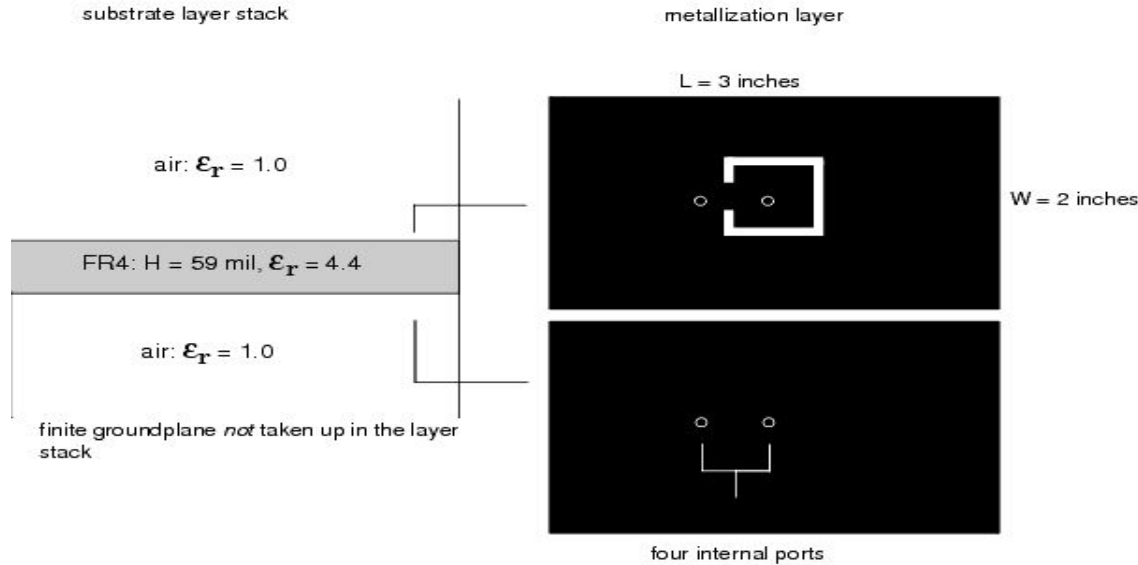

FINITE GROUND PLANE/GROUND REFERENCE

substrate layer stack

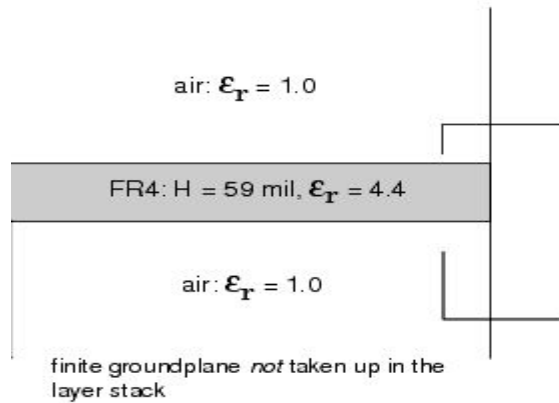

metallization layer

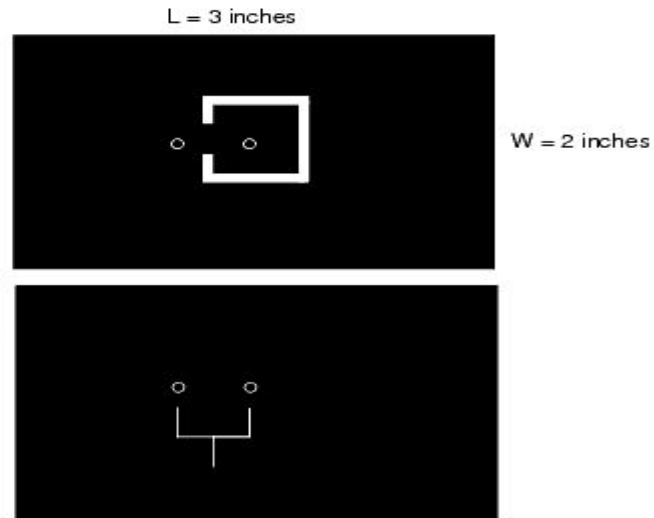

Two internal ports with associated ground reference ports

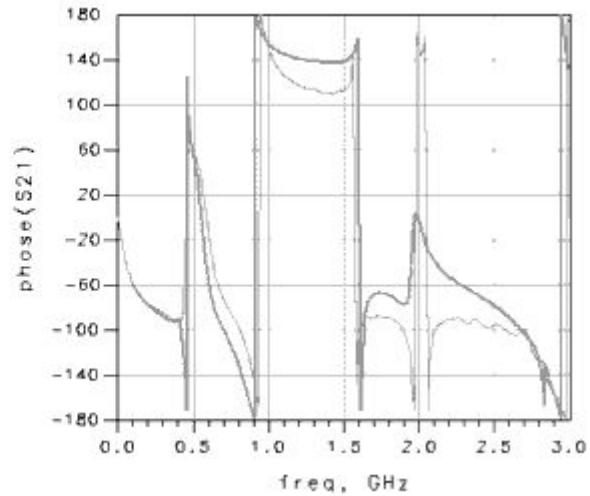
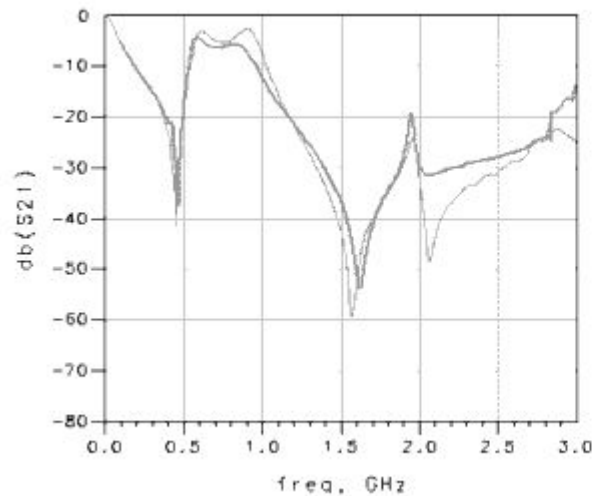

INTERNAL PORTS WITH CPW STRUCTURE

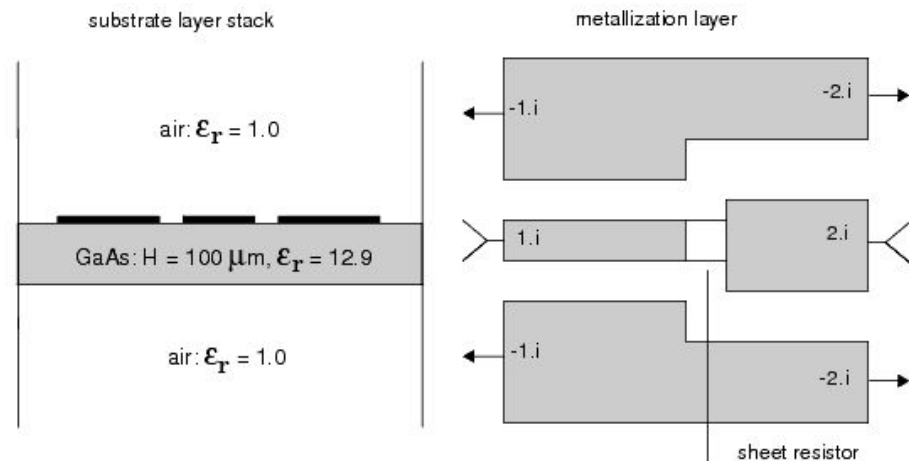
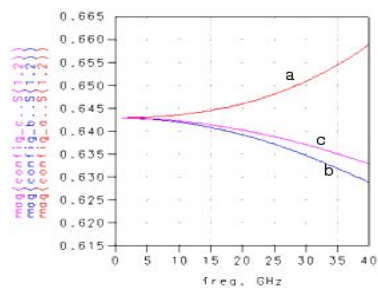
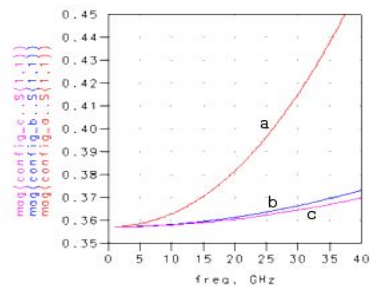
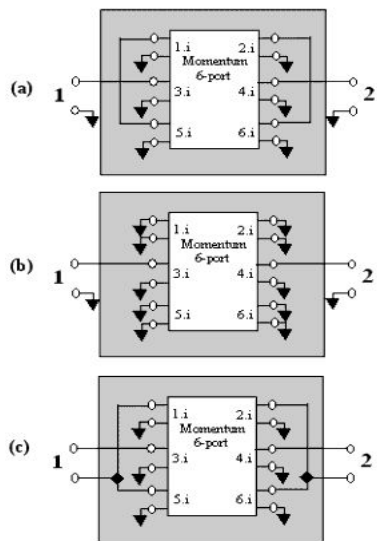
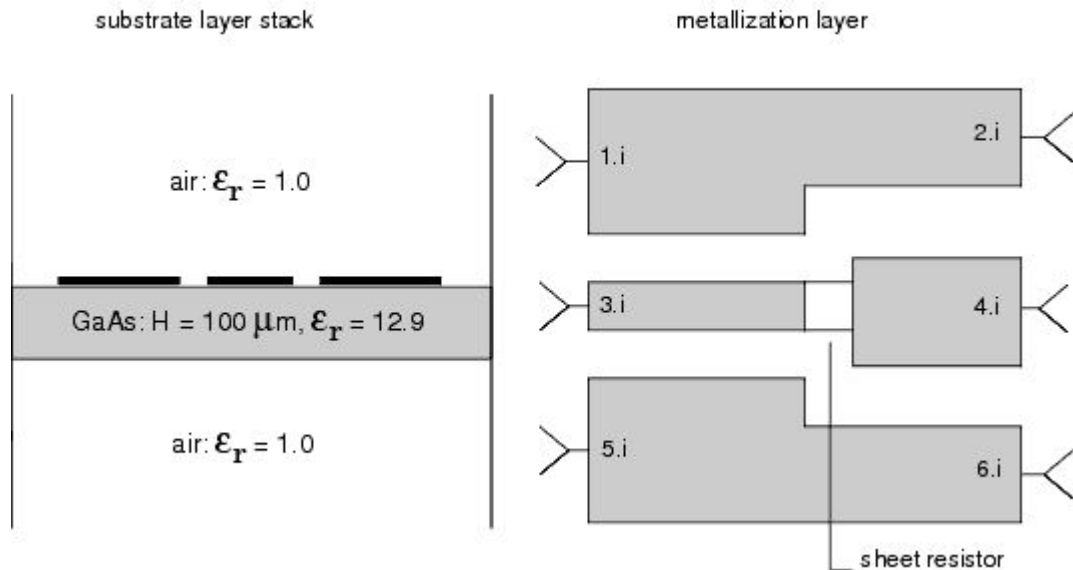

ЭЛЕКТРИЧЕСКИ МАЛЫЕ СХЕМЫ

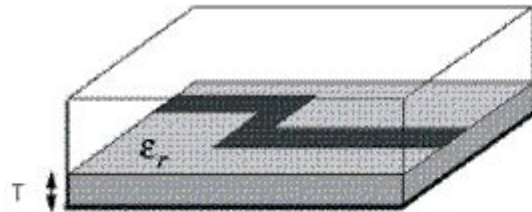

$\alpha = 20$ (with groundplane)

$\alpha = 10$ (without groundplane)

$$\text{Thickness} < \frac{\text{WaveLength}}{\alpha \sqrt{\epsilon_r - 1}}$$

$$\text{Freq [GHz]} < \frac{300}{\alpha \sqrt{\epsilon_r - 1} T [\text{mm}]}$$

$$F < \frac{150}{D}$$

$$D < \frac{150}{F}$$

КОНДУКТИВНЫЕ ПОТЕРИ

Sheet Conductor

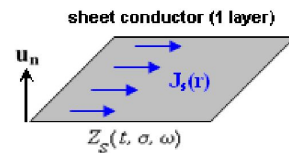

- model 0: DC resistance

$$Z_s(t, \sigma, \omega) = \frac{1}{\sigma t}$$

- model 1: single sided skin effect

$$Z_s(t, \sigma, \omega) = Z_c \coth(jk_c t)$$

- model 2 (default): double sided skin effect

$$Z_s(t, \sigma, \omega) = \frac{1}{2} Z_c \coth(jk_c \frac{t}{2})$$

With

$$Z_c = \sqrt{\frac{j\omega\mu}{\sigma + j\omega\varepsilon}}$$

$$jk_c = \sqrt{j\omega\mu(\sigma + j\omega\varepsilon)}$$

Thick Conductor (2D Distributed Model)

No horizontal currents on the conductor sides are allowed. Deprecated setting.

- model 0: 2-layer sheet conductor
 - each layer has half the conductor thickness
 - each layer is modeled with DC resistance sheet model

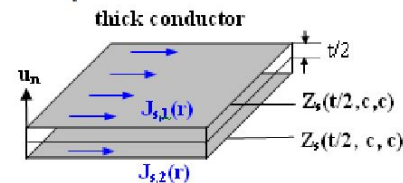

- model 1: 2-layer sheet conductor *Note: this is default in ADS 2003C*

- each layer has half the conductor thickness
- each layer is modeled with single-sided skin effect sheet model

- model 2 (default): 2-layer sheet conductor

- 2 surface current layers at top and bottom
- both modeled with coupled skin effect

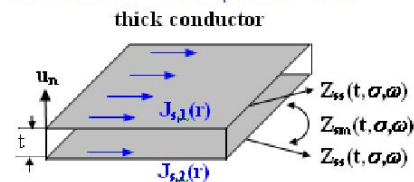

$$Z_{s,s}(t, \sigma, \omega) = \frac{1}{2} (Z_1 + Z_2)$$

$$Z_{s,m}(t, \sigma, \omega) = \frac{1}{2} (Z_1 - Z_2)$$

$$Z_1 = \frac{Z_{c,1} Z_{c,2}}{Z_{c,1} \tanh(jk_{c,2} \frac{t}{2}) - Z_{c,2} \tanh(jk_{c,1} \frac{t}{2})}$$

$$Z_2 = \frac{Z_{c,1} Z_{c,2}}{Z_{c,1} \coth(jk_{c,2} \frac{t}{2}) - Z_{c,2} \coth(jk_{c,1} \frac{t}{2})}$$

medium 1 = background layer, medium 2 = conductor

Thick Conductor (3D Distributed Model)

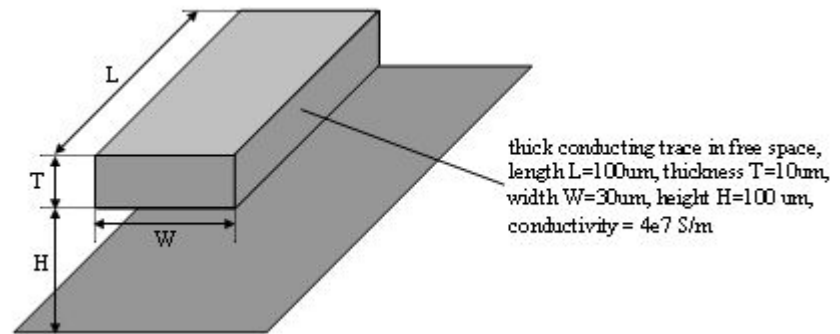
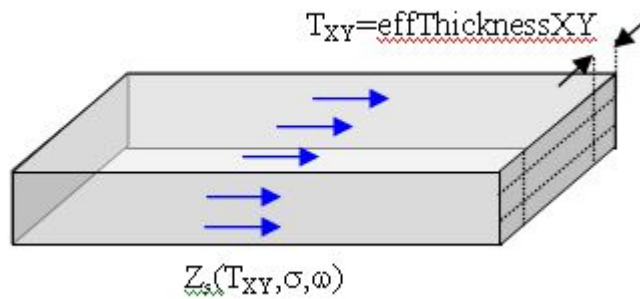

Example: Single Trace in Free Space

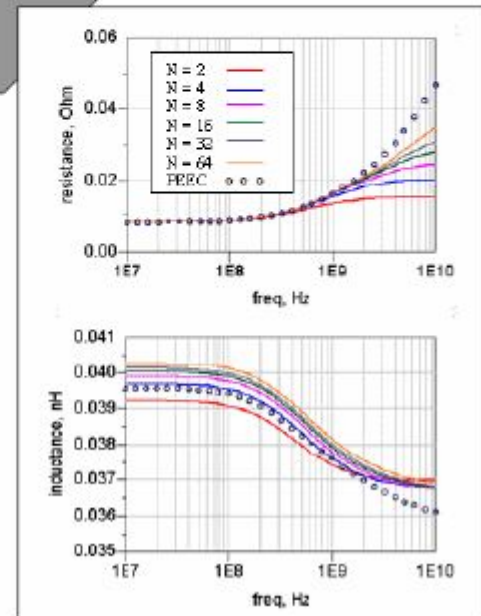
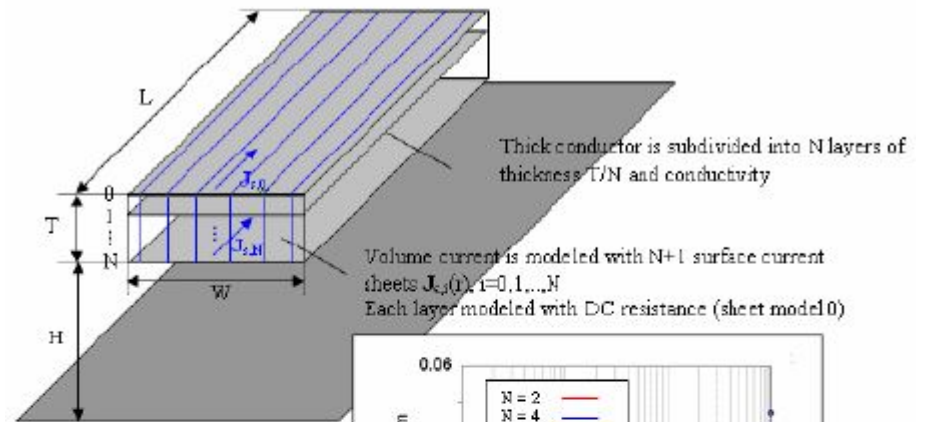
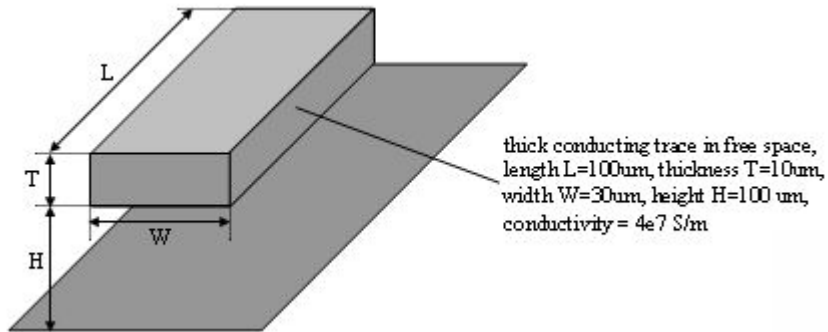

Results Using Sheet Conductor Models

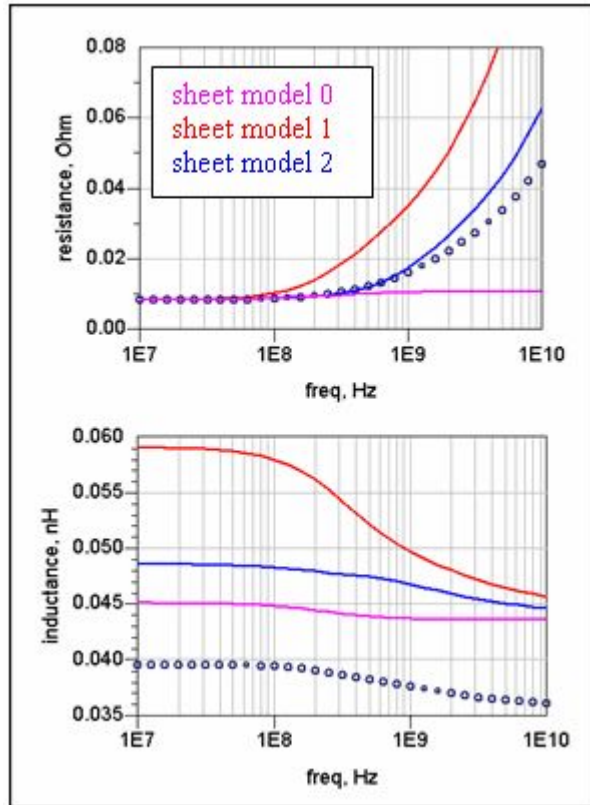

Results Using Thick Conductor Models

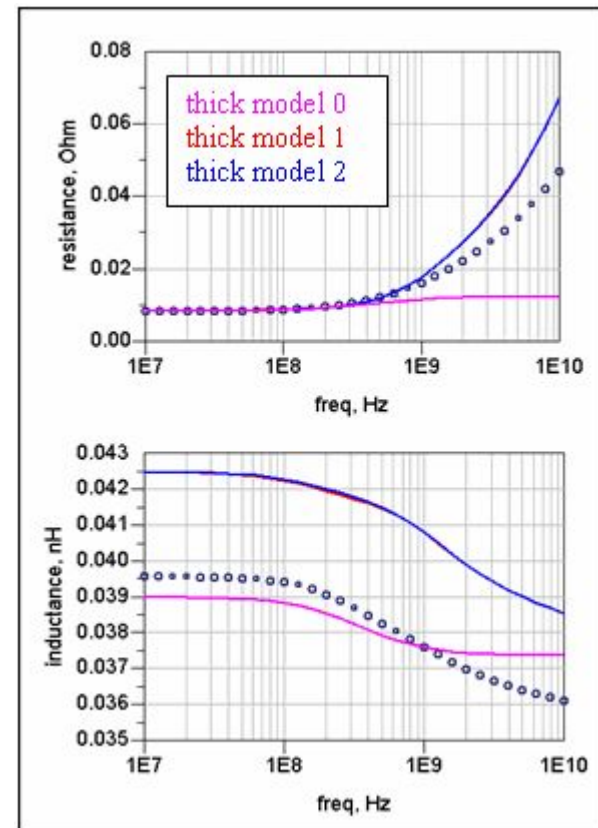

Example: Folded Trace in Free Space

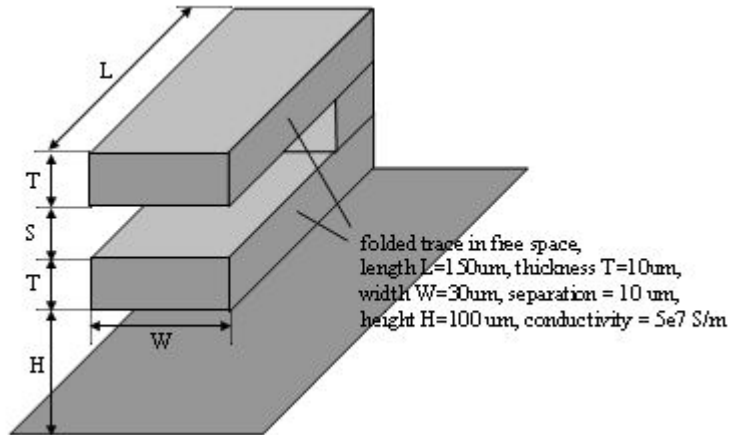

Results Using Thick Conductor Models

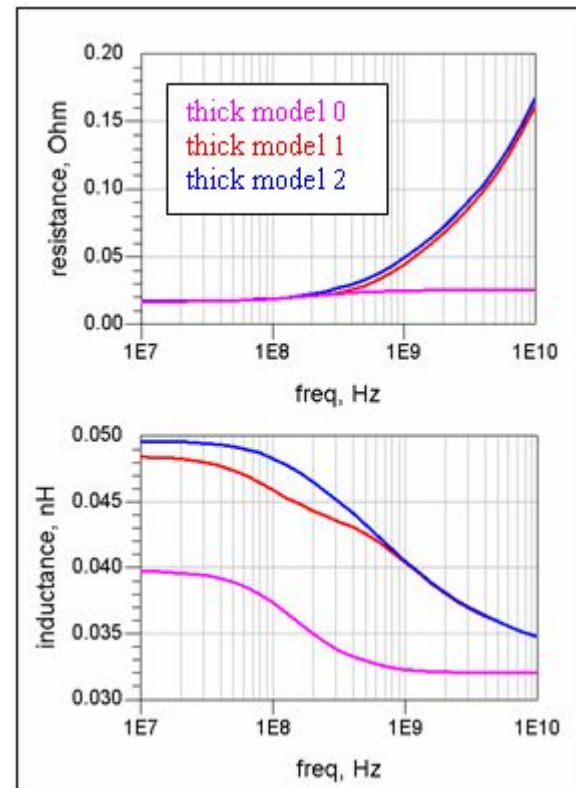

РЕЖИМ МОДЕЛИРОВАНИЯ

