

# Тест 3

- На всех карточках этого теста, кроме двух последних, изображены два различных положения многогранника: куба, тетраэдра или октаэдра. На первом рисунке дано его исходное положение, на втором – после некоторого перемещения в пространстве. Требуется нанести на второе изображение новое положение фигур, выделенных на первом рисунке.

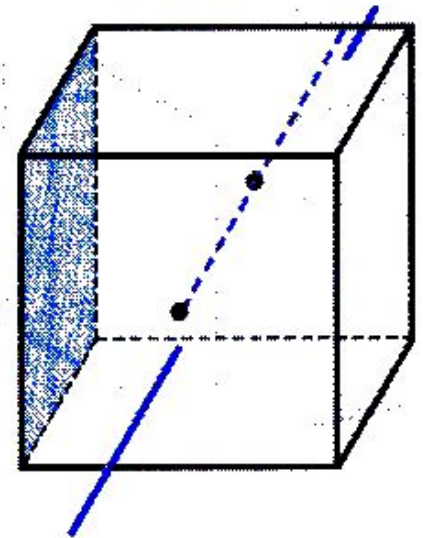

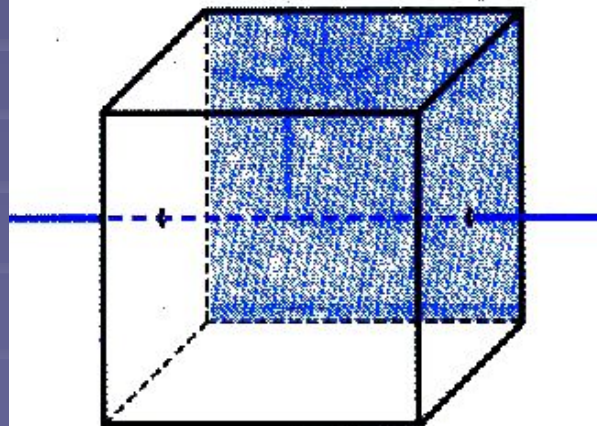

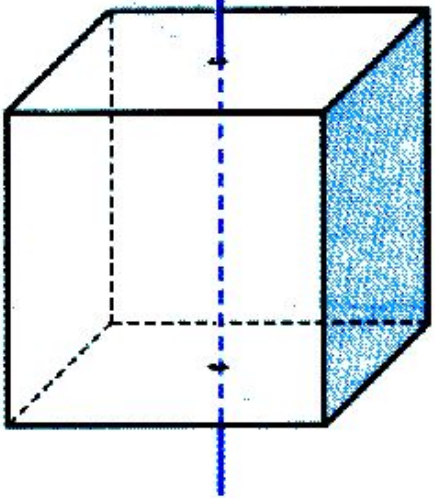
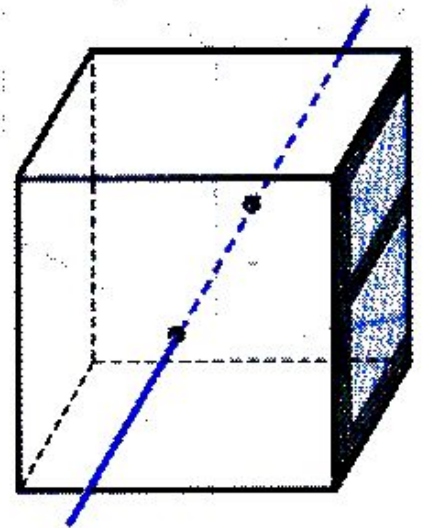
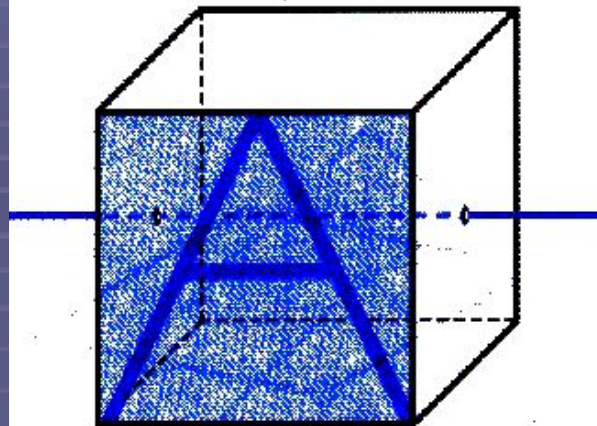
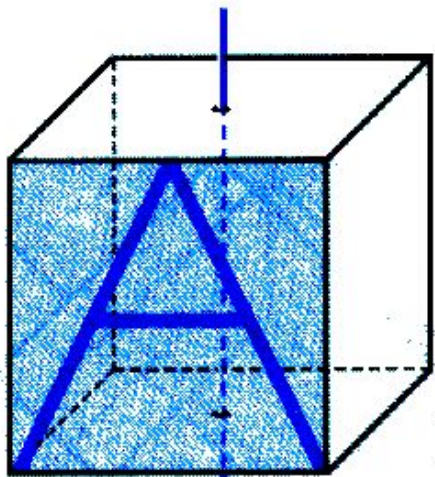
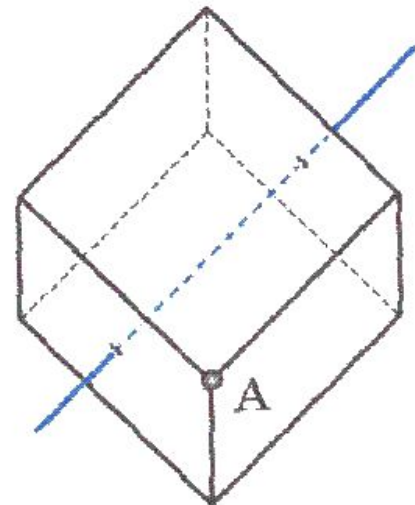
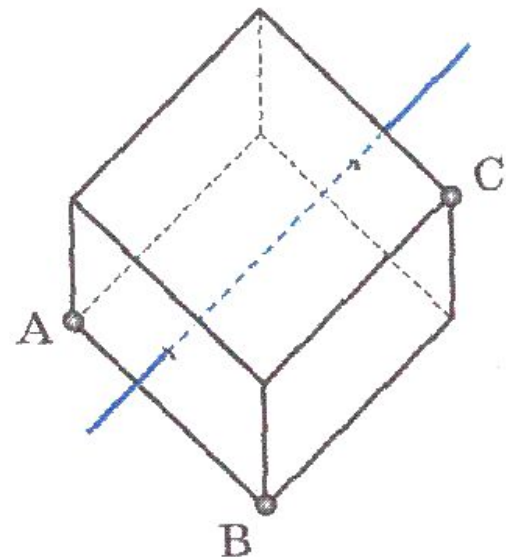
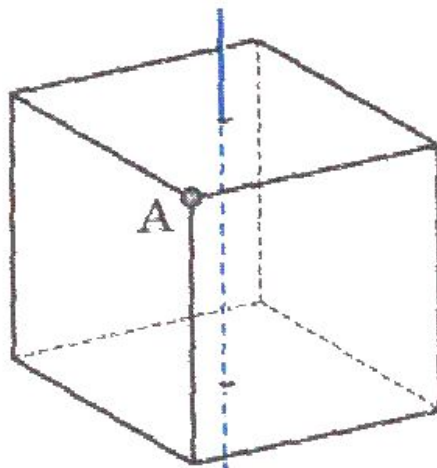
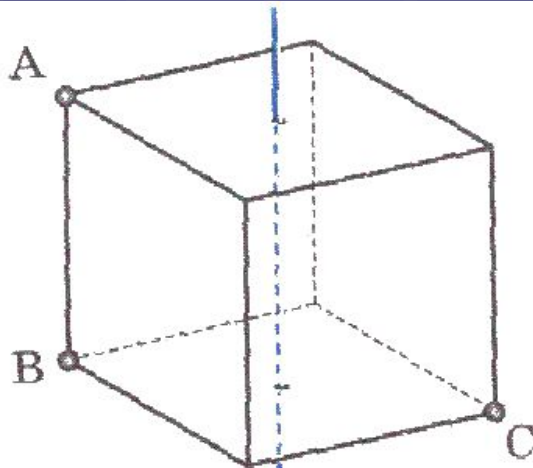
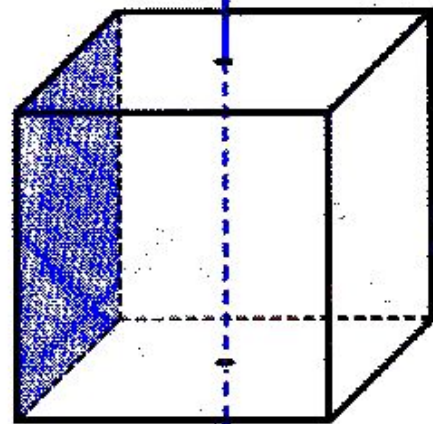
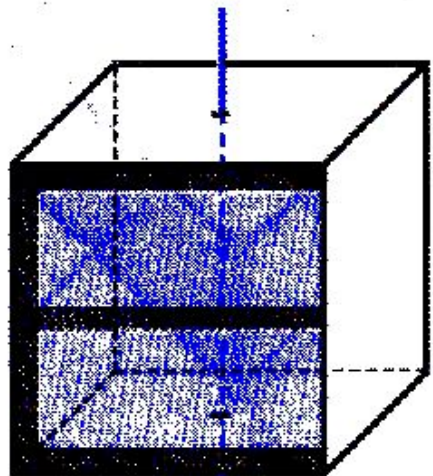
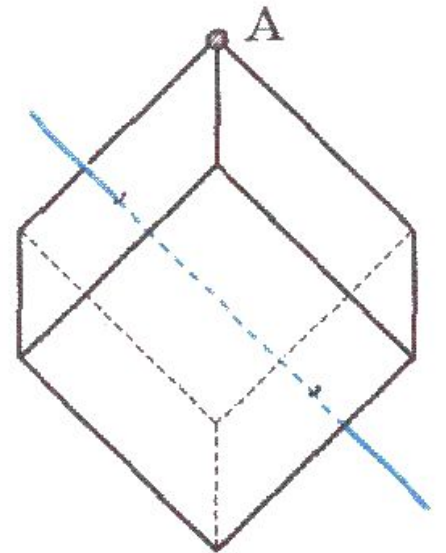
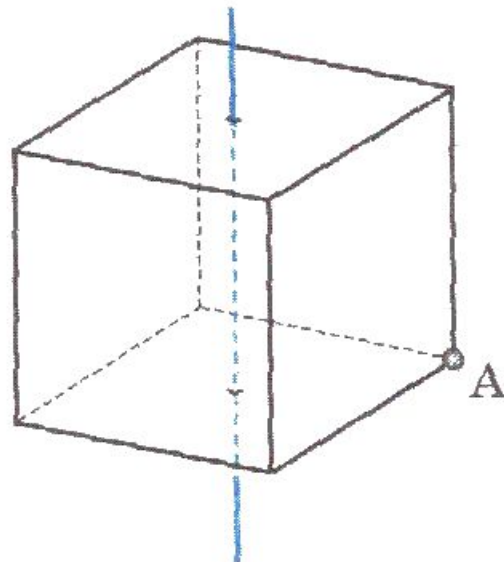
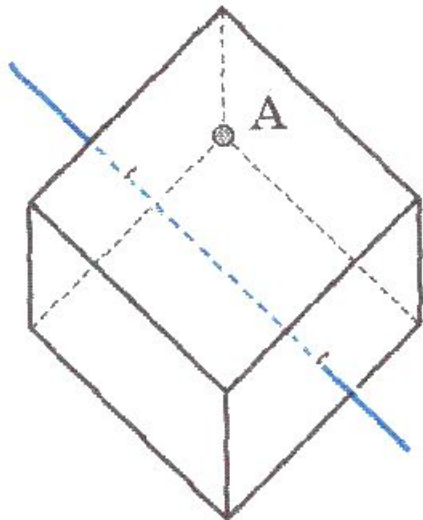
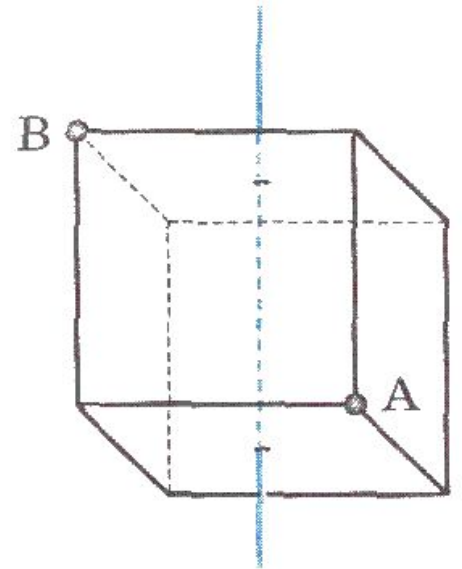
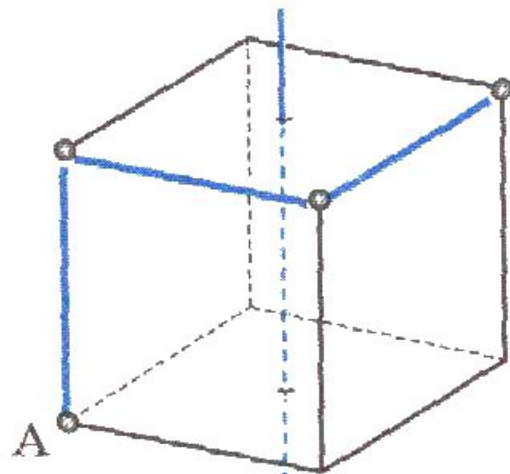
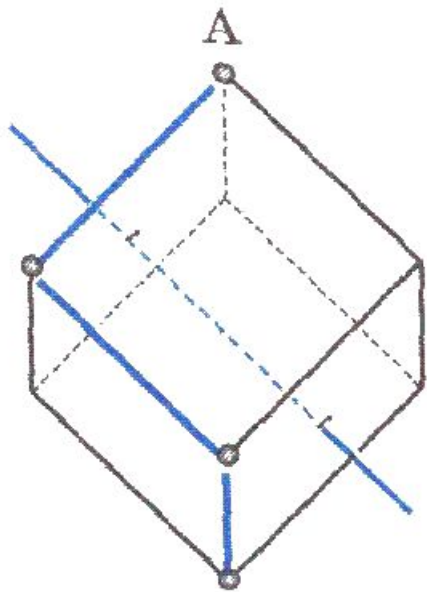



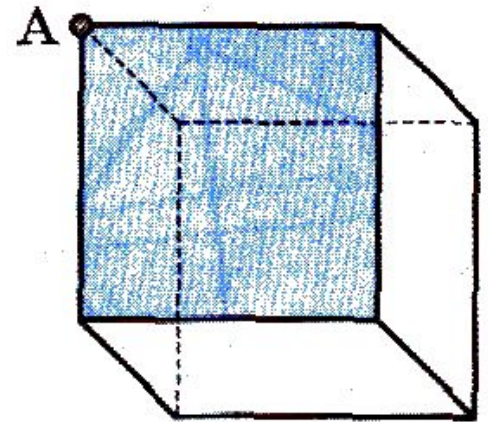
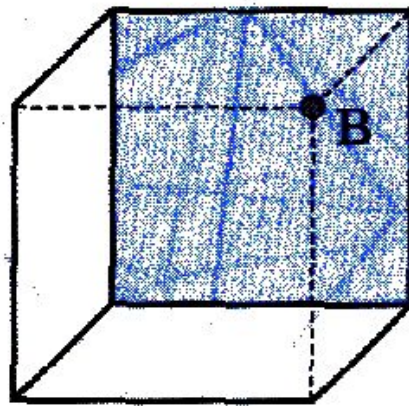
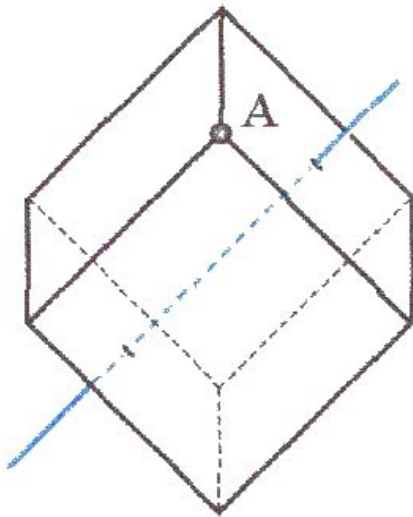
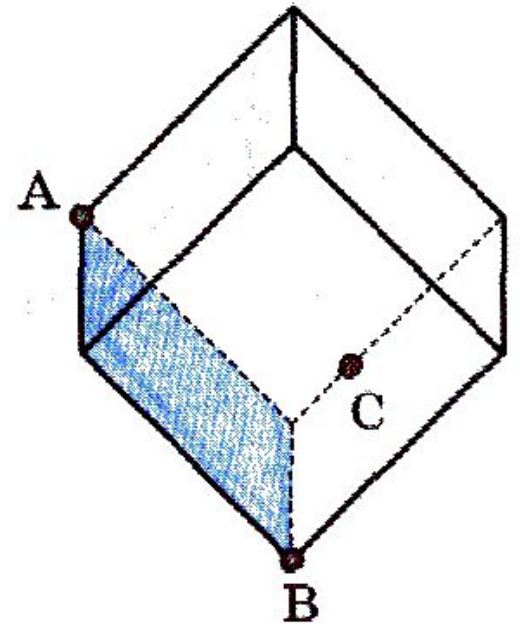
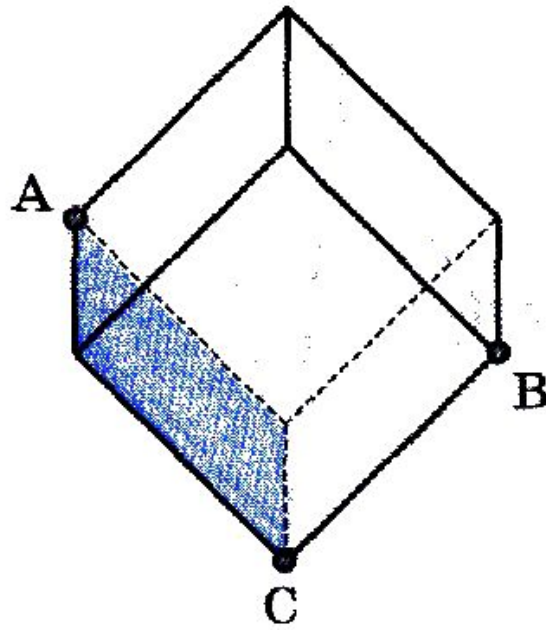
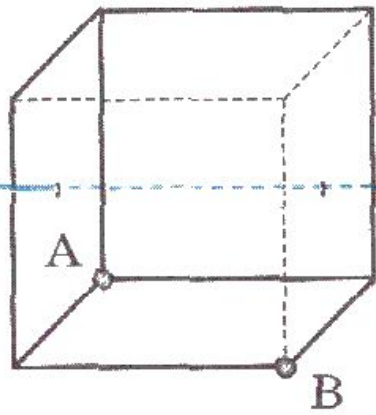

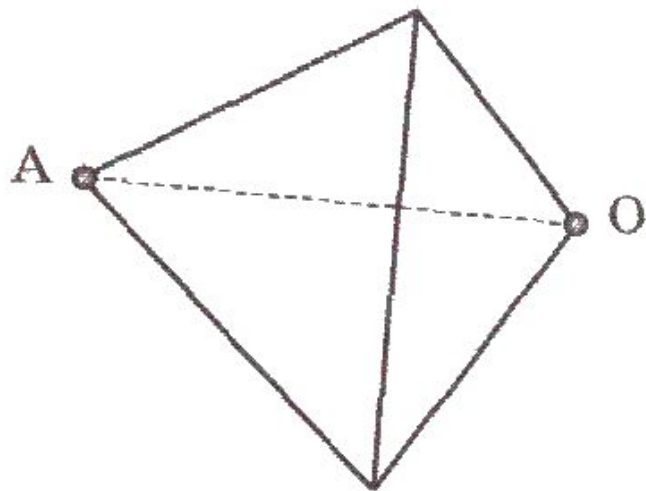
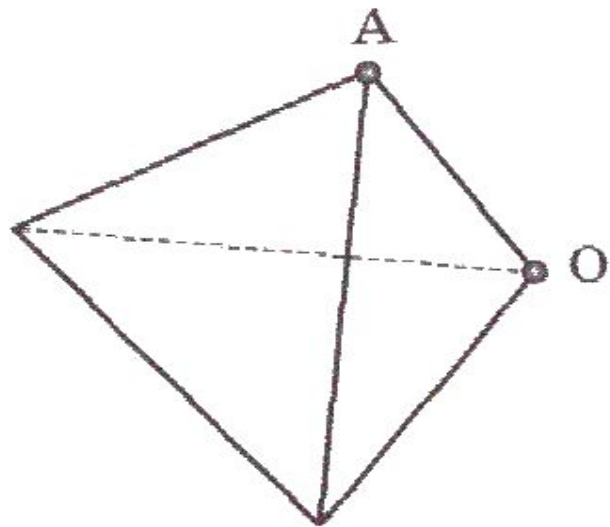
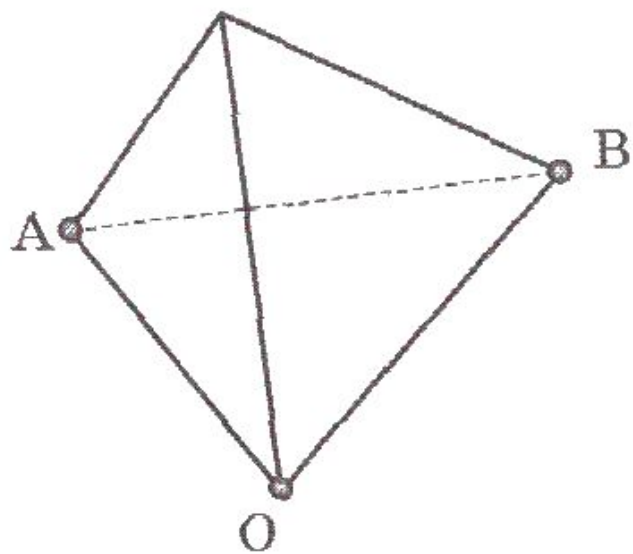
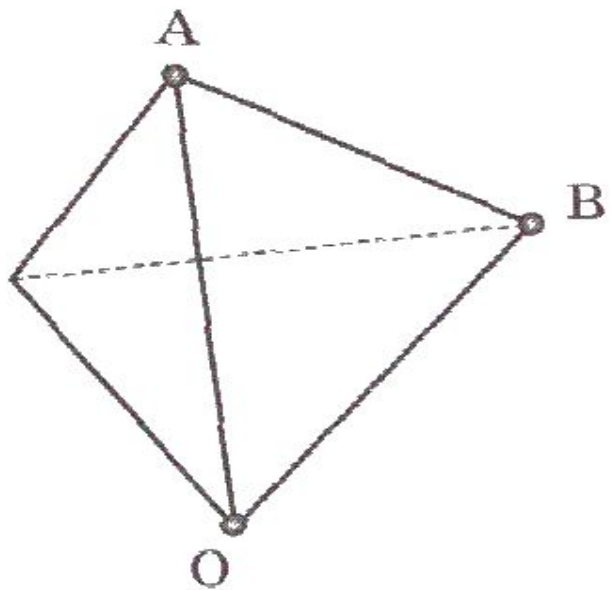

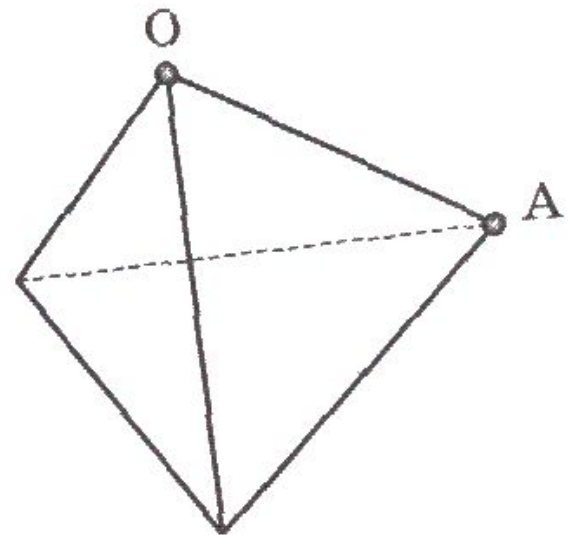
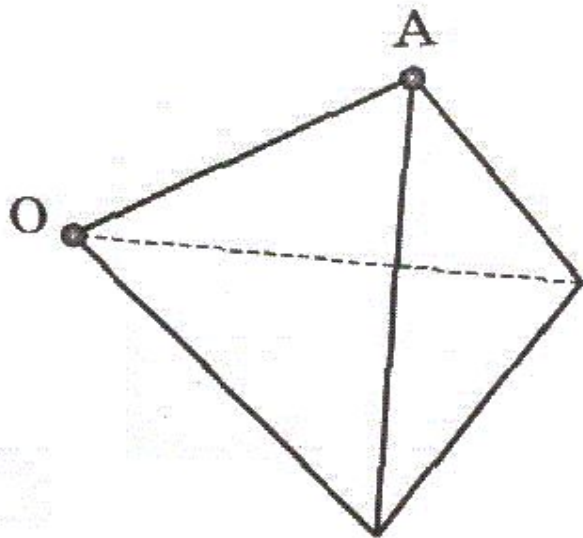
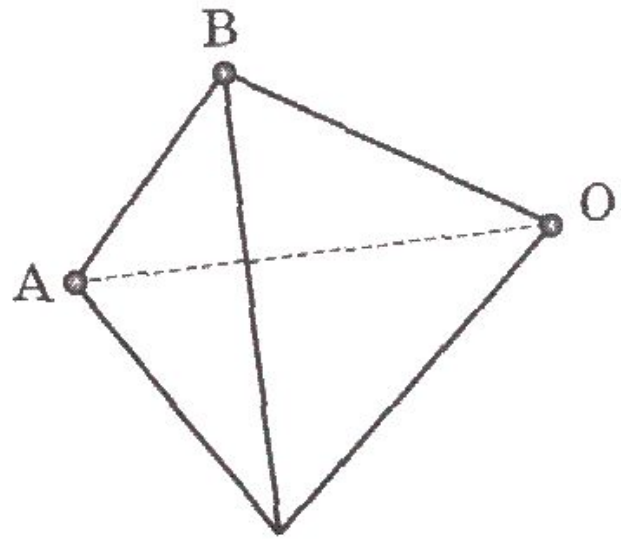
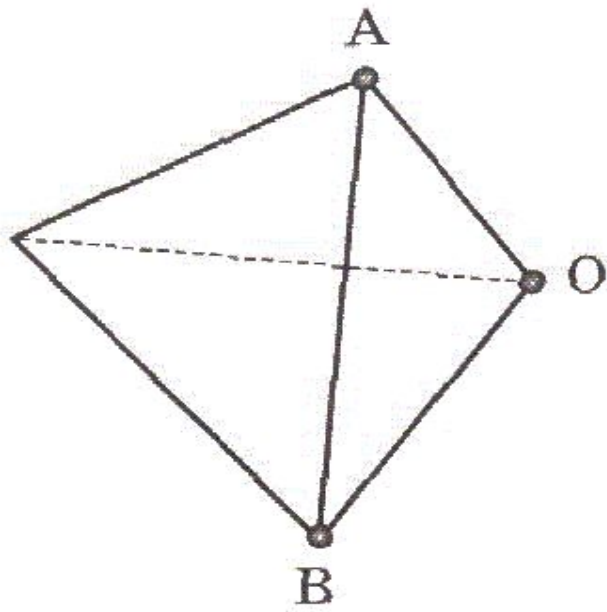

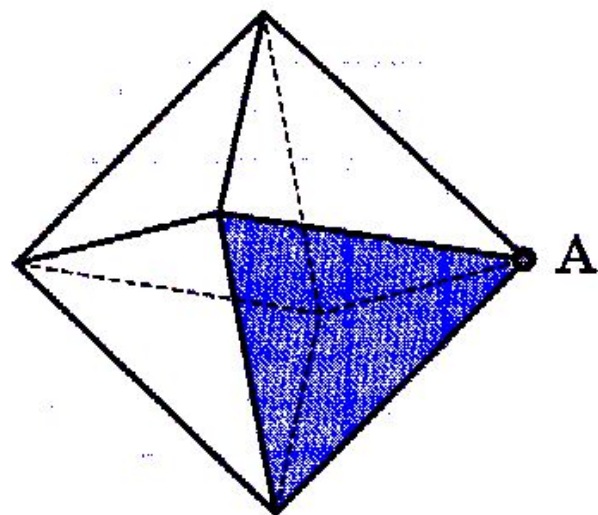
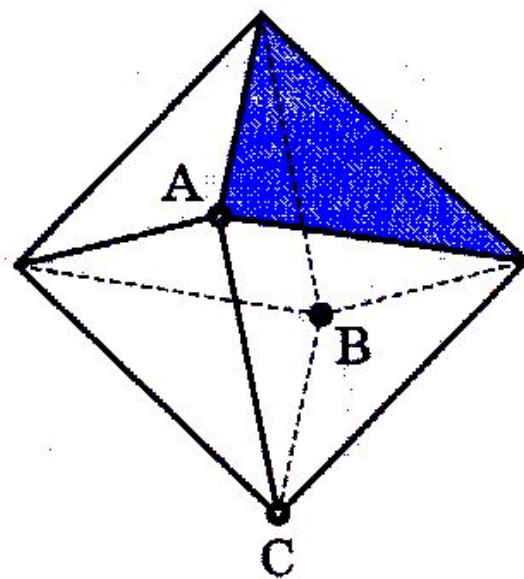
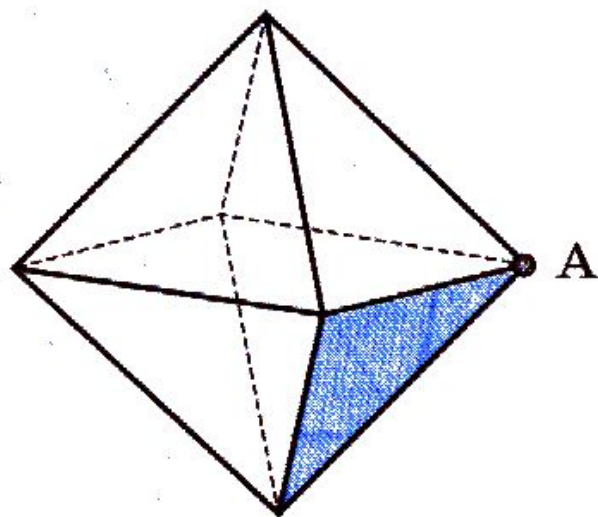
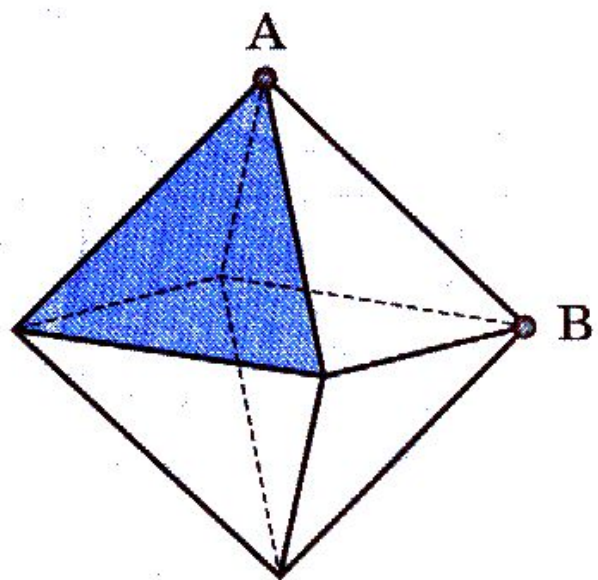



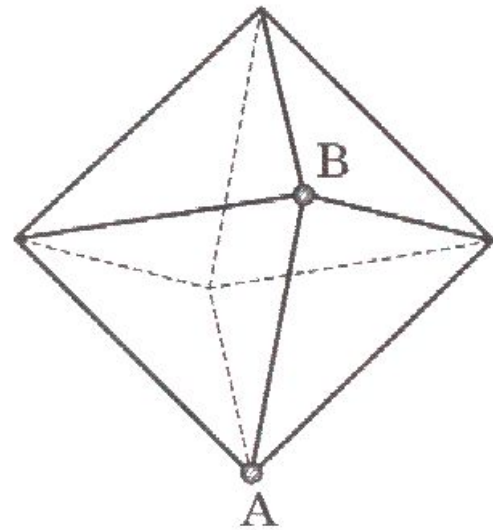
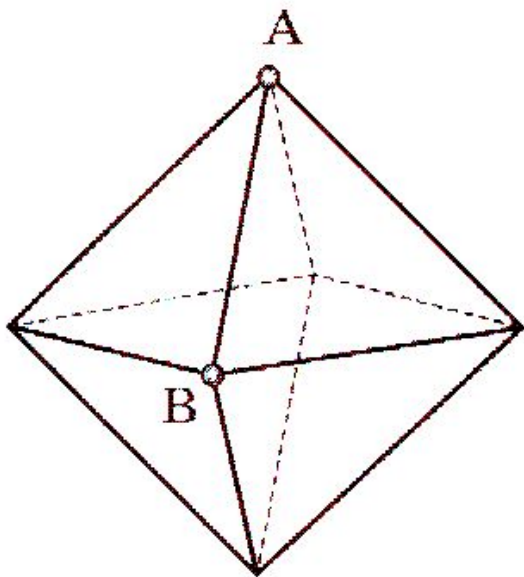
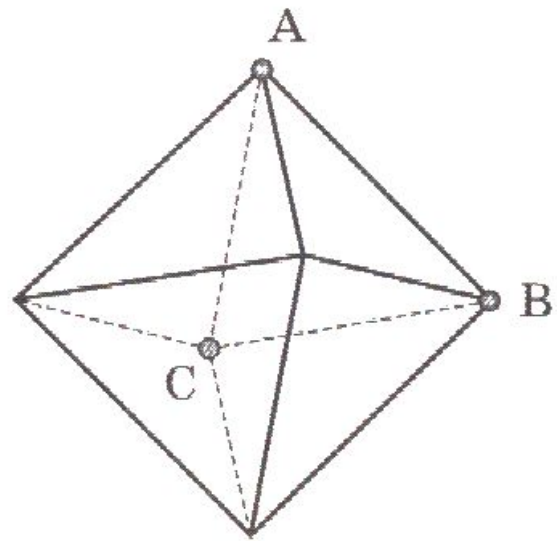
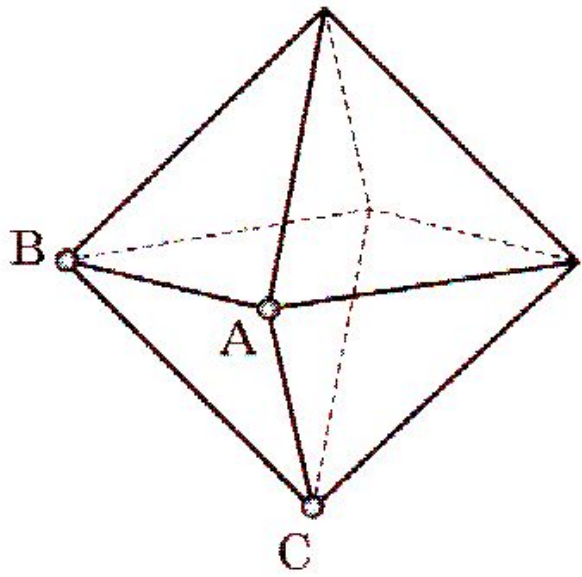

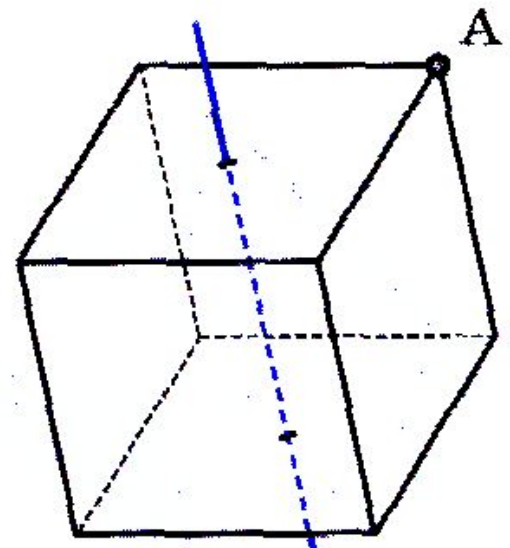
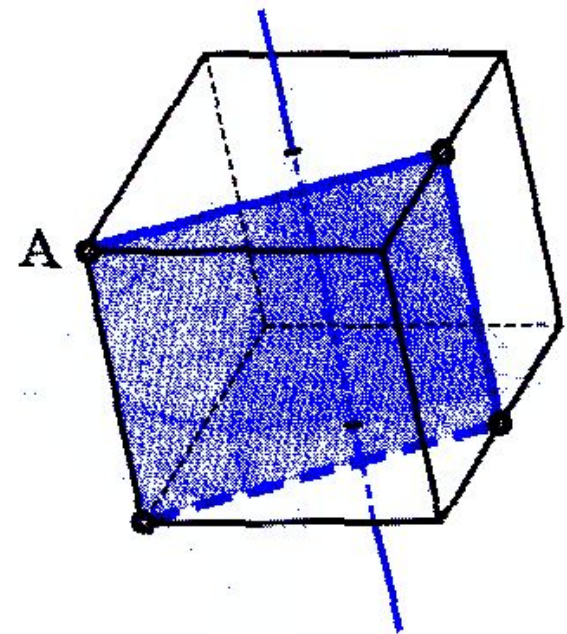
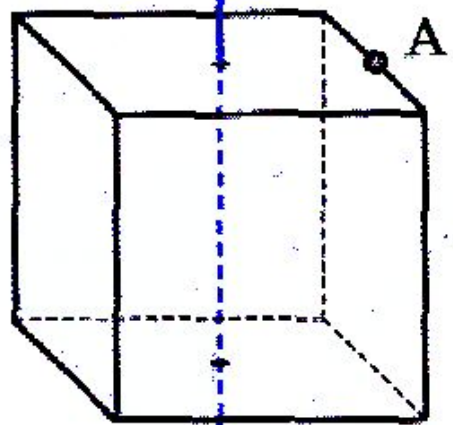
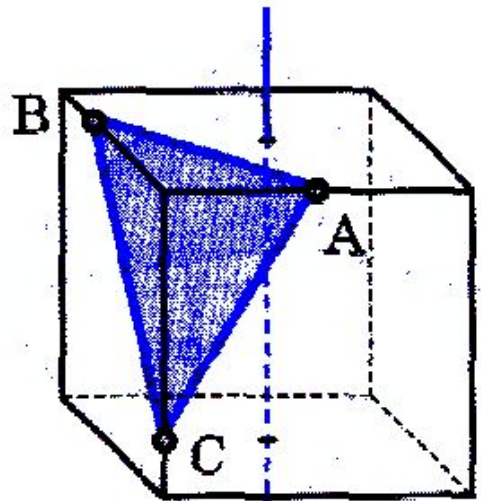

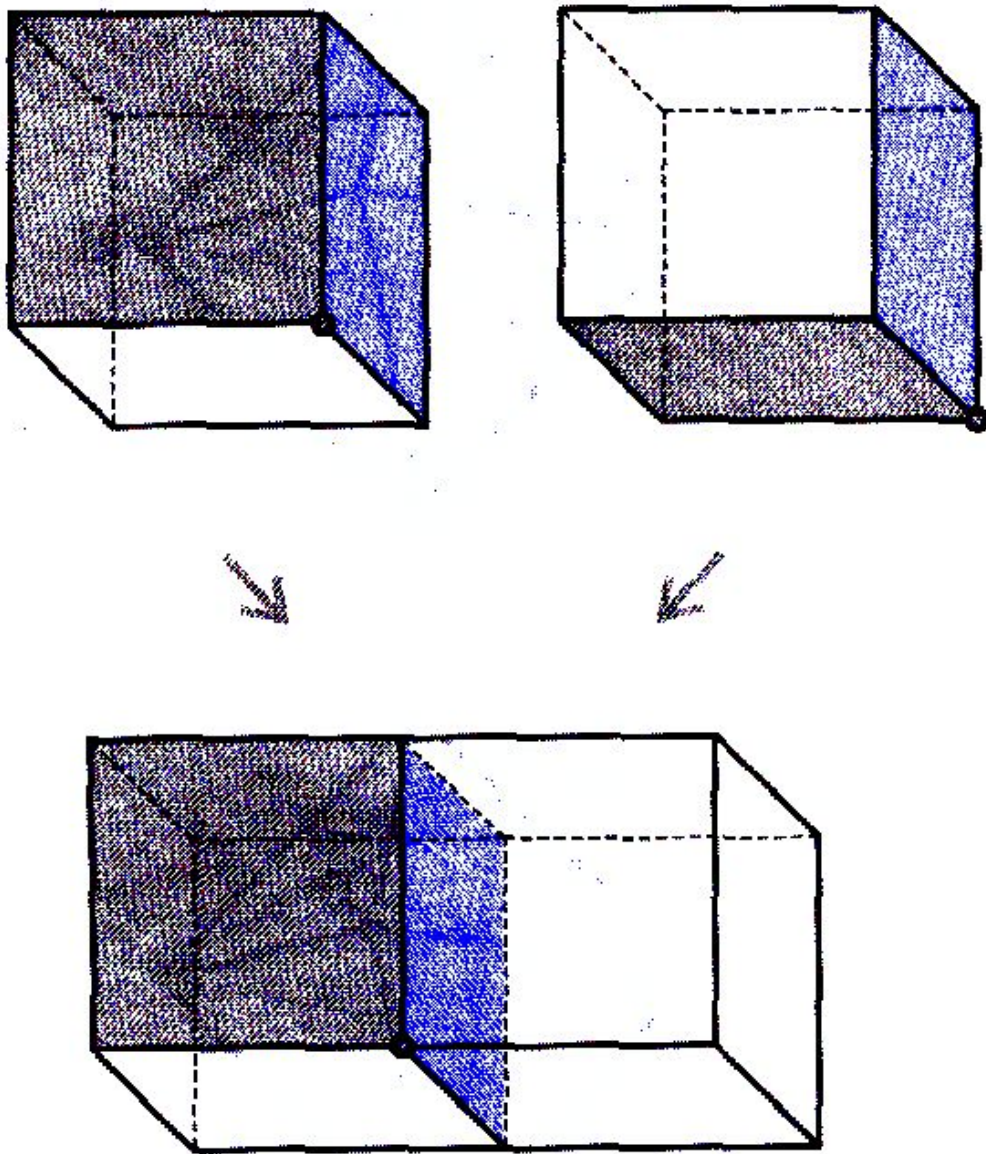

- Покажите на правом кубике серую грань

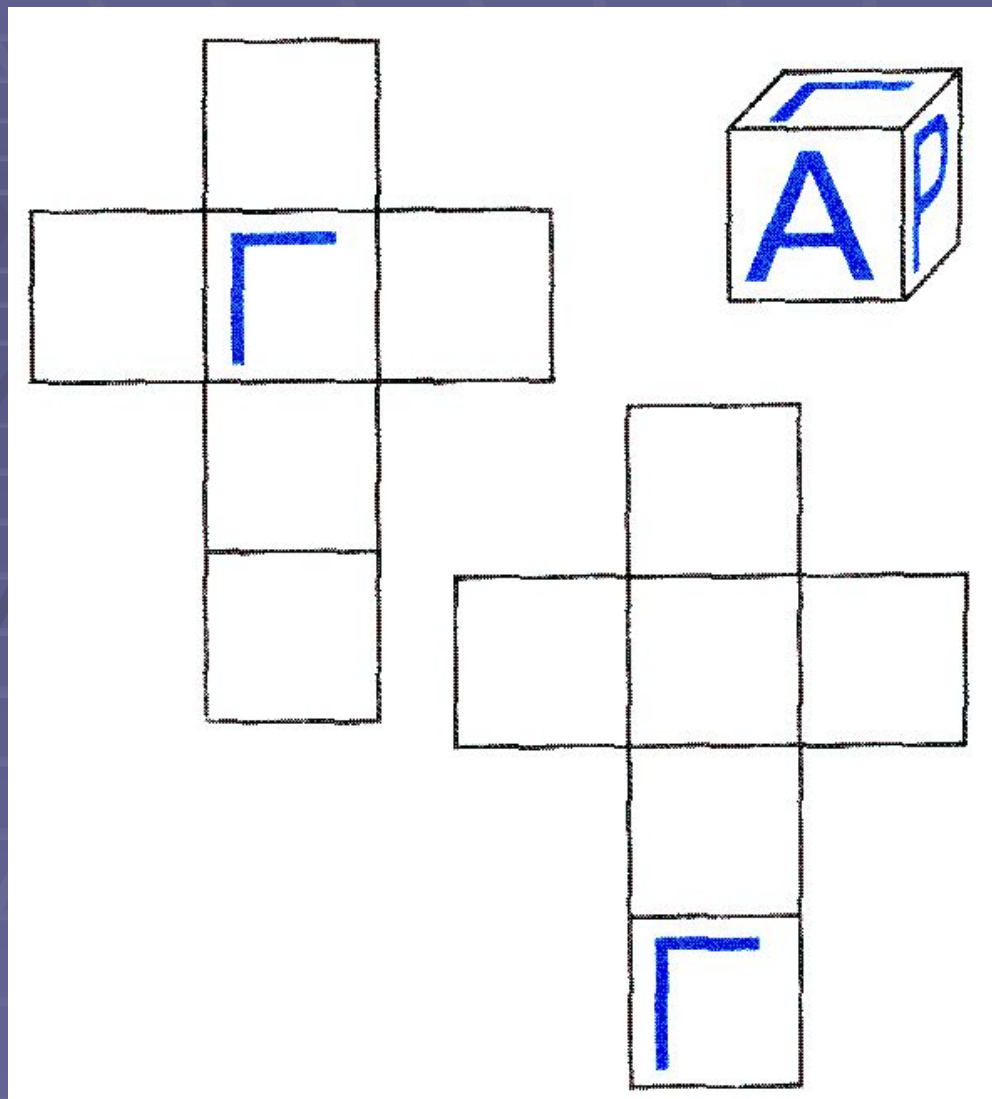

- Нанесите на развертки буквы А и Р, правильно расположив их