

U _{ВЫХ} , В	АЦП	%	Δ
2,500	512	75,00	0,833
3,333	682	88,89	0,417
3,750	767	93,75	0,250
4,000	818	96,00	0,167
4,167	853	97,22	0,119
4,286	877	97,96	0,089
4,375	895	98,44	0,069
4,444	909	98,77	0,056
4,500	921	99,00	0,045
4,545	930	99,17	0,038

$$5\text{В}/1023=0,0049$$

В

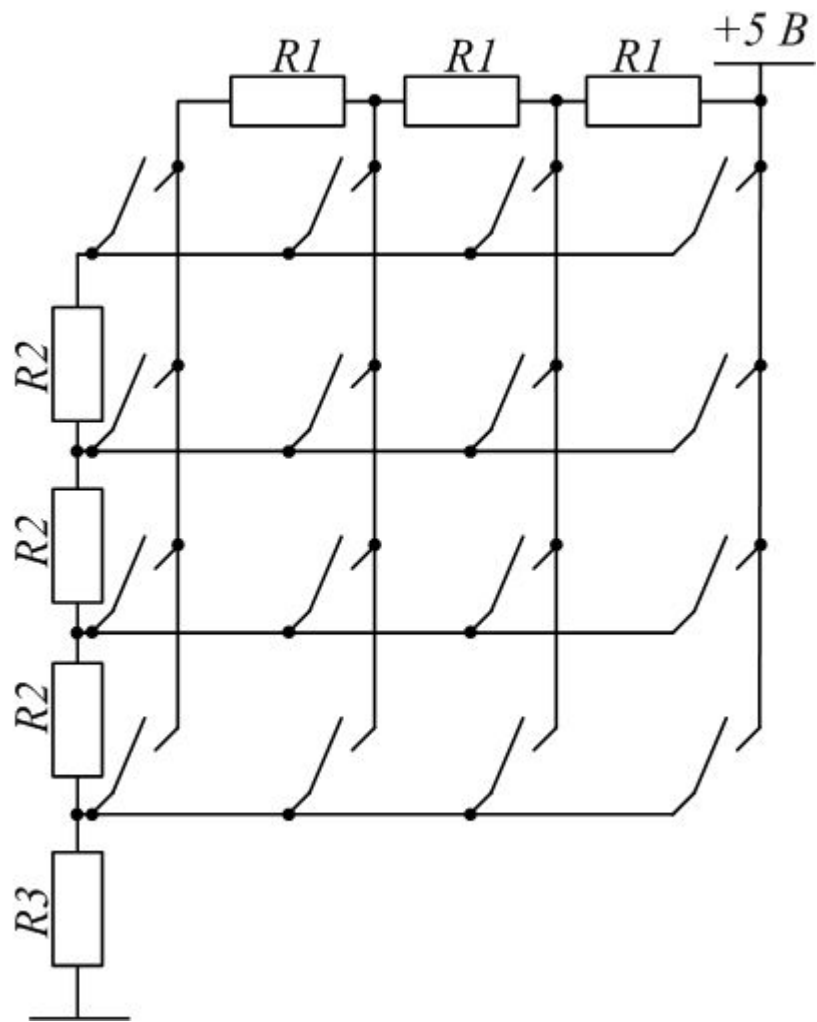

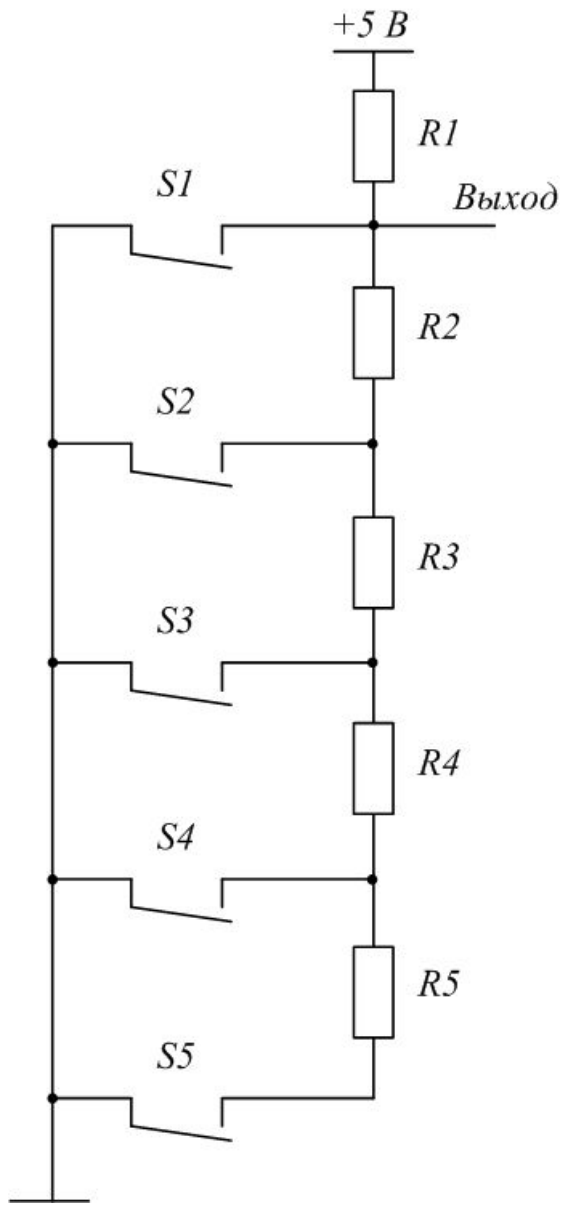
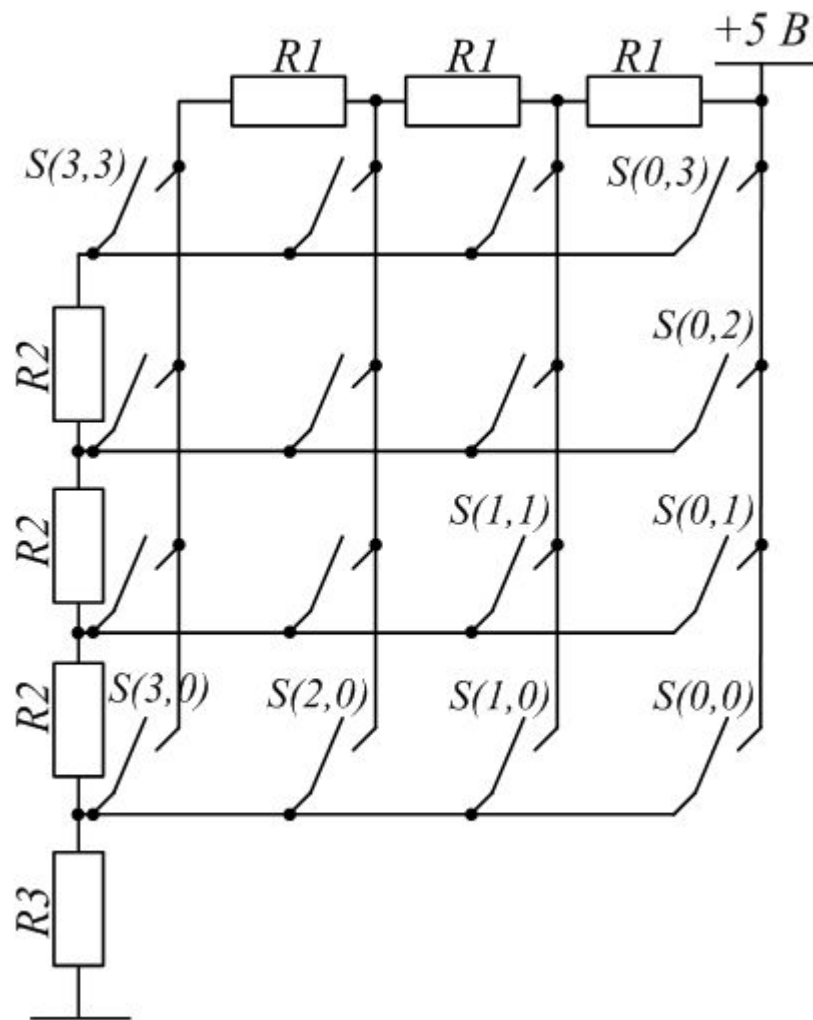
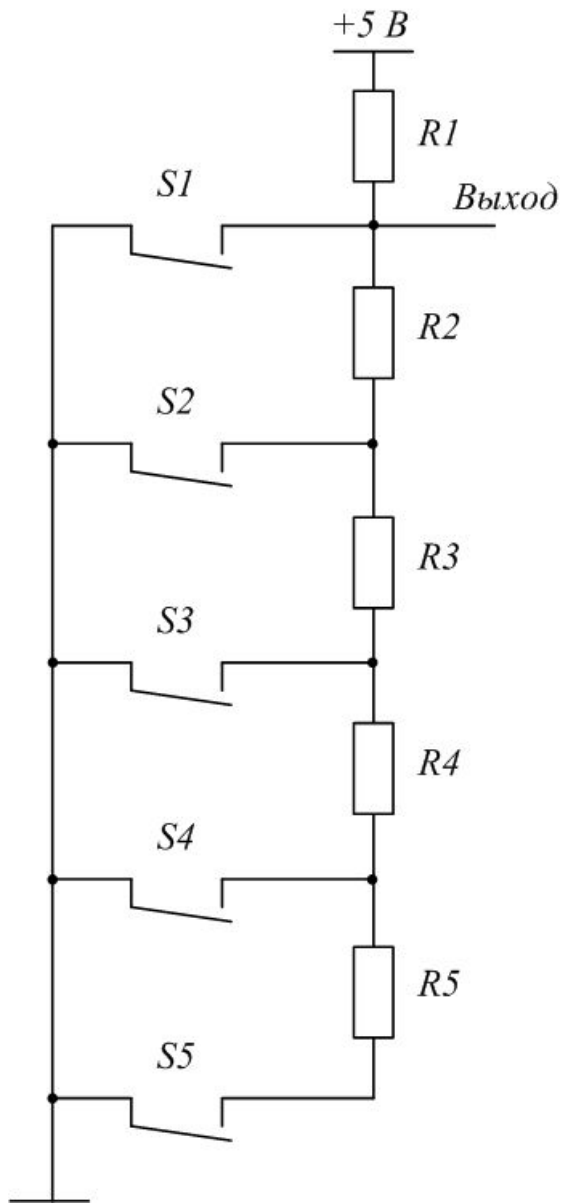

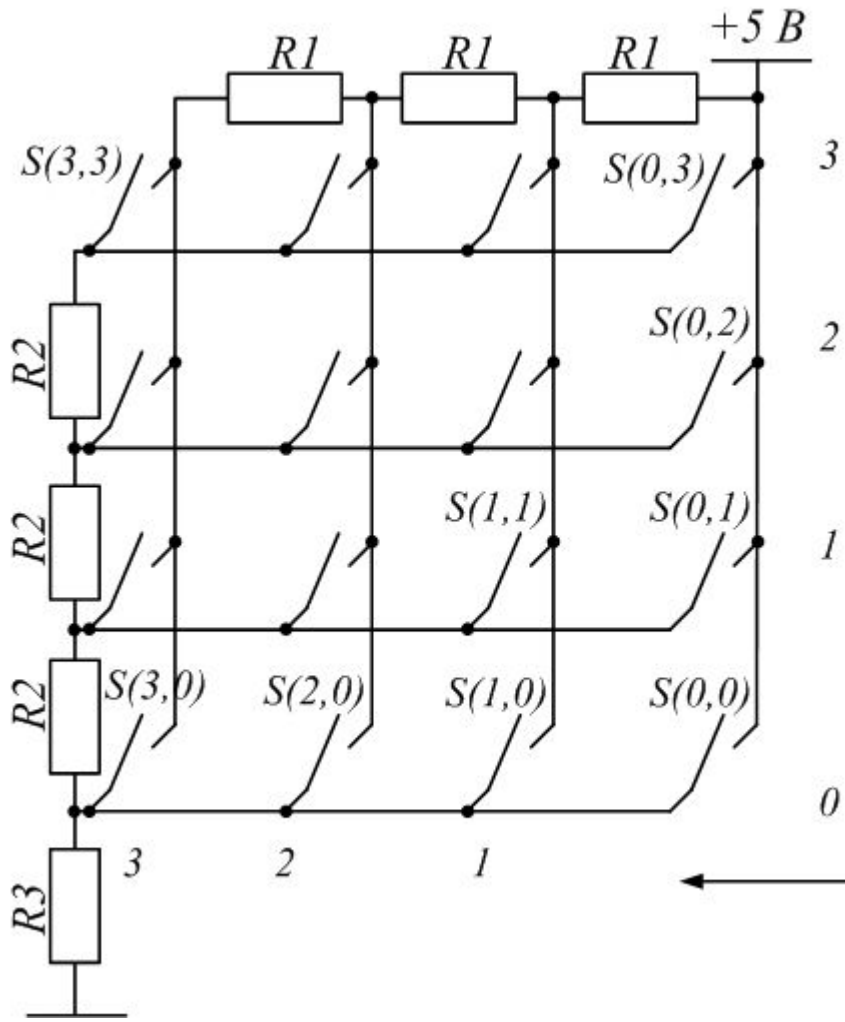

$$U_{out} = \frac{V(5B) \cdot R3}{R1x + R2y + R3}$$

Датчик Холла ДХК-0,5

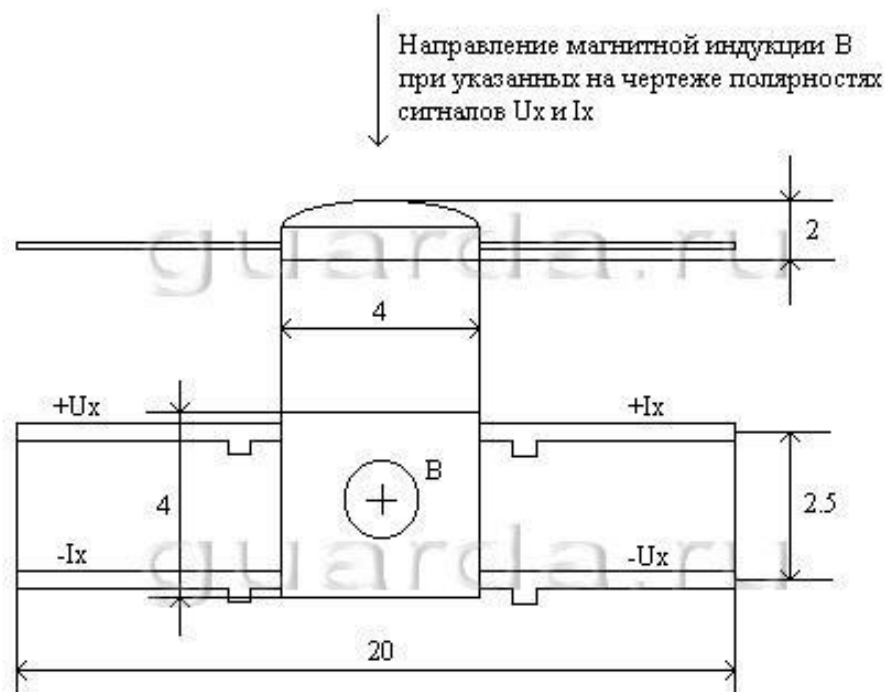

ДХК-0.5А



Датчик Холла ДХК-0,5

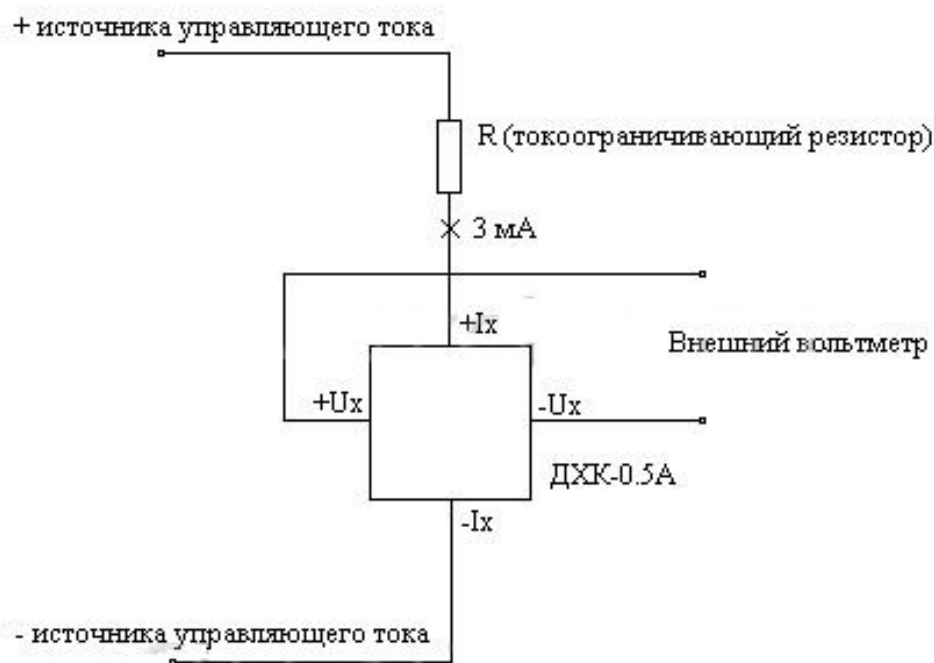

Напряжение источника управляющего тока около 9 В.
Сопротивление токоограничивающего резистора около 1 кОм
(подбирается для установки величины управляющего тока 3 мА).

Подключение ДХК-0,5 к АЦП МК

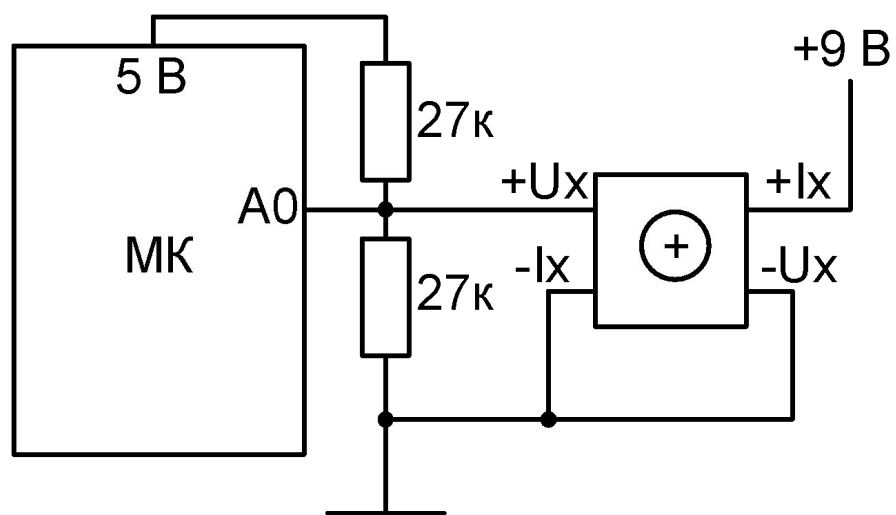

Индикатор магнитного поля, на основе аналогового датчика Холла ДХК-0,5 и МК Arduino

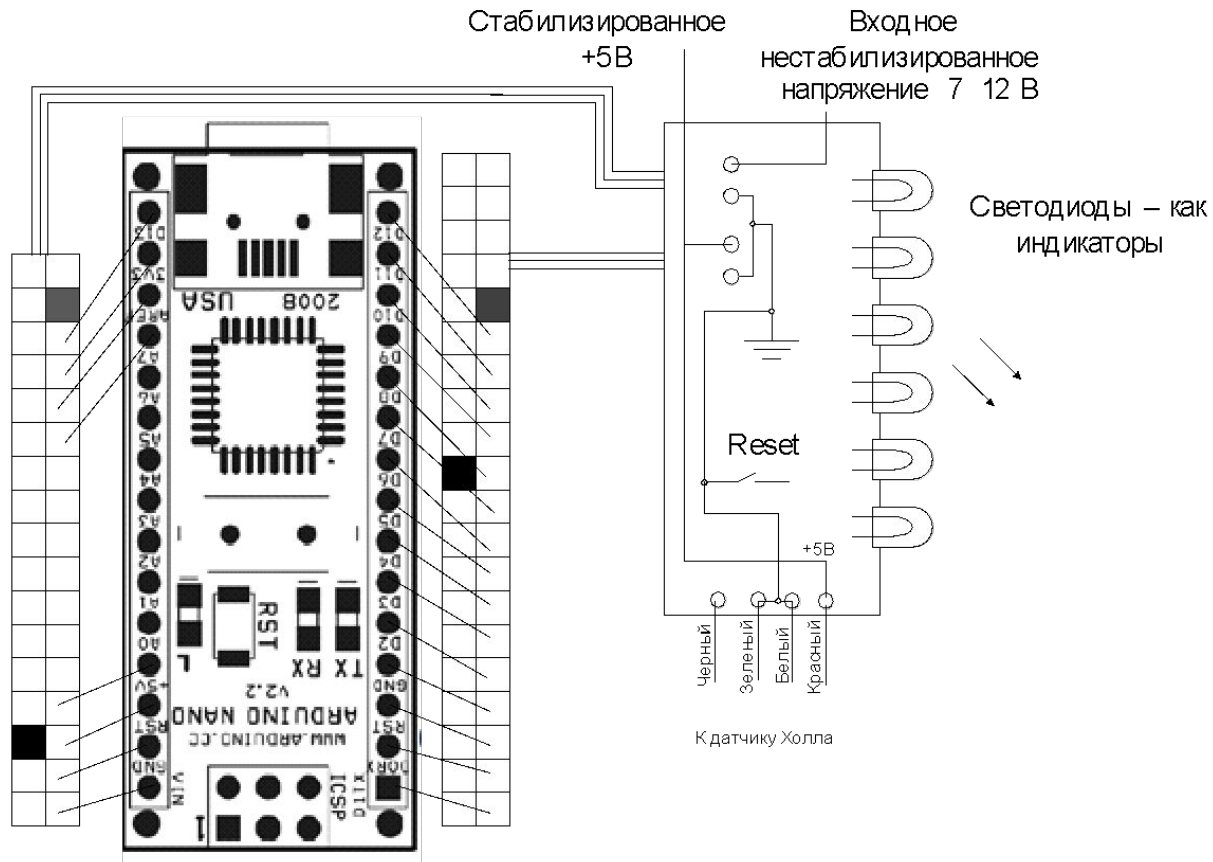



Рис. 1

Структурная схема



Рис. 2

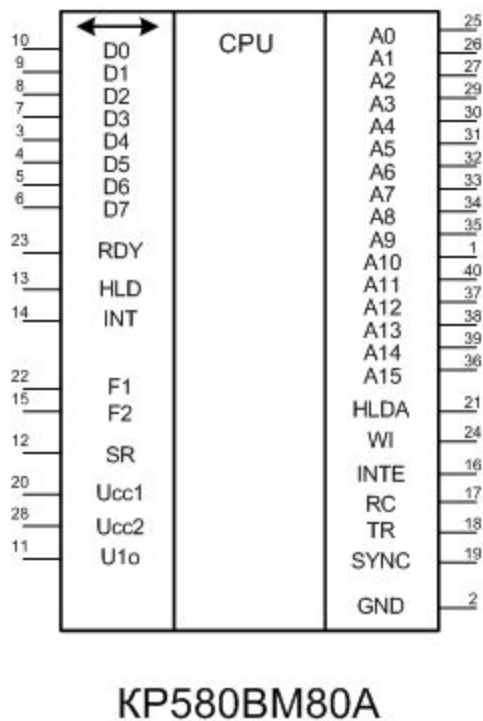

SOT-23, TO-236

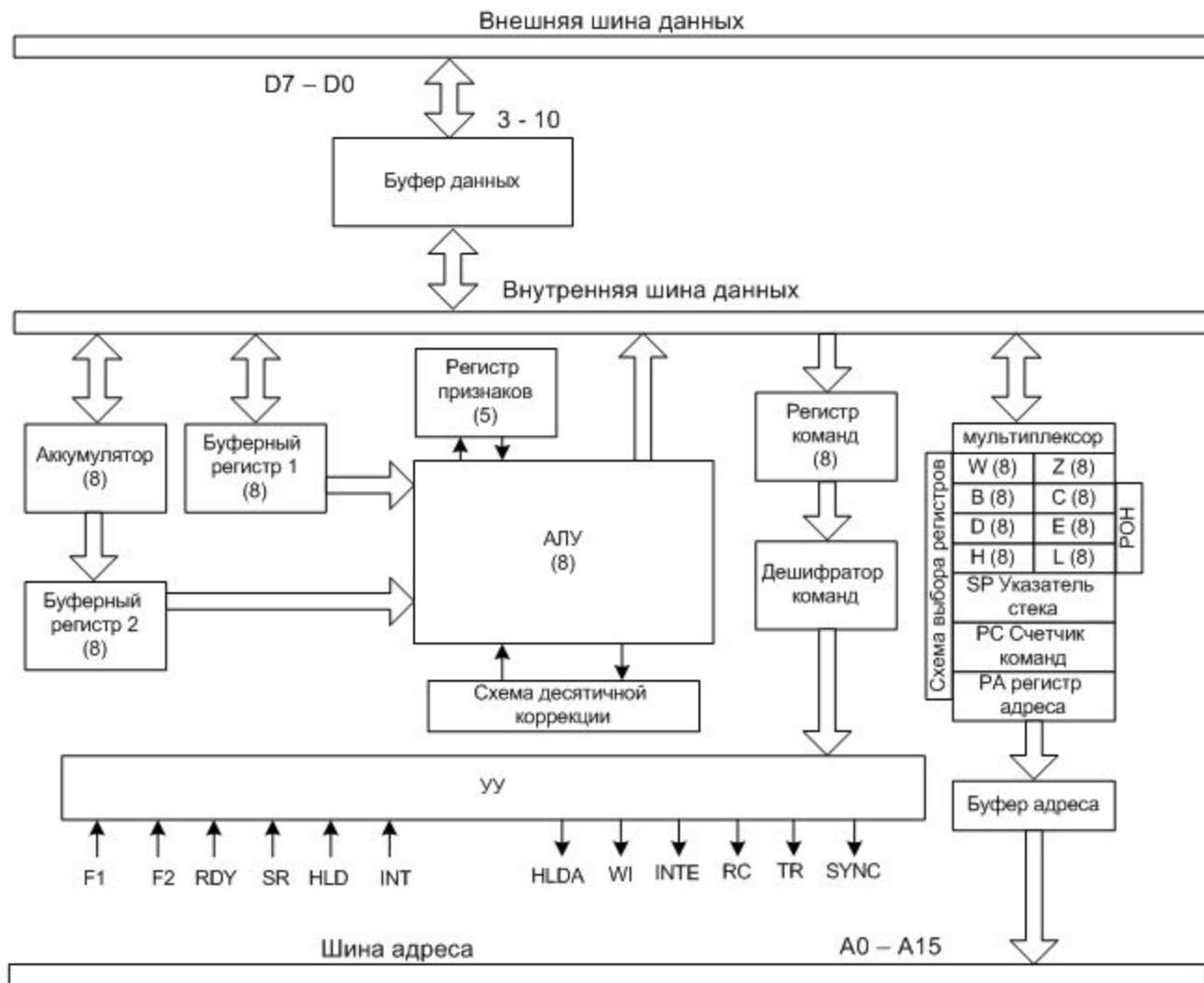

SOT-223, TO-261



SOT-89, TO-243,
HSOP-3

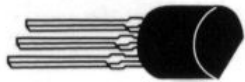

TO-92, TO-226



I-PACK, TO-251



DPAK, TO-252

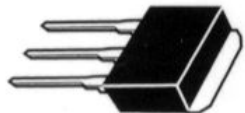

I2PAK, TO-262



D2PAK, DD,
TO-263, SMD-220

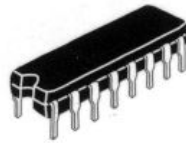

DIP, DIL, PDIP

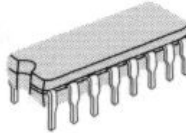

CerDIP, CDIP

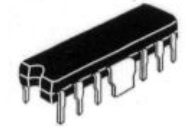

HDIP

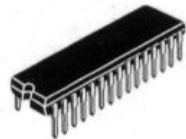

SDIP

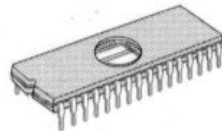

WDIP

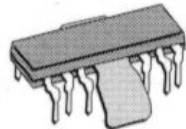

QIP

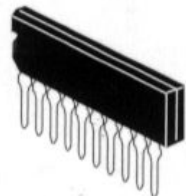

SIP



SSOP, SSOL

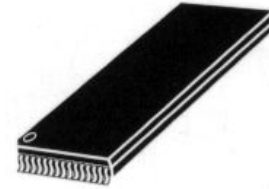

TSOP-I

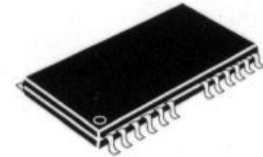

TSOP-II

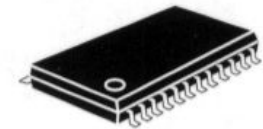

TSSOP



MSOP, Micro

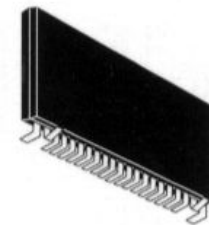

SVP

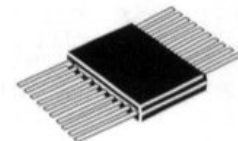

DFP, DFP-F

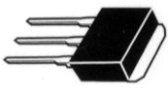

I2PAK, TO-262



D2PAK, DD,
TO-263, SMD-220

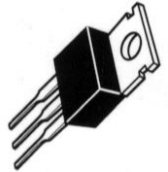

TO-220

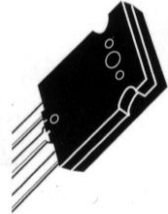

TO-3P, TO-247

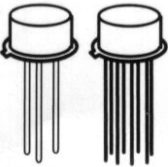

TO-46
TO-52
TO-39, TO-205
TO-5
TO-99
TO-100

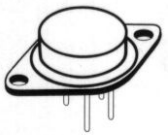

TO-8

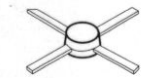

TO-66

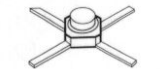

TO-3, TO-204



DB



CerDB

SMDB

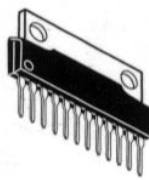

HSIP, SIP-TAB

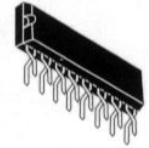

ZIP

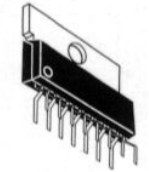

HzIP, ZIP-TAB



PGA

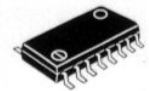

SO, SOP,
SOL, SOIC



SOJ

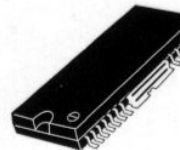

HSOP

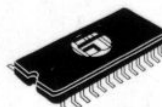

WSOP

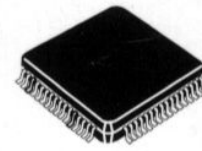

QFP, PQFP

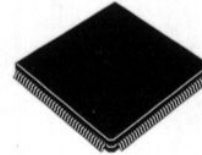

CQFP

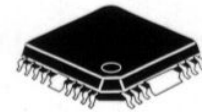

HQFP

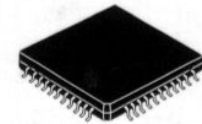

TQFP

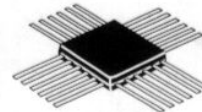

QFP-F, FPG



PLCC, QFJ

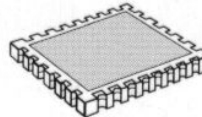

LCC

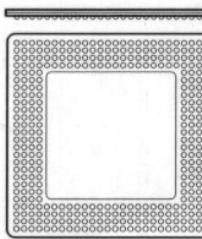

BGA



			
DFN1010-4 MLF-4 USPQ-4B03	DFN1212-6 SOT1115 DFN1212-6F SOT1202 DFN1410 SOT886	DFN1216-8 DFN2020-8 PLP2020-8	DFN1310-6
			
DFN-14 TDFN-14	DFN1411-3	DFN-16	DFN1612-4 PLP1612-4B USP-4 LLP-4 USP-4D
			
DFN1616-6 DFN1616-6B	DFN1820-6 PLP2514-6	DFN2020-6 PLP1616-6	DFN2020-B3 WBFBP-03B
			
DO-214AA DO-214AC DO-214AB DO-214BA	DO-215AA DO-215AB	DO-216	DO-219AA S-Mini SD SFP S-Mini2 SSSMini2
			
DO-220	DS-123 PowDI323 USF	ECSP1006-2T SOT-882 TSLP-2-1	EFP PMDU SCD-80 SMini2-F3 SOD-323FL SOD-523FL
			
EM3 Mini3-G1 Minit3-F1 SC-59A SC-70-3 SC-70-3L	EMT3F MCPH3 SC-89 SOT-523F SST	EMT5 ESV SMini5 SON-5 SOT-553	EMT6 HSNT-6 SMM-6 SON1612-6 HSON-6 SON-6

Socket 1156

Поддержка памяти DDR3

Поддержка процессоров:

Core i7

Core i5

Core i3

VCC Processor core power supply.

VSS Processor ground.

VTT L3 shared cache, memory

controller, and processor

I/O power rail.

VDDQ DDR3 power rail.

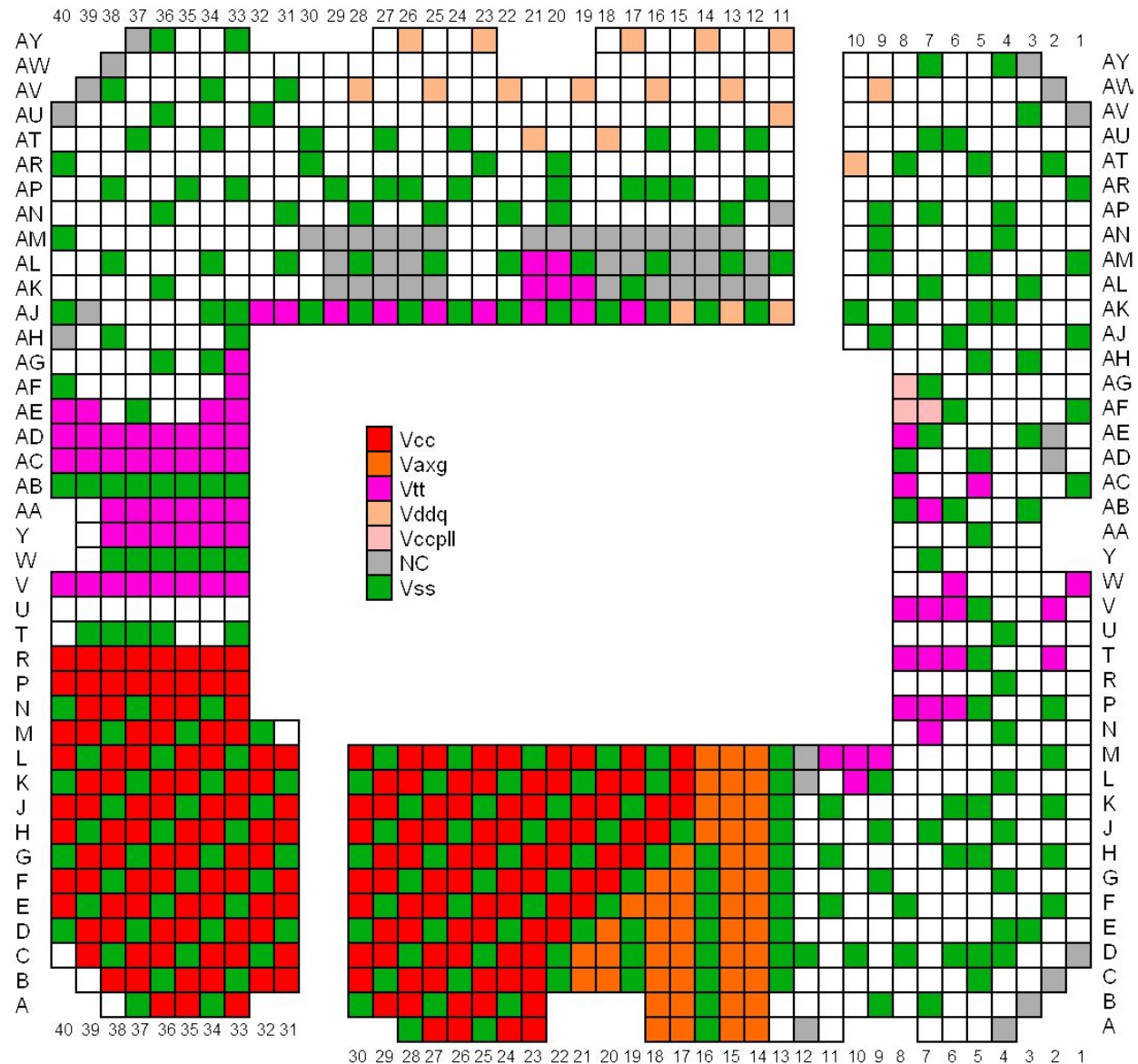

Figure 1. Intel® Core™ i7-900 Mobile Processor Extreme Edition Series, Intel Core i7-800 and Core i7-700 Mobile Processor Series Platform Diagram

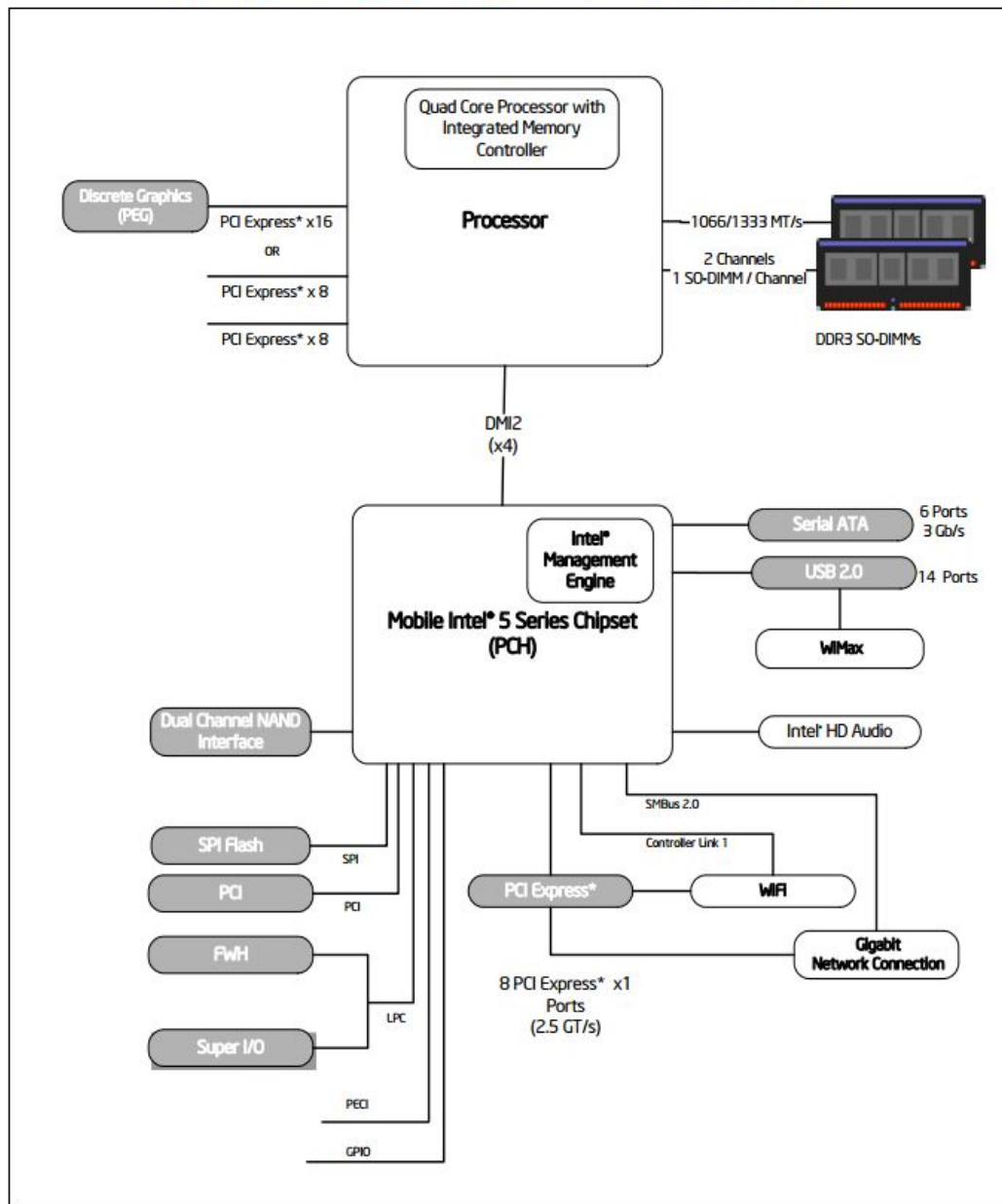

Table 36. Processor Absolute Minimum and Maximum Ratings

Symbol	Parameter	Min	Max	Unit	Notes
V_{CC}	Processor Core voltage with respect to V_{SS}	-0.3	1.45	V	1, 2, 3
V_{TT}	Voltage for the memory controller and Shared Cache with respect to V_{SS}	-0.3	1.155	V	1, 2
V_{DDQ}	Processor I/O supply voltage for DDR3 with respect to V_{SS}	-0.3	1.65	V	1, 2
V_{CCPLL}	Processor PLL voltage with respect to V_{SS}	-0.3	1.89	V	1, 2

Table 38. Processor Core (VCC) Active and Idle Mode DC Voltage and Current Specifications

Symbol	Parameter		Min	Typ	Max	Unit	Note
HFM_VID	Highest Frequency Mode VID Range		0.75		1.4	V	1,6
LFM_VID	Lowest Frequency Mode VID Range		0.65		1.0	V	1
V _{CC}	V _{CC} for processor core		See Figure 11 and Figure 12			V	1, 2, 3
TOL _{VID}	VID Tolerance		See Figure 11 and Figure 12				
I _{CCMAX}	Max Processor Core I _{CC}						
	Processor Number	Rated Frequency					
	i7-720QM	1.60 GHz			52	A	4,6,7
	i7-820QM	1.73 GHz			52		
i7-920XM	2.00 GHz			65			
I _{CC_TDC}	Thermal Design I _{CC}						
	Processor Number	Rated Frequency					
	i7-720QM	1.60 GHz			38	A	5,6,7
	i7-820QM	1.73 GHz			38		
i7-920XM	2.00 GHz			48			
I _{CC_LFM}	I _{CC} at LFM				30	A	7
I _{C6}	I _{CC} at C6 Idle-state				2	A	7
VR Step	VID resolution			12.5		mV	
SLOPE _{LL}	Processor Loadline						
	Processor Number	Rated Frequency					
	i7-720QM	1.60 GHz		-1.9		mΩ	
	i7-820QM	1.73 GHz		-1.9			
i7-920XM	2.00 GHz		-1.6				
Non-VR LL contribution	Non-VR Loadline Contribution for V _{CC}			-0.9		mΩ	

Figure 11. Active V_{CC} and I_{CC} Loadline (PSI# Asserted)

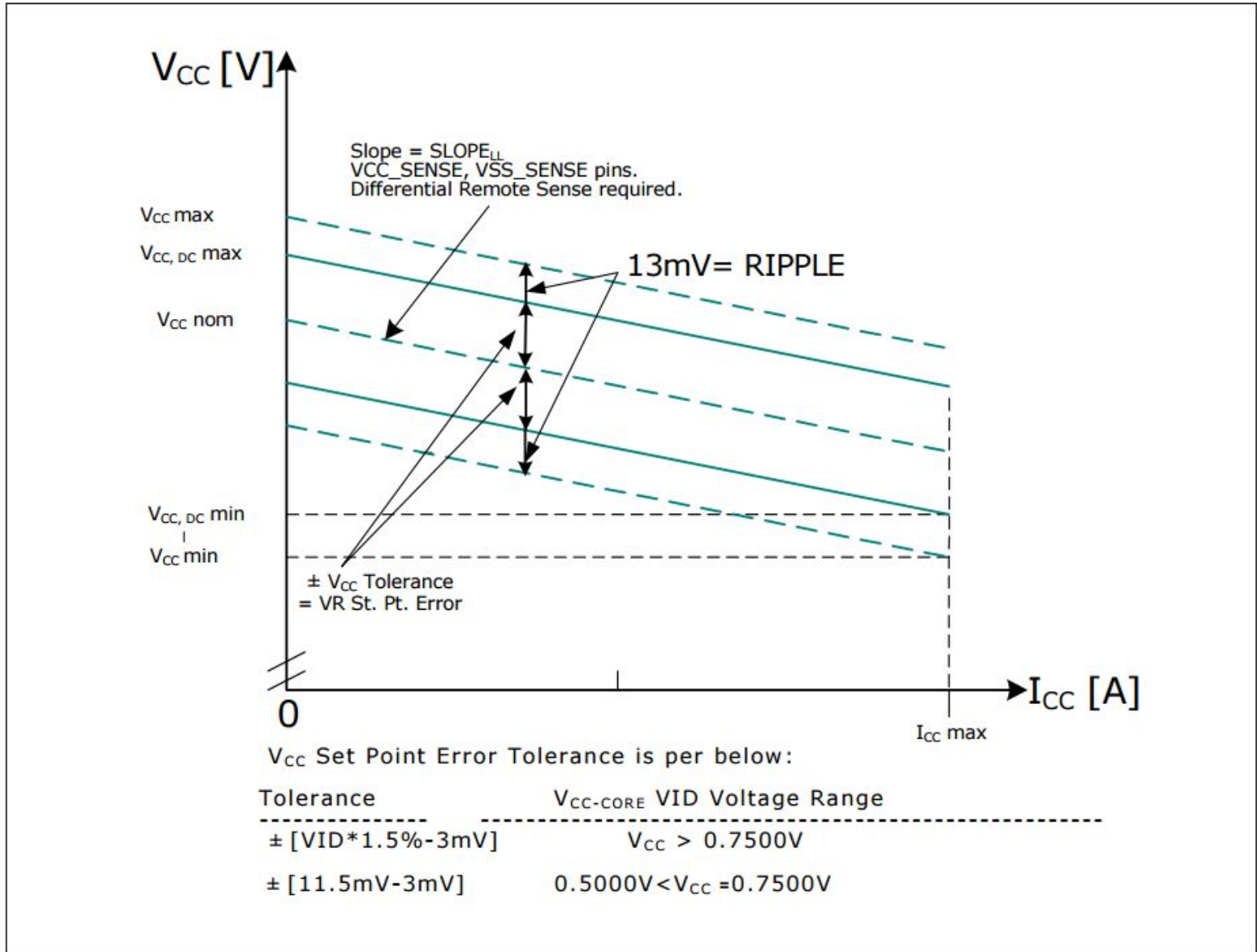

Table 39. Processor Uncore I/O Buffer Supply DC Voltage and Current Specifications

Symbol	Parameter	Min	Typ	Max	Unit	Note
V _{TT}	Voltage for the memory controller and shared cache at the socket motherboard V _{TT} pinfield via	1.045	1.10	1.155	V	1
	Voltage for the memory controller and shared cache defined across V _{TT_SENSE} and V _{SS_SENSE_VTT}	1.023	1.10	1.177	V	2
TOL _{TT}	V _{TT} Tolerance defined at the socket motherboard V _{TT} pinfield via	DC: ±2 AC: ±3 including ripple			%	1
	V _{TT} Tolerance defined across V _{TT_SENSE} and V _{SS_SENSE_VTT}	DC: ±2 AC: ±5 including ripple			%	2
I _{CCMAX_VTT}	Max Current for V _{TT} Rail Intel® Core™ i7-800 and i7-700 mobile processor series Intel Core i7-900 mobile processor extreme edition series			18 21	A	3
I _{CCTDC_VTT}	Thermal Design Current (TDC) for V _{TT} Rail Intel Core i7-800 and i7-700 mobile processor series Intel Core i7-900 mobile processor extreme edition series		-	17 20	A	3
V _{DDQ}	Processor I/O supply voltage for DDR3 (DC + AC specification)	1.425	1.5	1.575	V	
TOL _{DDQ}	V _{DDQ} Tolerance	DC= ±3 AC= ±2			%	
I _{CCMAX_VDDQ}	Max Current for V _{DDQ} Rail		-	6	A	
I _{CCTDC_VDDQ}	Thermal Design Current (TDC) for V _{DDQ} Rail		-	5	A	
I _{CCAVG_VDDQ} (Standby)	Standby Current for V _{DDQ} Rail i		-	0.5	A	
V _{CCPLL}	PLL supply voltage (DC + AC specification)	1.710	1.8	1.890	V	
TOL _{CCPLL}	V _{CCPLL} Tolerance	AC+DC= ±5%			%	
I _{CCMAX_VCCPLL}	Max Current for V _{CCPLL} Rail		-	1.1	A	
I _{CCTDC_VCCPLL}	Thermal Design Current (TDC) for V _{CCPLL} Rail		-	0.7	A	

