

BNR ASC Training

ASC name

Location, date

- Review of BNR principles, modules, and basic operations
- Overview of the BNR technical documentation
 - BNR Service manual, BNR User Manual, BNR Integration Manual, BNR Specifications
- Other BNR resources
- The BNR Support Tool and its functions
- The BNR Flash Tool
- Overview of BNR Servicing and Maintenance
 - ASC System / Process

- BNR diagnostics, troubleshooting, error reporting
- BNR Testing
 - BNR inspection checklist (before repair), BNR testing procedures (after repair)
- BNR servicing and maintenance
- Hints and review of jam clearing
- CPI Service Management and its importance
- BNR Spare parts
- BNR Web site & FTP site and CPI periodic communications (new FW releases, bulletins, etc.)

- BNR Repair workshop: modules disassembly
 - Resources: the BNR Repair Guide and Repair videos
 - Loader (full module disassembly)
 - Chassis
 - Spine
 - Main Module

- BNR Repair workshop: modules adjustments and other service procedures
 - Bundler Slippage Calculation
 - Main Module Diverter Adjustment
 - Recycler Tape Cleaning & Adjustment
 - Main Module calibration
 - BNR Modules testing procedures

Review of BNR basic principles, BNR modules and BNR basic operations

- BNR Modules
- BNR codification, the BNR family
- How BNR processes the bills



Final Bill Flow w narration.wmv

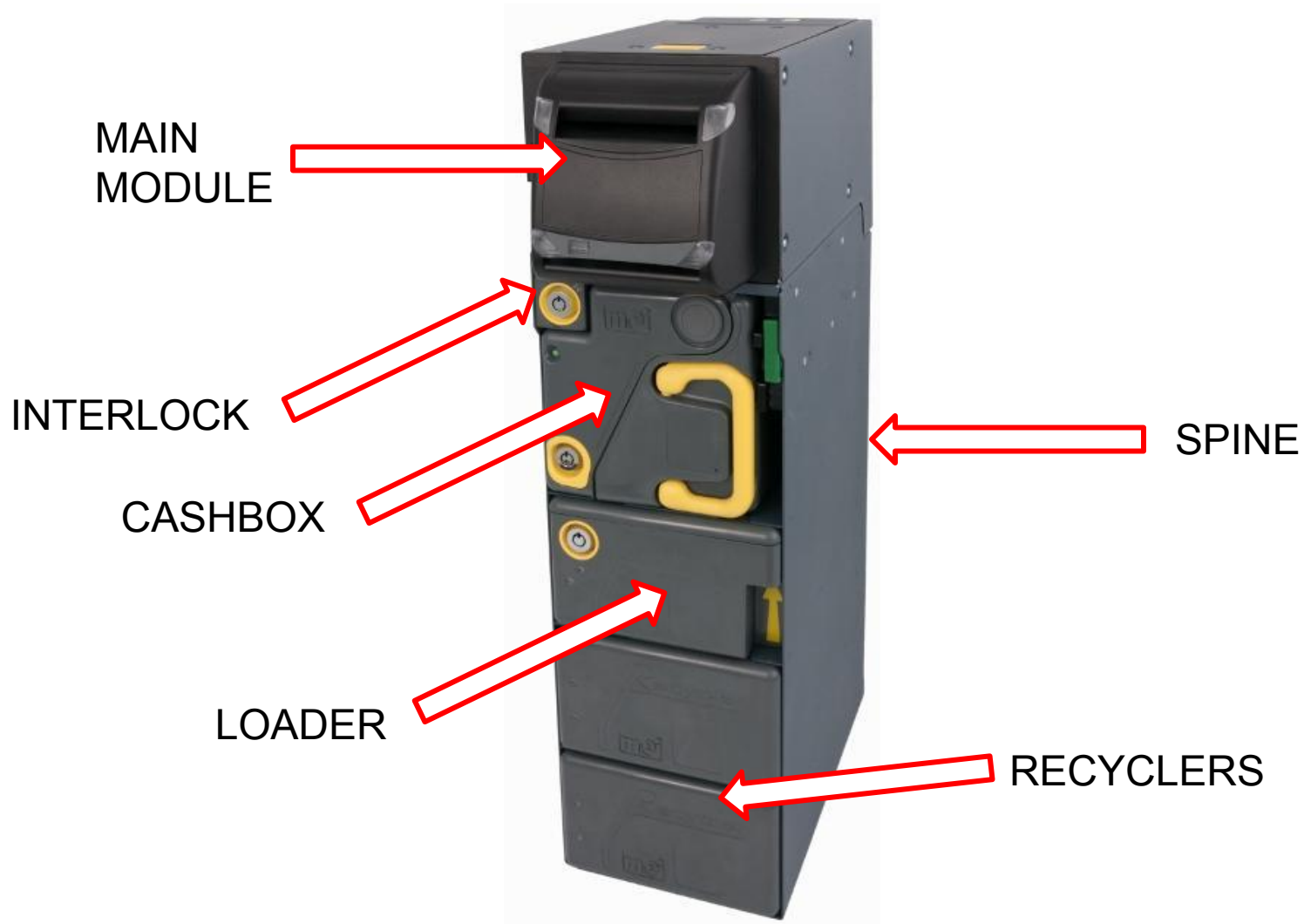

Model Versioning

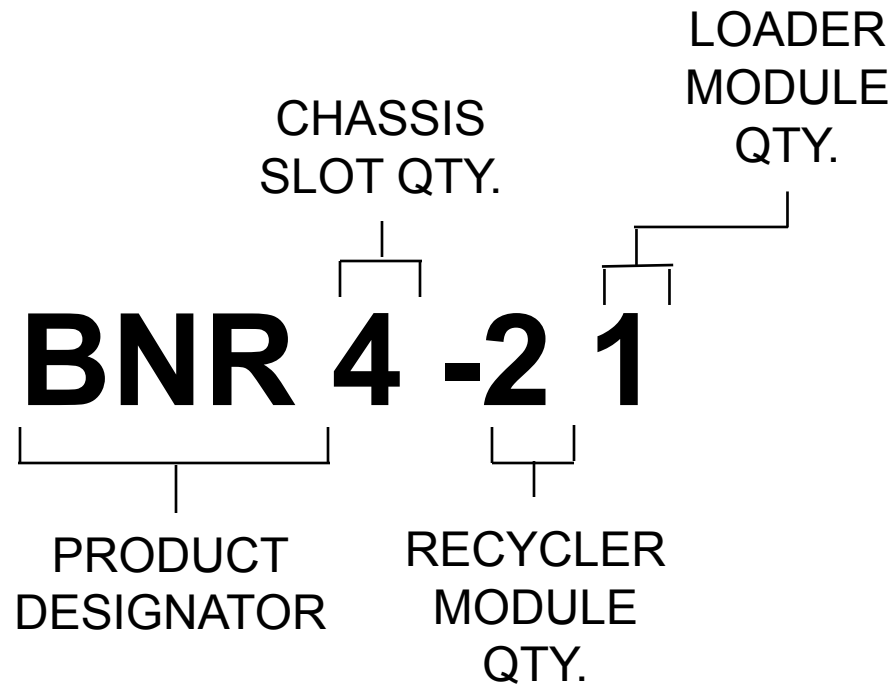

BNR4-21



BNR4-11



BNR4-20



BNR4-10



BNR3-11



BNR3-20



BNR3-10



BNR3-00



- Module Serial Number (MSN)
- CTO Serial Number (CTO)

Understanding Serial Numbers

- All Serial Numbers are 11-digit
- Example: MSN# 09491300086 (Main Module)

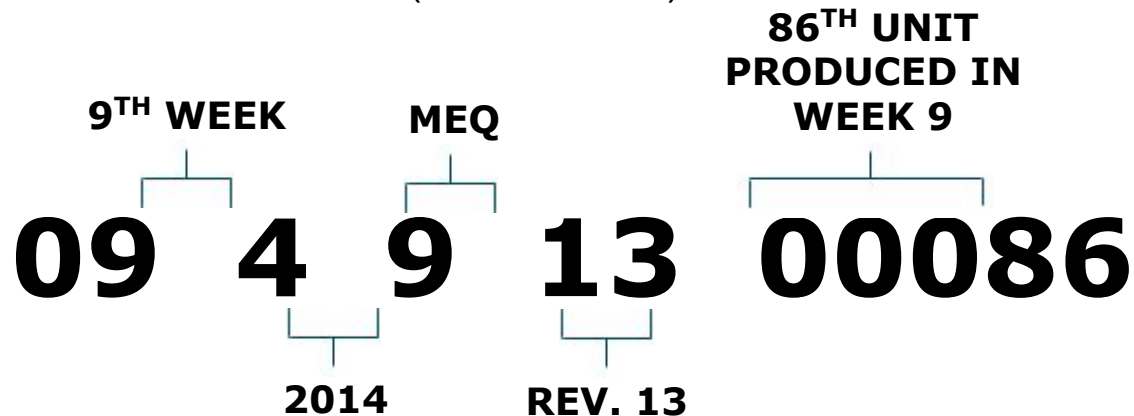

Review of BNR principles and modules

■ Modules and sub-modules designation

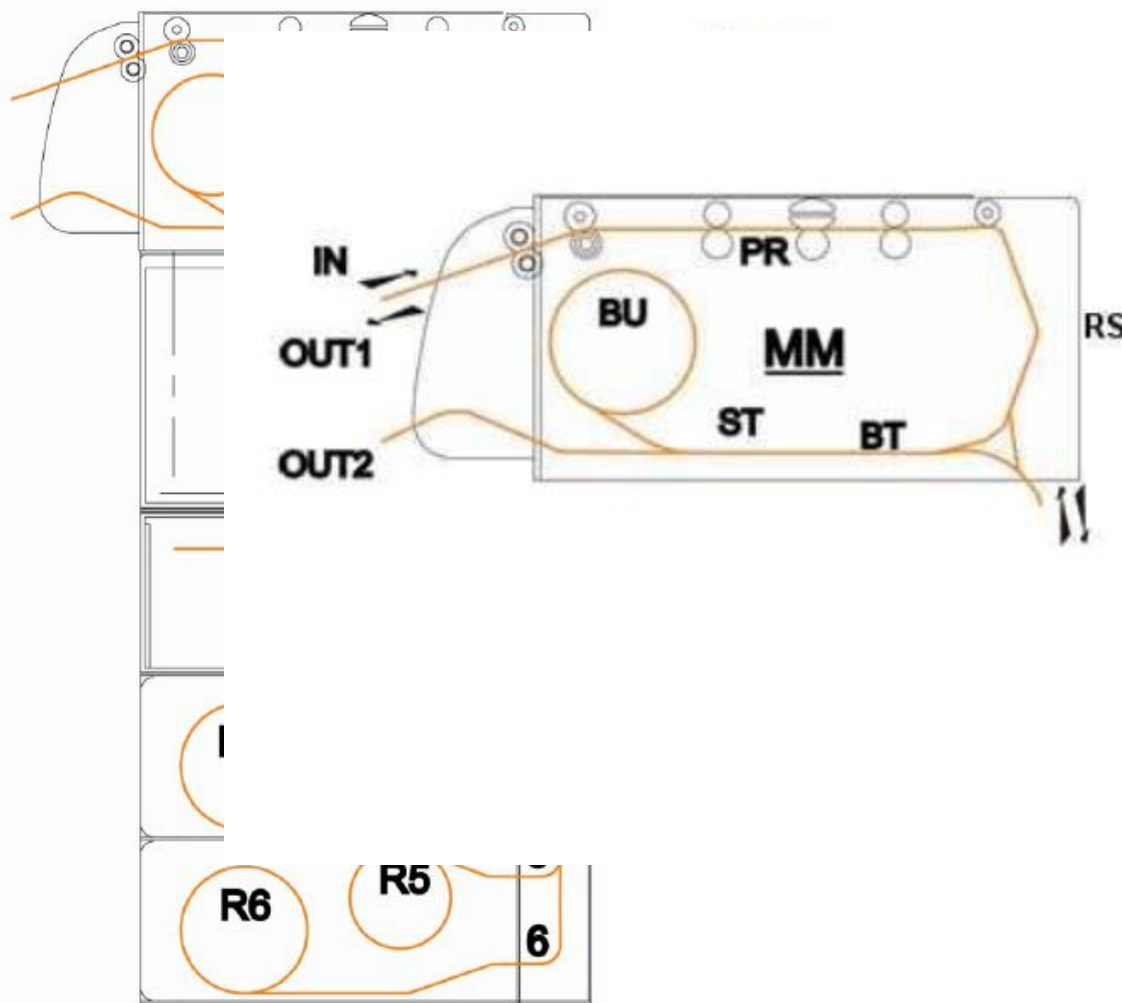

  **BNR Service Manual**

MM =	Main Module
IN =	Inlet for banknote insertion
OUT1 =	Outlet for banknote rejection
OUT2 =	Outlet for banknote return or dispense
PR =	Positioner
RS =	Recognition Sensors (Reading Heads)
BT =	Bottom Transport
ST =	Stacker
BU =	Bundler
 =	Banknote path

BNR technical documentation overview

BNR Product Specifications

Every possible nominal value that identifies and describes the BNR characteristics and performance, including: system codification, EMC compliancy, power supply, mounting, validation parameters, expected life, expected performance (MCBJ), cleaning intervals, etc.



BNR Integration Manual

Includes: BNR naming and codification, banknotes processing, mechanical and electrical integration, mounting options, SW integration, Support Tool .zconf file for FW update through Flash Tool, etc.



BNR User Guide

Includes: modules basic handling, BNR LEDs and troubleshooting codes, Easy Jam clearing

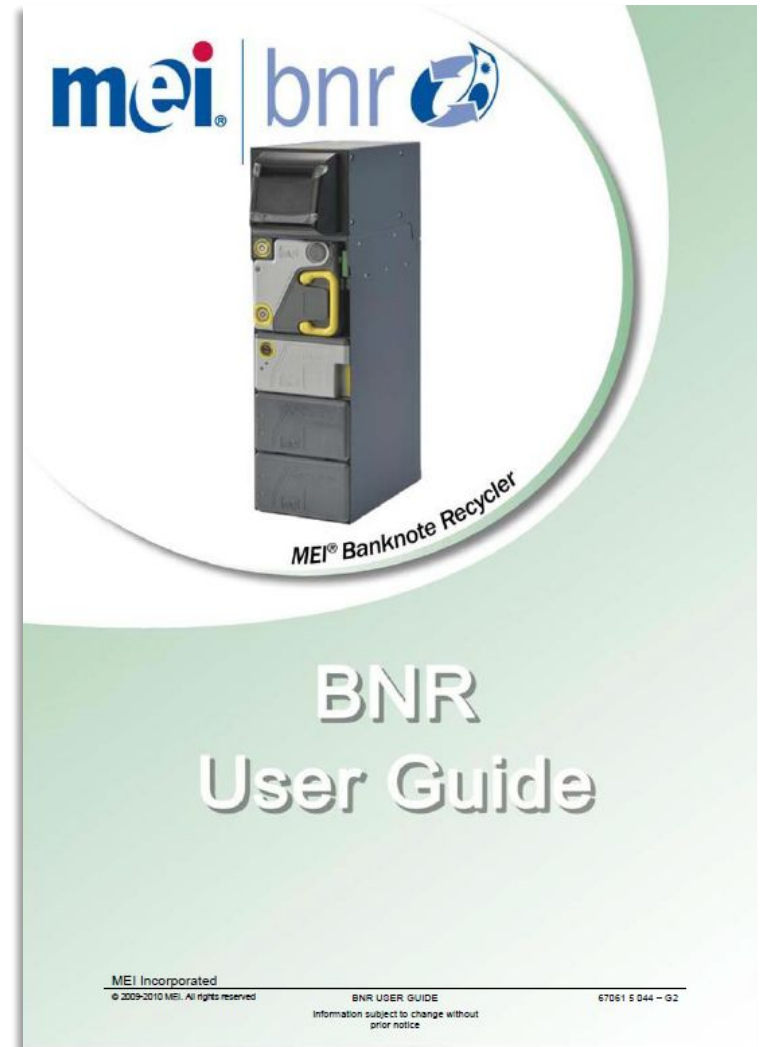

BNR Service Manual

Includes: unpacking the BNR and mounting, getting started with the ST, advanced jam clearing, preventive maintenance reco, cleaning instructions, basic disassembling (exchanging modules and basic parts)



Other Documentation and Resources

- BNR Official Training Videos
- BNR “How to...” Files (Unofficial)
- BNR Sensors and Troubleshooting Diagrams
- BNR Repair and Maintenance Guide
- BNR Troubleshooting Guide (Unofficial)
- BNR Fault Code Spreadsheet (Unofficial)
- BNR Spare Parts Catalogue

The BNR Support Tool

The powerful tool that serves every purpose on the BNR:

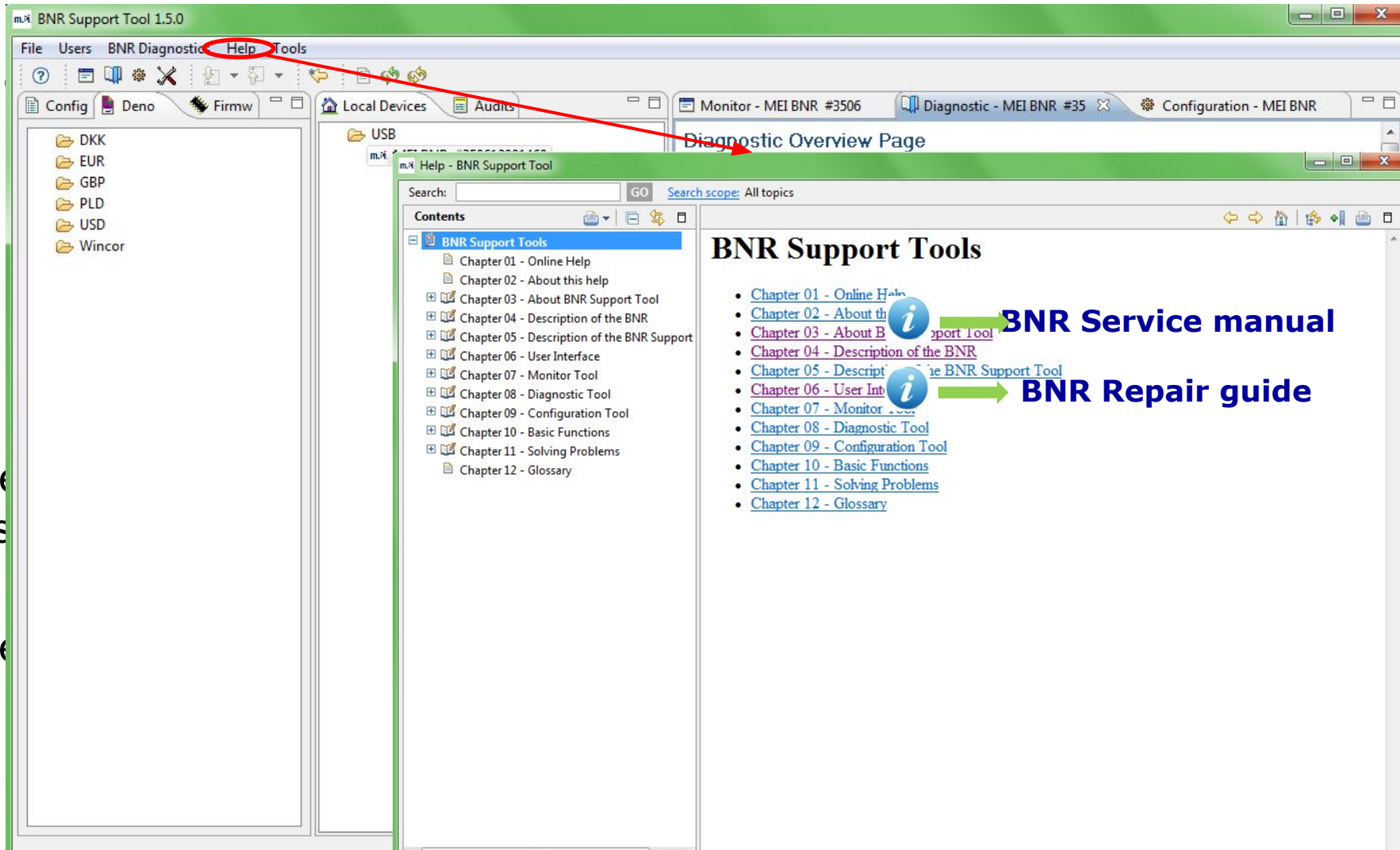

The screenshot displays the BNR Support Tool 1.5.0 interface. The 'Help' menu is circled in red, and a red arrow points to the 'Diagnostic Overview Page' window. The 'Help - BNR Support Tool' window is open, showing a search bar and a table of contents. The table of contents lists 12 chapters, with 'Chapter 01 - Online Help' and 'Chapter 06 - User Interface' highlighted. Green arrows point from these chapters to the text 'BNR Service manual' and 'BNR Repair guide' respectively.

BNR Support Tools

- [Chapter 01 - Online Help](#)
- [Chapter 02 - About this help](#)
- [Chapter 03 - About BNR Support Tool](#)
- [Chapter 04 - Description of the BNR](#)
- [Chapter 05 - Description of the BNR Support Tool](#)
- [Chapter 06 - User Interface](#)
- [Chapter 07 - Monitor Tool](#)
- [Chapter 08 - Diagnostic Tool](#)
- [Chapter 09 - Configuration Tool](#)
- [Chapter 10 - Basic Functions](#)
- [Chapter 11 - Solving Problems](#)
- [Chapter 12 - Glossary](#)

BNR Service manual

BNR Repair guide

Chapter
bas

Chapter
BN

Support Tool Demonstration

- “Diagnostics” Tool
 - Troubleshooting and Analytic Purposes
- “Configuration” Tool
 - Creating and Applying Unit Configurations
- “Monitor” Tool
 - Bill Handling and Unit Operations

Use the BNR Support Tool to...

- Add/download bills
- Delete bills
- Generate and save a diagnostic file
- Park recyclers
- Add a cash unit module and set it
- Inhibit/activate bills
- Download FW
- Point to the proper FW/Billset/Audit Repositories
- Create a Configuration File



BNR "How to" files

“Unofficial” Document Explaining How-to



BNR DIAGNOSTIC COLLECTION PROCEDURE

Below is a detailed procedure regarding the collection of diagnostic files via the BNR Support Tool:

- 1) Ensure that the unit is powered correctly via the host or other external power source
- 2) Disconnect the USB / NCR cable from the host
- 3) Power up your PC and open the BNR Support Tool
 - a. Username: admin / Password: admin



- 4) At the next pop-up (below) select “Direct Access” from the two options provided.



The BNR Flash Tool

- Very simple to use, once zconf file is
- Specific manual is provided
- Examples on how to create and use a

 → **BNR User manual**

 → **BNR "How to..."**

The BNR Flash Tool



MEI BNR
Banknote Recycler

BNR Flash utility
User manual

Release G4

BNR diagnostics, troubleshooting and error reporting

- BNR diagnostics LEDs
- BNR Support Tool and diagnostic file
- Proper documentation: BNR troubleshooting Guide and
- BNR Sensors diagrams
-experience

LEDs codes for basic troubleshooting

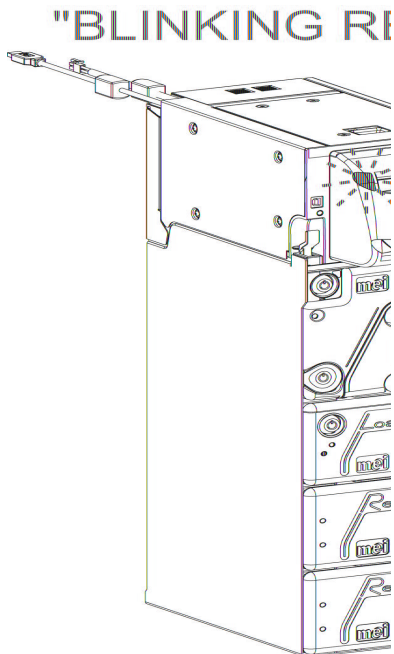

[BNR User Manual](#)

External Indicator – FW version 1.0.0		System / Module Status	You need to
		Locked	Take no action After Switch-on, have the BNR to 'Reset'
		"Reset" required	Take no action (CB ready to insert)
		Operational	Fill the Loader Cassette with banknotes
		Bill Storage not OK (Loader only)	Configure the Module
		Cash type Status not OK (Re, Lo)	Clear the Jam, refer to "EASY JAM CLEARING" or refer to the Service Manual
		Remove Bill in Transport (jam, stopped, bill error)	Require a "Reset" command
		Not Operational (wrong module, OOS, transport error)	Empty the CB, rearmmed it, refer to "CASH-BOX HANDLING"
		Cash-Box full or not rearmmed	

BNR4-21 (Modules & Functional Elements)

The BNR modules and functional elements diagram

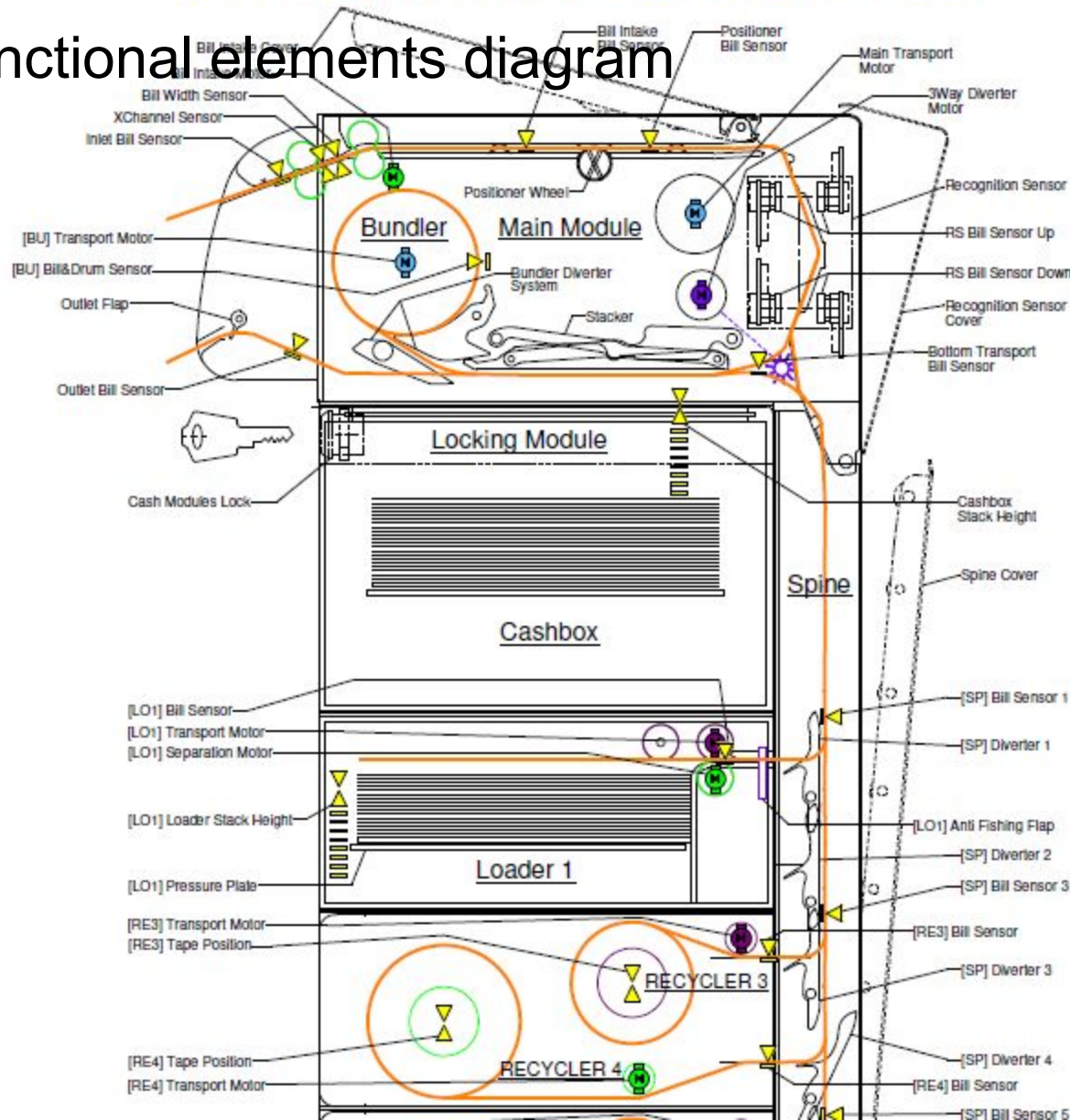

The BNR sensors diagram

Main Module

Distances dans le Bille (mm)	
BL.S1 - BL.S2	22.6
BL.S2 - BL.S3	4.3 - 7.3
BL.S3 - BL.S4	95.3
BL.S4 - BL.P1	116.0
BL.P1 - BL.P2	27.3

Distances dans le Pneu (mm)	
HL.S1 - HL.S2	22.5
HL.S2 - HL.S3	56.3
HL.S3 - SP.P1	42.4
HL.S3 - BT.S1	37.0

Distances dans le Spine (mm)	
SP.P1 - SP.P2	23.7
SP.P1 - SP.P11	168.0
SP.P11 - SP.S12	1.8
SP.S12 - SP.P12	44.8
SP.P12 - SP.P13	36.3
SP.S12 - SP.S22	26.5
Hauteur module	

Distances dans le Bottom transport (mm)	
BT.S1 - BT.S1	20.1
BT.S1 - BT.P1	10.8
BT.S1 - BT.P3	195.7
BT.S1 - BT.P4	202.1
BT.S1 - BT.S2	237.0
BT.S2 - BT.P12	2.0
BT.S2 - BT.S3	32.4
BT.S1 - BU.P2	152.8
BT.S1 - BU.P6	194.7
BT.S2 - BT.P5	16.4

Angles et distances dans le Bundler sans bille (- & mm)		
Circuit Bundler	360°	229.3
BU.S1 - BU.P3	103.6°	63.7
BU.S1 - BU.P4	107.6°	68.7
BU.S1 - BU.P5	42.6°	27.3
BU.P2 - BU.P6		42.0

Distances à l'interface de module (mm)	
SP.S1 - SP.P13	26.4
SP.S2 - SP.P14	42.1
SP.S2 - SP.P15 +102	122.2
SP.S1 - SP.P15 +102	82.4

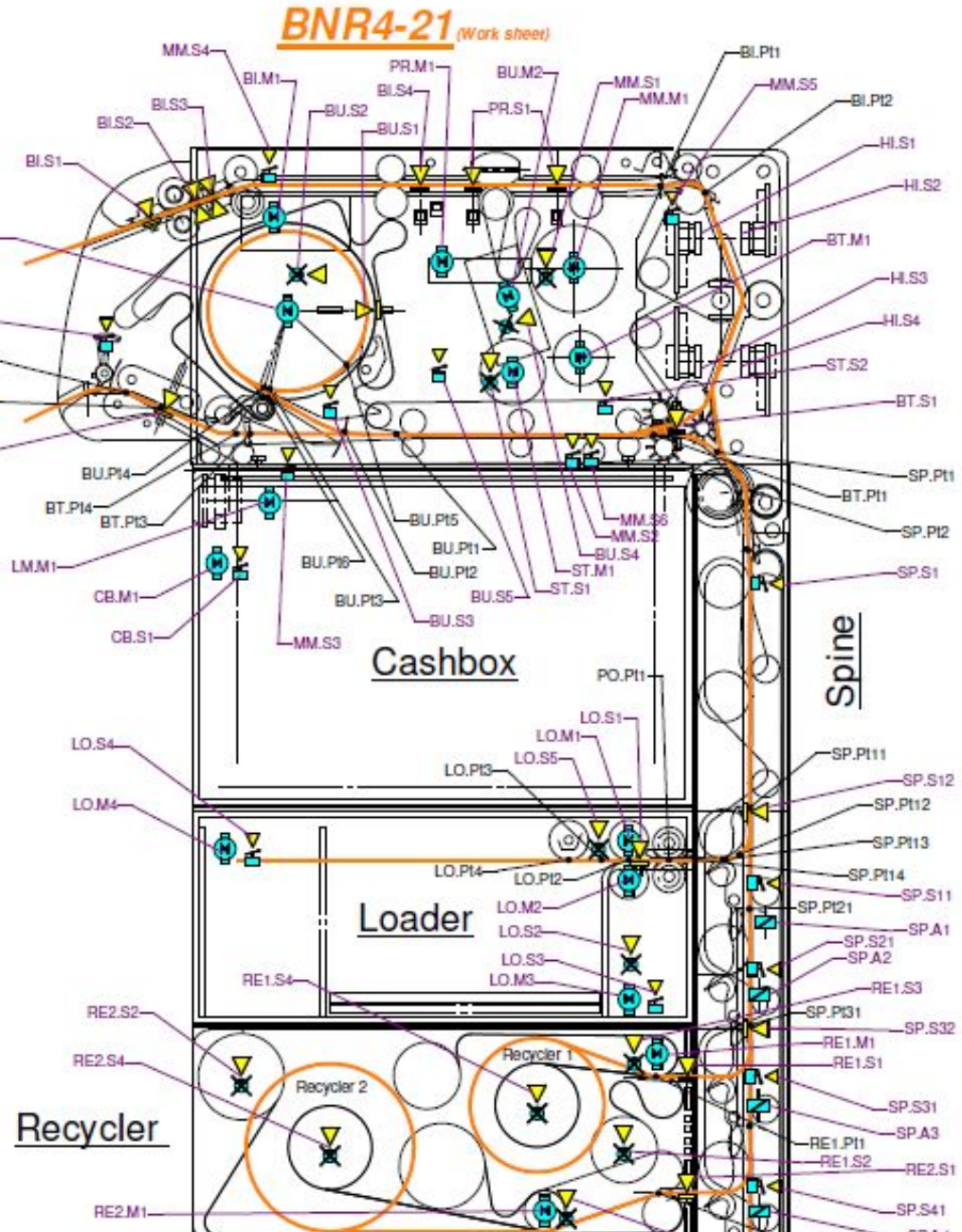



The BNR Troubleshooting guide

A powerful guide to the BNR troubleshooting (still to be officially released)

MEI® BNR Banknote Recycler

BNR Troubleshooting Guide

Release R1

The BNR Troubleshooting guide

Provides the link between the info visible at ST and the corrective action. The info it provides is mainly at Service Technician level, but the indications can be useful also at ASC level to help locate and identify the issue.

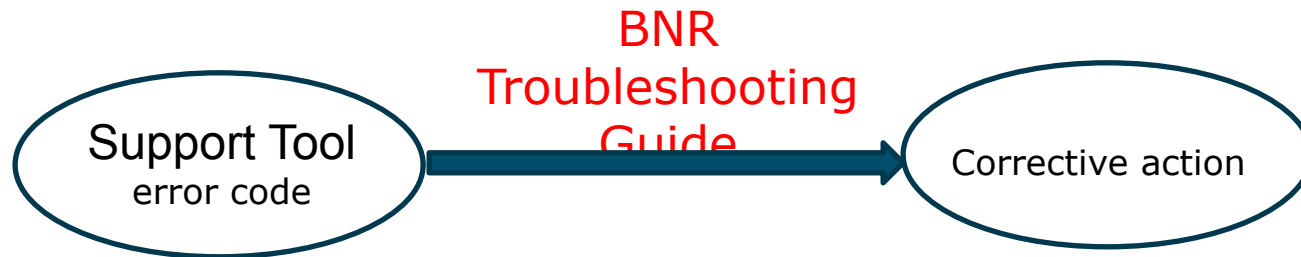

Let's make an example !

This BNR unit is not operational, where is the issue ?

Diagnostic - Desktop\#350612001460_130806_182751_mio.mei

Diagnostic Overview Page

Expand Collapse

Diagnostic file Information **BNR diagnostic file**

User Information

Customer Information

Status Information

XFS Status	
Device Status	DEVICE HARDWARE ERROR (6174)
Dispenser Status	DISPENSER CU STATE (6182)
Intermediate Stacker Status	INTERMEDIATE STACKER EMPTY (6185)
Safe Door Status	SAFE DOOR LOCKED (6196)
Shutter Status	SHUTTER CLOSED (6198)
Transport Status	TRANSPORT OK (6203)

System Status	
operationalStatus	NOT OPERATIONAL (2) ❌
errorCode	NO ERROR (0)
billTransportStatus	OK (0)
billStorageStatus	WARNING (4) ⚠️
cashTypeStatus	OK (1)

positionStatuses

positionStatus 1	
shutterStatus	SHUTTER NOT SUPPORTED (6201)
contentStatus	EMPTY (0)

positionStatus 2	
shutterStatus	SHUTTER CLOSED (6198)
contentStatus	EMPTY (0)

Application Components Overview

Package version:

In comparison to the package version	1.7.1	BNR firmware is up to date	FALSE
--------------------------------------	-------	----------------------------	-------

Overview **Main Module** Bundler Module Spine Module Loader-1 Recycler-3 Recycler-4 Recycler-5 Recycler-6 CashBox Module

locate the faulty module...

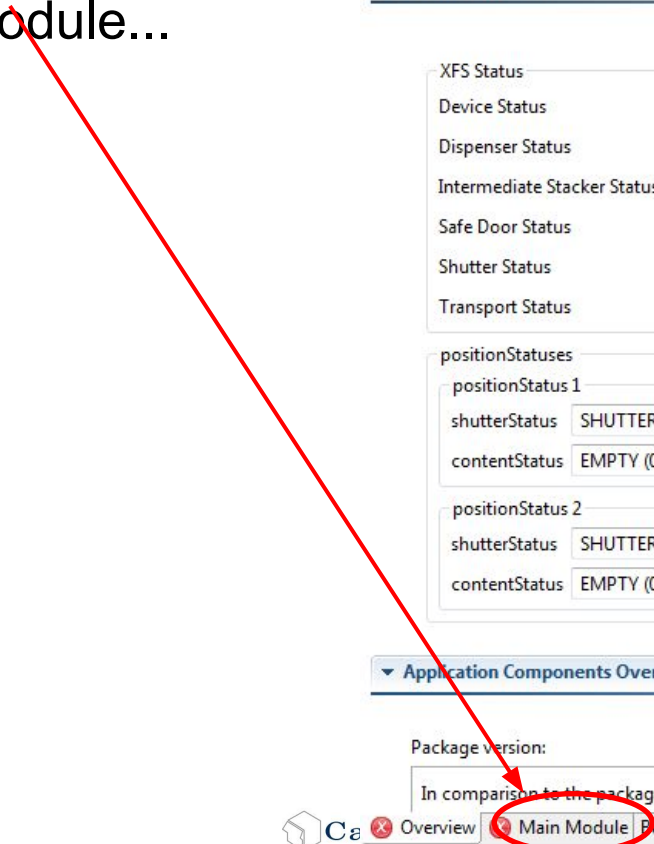

Which element i

...locate the faulty element
inside the Module...

Diagnostic - Desktop\#350612001460_130806_182751_mio.mei X

User Data:

▼ **Module Status MAIN_MODULE**

operationalStatus	NOT OPERATIONAL (2)	✖
errorCode	NO ERROR (0)	
billTransportStatus	OK (0)	
billTransportSection	UNKNOWN (0)	

▶ Element Status (INLET_BILL_SENSOR)

▶ Element Status (CHANNEL_SENSOR)

▶ Element Status (BILL_WIDTH_SENSOR)

▶ Element Status (BILL_INTAKE_BILL_SENSOR)

▶ Element Status (POSITIONER_BILL_SENSOR)

▶ Element Status (BOTTOM_TRANSPORT_BILL_SENSOR)

▶ Element Status (OUTLET_BILL_SENSOR)

▶ Element Status (BILL_INTAKE_COVER)

▶ Element Status (RECOGNITION_SENSOR_COVER)

▶ Element Status (BILL_INTAKE_MOTOR)

▶ Element Status (MAIN_TRANSPORT_MOTOR)

▶ Element Status (THREE_WAY_DIVERTER_MOTOR)

▶ Element Status (STACKER)

▶ Element Status (BUNDLER_DIV_SYSTEM)

▶ **Element Status (RECOGNITION_SENSOR)**

▶ Element Status (POSITIONER_WHEEL)

▶ Element Status (CASHBOX_STACK_HEIGHT)

▶ Element Status (OUTLET_FLAP)

Overview Main Module Bundler Module Spine Module Loader-1 Recycler-3 Recycler-4 Recycler-5 Recycler-6 CashBox Module

Which is the code/description of the issue ?

...and its error code

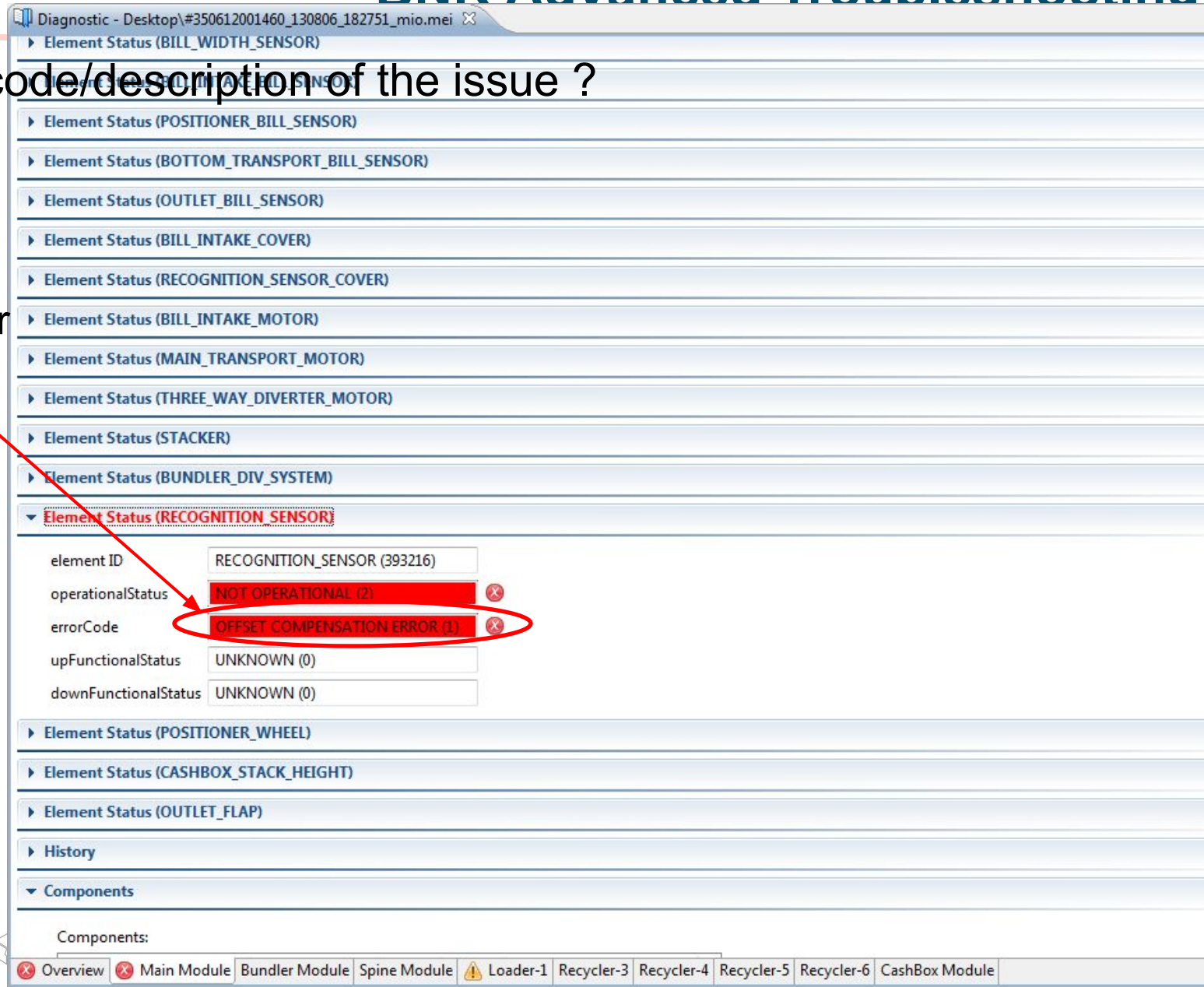

Diagnostic - Desktop\#350612001460_130806_182751_mio.mei

- Element Status (BILL_WIDTH_SENSOR)
- Element Status (POSITIONER_BILL_SENSOR)
- Element Status (BOTTOM_TRANSPORT_BILL_SENSOR)
- Element Status (OUTLET_BILL_SENSOR)
- Element Status (BILL_INTAKE_COVER)
- Element Status (RECOGNITION_SENSOR_COVER)
- Element Status (BILL_INTAKE_MOTOR)
- Element Status (MAIN_TRANSPORT_MOTOR)
- Element Status (THREE_WAY_DIVERTER_MOTOR)
- Element Status (STACKER)
- Element Status (BUNDLER_DIV_SYSTEM)
- Element Status (RECOGNITION_SENSOR)**
 - element ID: RECOGNITION_SENSOR (393216)
 - operationalStatus: NOT OPERATIONAL (2)
 - errorCode: **OFFSET_COMPENSATION_ERROR (1)**
 - upFunctionalStatus: UNKNOWN (0)
 - downFunctionalStatus: UNKNOWN (0)
- Element Status (POSITIONER_WHEEL)
- Element Status (CASHBOX_STACK_HEIGHT)
- Element Status (OUTLET_FLAP)
- History
- Components
 - Components:

Overview Main Module Bundler Module Spine Module Loader-1 Recycler-3 Recycler-4 Recycler-5 Recycler-6 CashBox Module

Now we take the BNR Trout

Look for the faulty element
and

- errorCode:
NO_ERROR (0)

BLOCKED (1): The bundler diverter system motor's speed was null or too low.
CANNOT_POSITION (2): The bundler diverter system failed to reach the requested position.
EXTRACTION_POS_NOT_CONFIRMED (3): The bundler diverter system position confirmation sensor (BU.S3) should have been covered on extraction position.
OUTLET_POS_NOT_CONFIRMED (4): The bundler diverter system position confirmation sensor (BU.S3) should have been covered on outlet position.
CANNOT_FIND_MARK (5): The bundler diverter system could not find the position mark during initialisation cycle.

SOLUTION: 1) Advanced Field Operator: remove cashbox. Remove unexpected object (if any) in the Bundler area. Secure BNR.
2) Host: send Reset command.
If problem persists:
3) Field Service Technician: Main Module needs to be repaired.

3.11 Recognition Sensor

Element Status (RECOGNITION_SENSOR)	
element ID	RECOGNITION_SENSOR (393216)
operationalStatus	OPERATIONAL (0)
errorCode	NO ERROR (0)
upFunctionalStatus	UNKNOWN (0)
downFunctionalStatus	UNKNOWN (0)

- operationalStatus:
OPERATIONAL (0): The module or element is operational. No errors

CHECKING_ERROR (1): Cannot determine operational state of the module. Will be determinate on next test.

SOLUTION: Host: Send Reset command

3.11 Recognition Sensor

Element Status (RECOGNITION_SENSOR)	
element ID	RECOGNITION_SENSOR (393216)
operationalStatus	OPERATIONAL (0)
errorCode	NO_ERROR (0)
upFunctionalStatus	UNKNOWN (0)
downFunctionalStatus	UNKNOWN (0)

...the error code

SUGGESTED ACTION

is provided

- **operationalStatus:**
 OPERATIONAL (0): The module or element is operational. No errors

 CHECKING_ERROR (1): Cannot determine operational state of the module. Will be determined on next test.
SOLUTION: **Host:** Send Reset command

 NOT_OPERATIONAL (2): Module not operational. Module or sub-module part has an error. Refer to **errorCode**
- **errorCode:**
 NO_ERROR (0)
 OFFSET_COMPENSATION_ERROR (1): Impossible to compensate the offset.
 REMAINING_OFFSET_TOO_LOW (2): The remaining offset is too low.
 C_COEF_DIV_BY_ZERO (5): Divide by zero while calculating C coefficients.
 C_COEF_NEG_VALUE (6): One or more c coefficients are below zero.
 C_COEF_OVERFLOW (7): Overflow on C coefficients.
 C_COEF_OUT_OF_RANGE (8): One or more C coefficients values are out of range.
SOLUTION: **Field Service Technician:** Open Recognition Module. Check if flat cable is correctly connected. If not, **Power off**, insert correctly the flat cable then power on. Close Recognition Module.

BNR Advanced Troubleshooting

A proper knowledge of the BNR elements functions and sensors position is also required to carry out an effective troubleshooting

Let's see this through another example !

BNR diagnostics, troubleshooting and

Diagnostic - MEI BNR #350612001460

Diagnostic Overview Page

- ▶ User Information
- ▶ Customer Information
- ▼ Status Information

XFS Status

Device Status	DEVICE HARDWARE ERROR (6174)
Dispenser Status	DISPENSER CU STATE (6182)
Intermediate Stacker Status	INTERMEDIATE STACKER EMPTY (6185)
Safe Door Status	SAFE DOOR LOCKED (6196)
Shutter Status	SHUTTER CLOSED (6198)
Transport Status	TRANSPORT OK (6203)

System Status

operationalStatus	NOT OPERATIONAL (2) ❌
errorCode	NO ERROR (0)
billTransportStatus	OK (0)
billStorageStatus	WARNING (4) ⚠️
cashTypeStatus	OK (1)

positionStatuses

positionStatus 1	
shutterStatus	SHUTTER NOT SUPPORTED (6201)
contentStatus	EMPTY (0)
positionStatus 2	
shutterStatus	SHUTTER CLOSED (6198)
contentStatus	EMPTY (0)

▼ Application Components Overview

Package version:
In comparison to the package version 1.7.1 BNR firmware is up to date FALSE

CashC

Overview ❌ Main Module ❌ Bundler Module Spine Module Barcode Reader ⚠️ Loader-1 Recycler-3 Recycler-4 Recycler-5 Recycler-6 »

Faulty module...

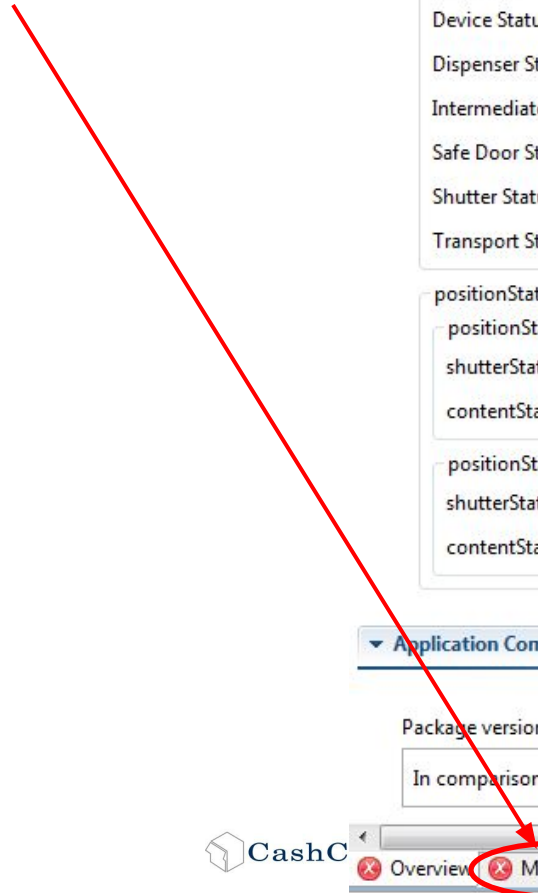

Diagnostic - MEI BNR #350612001460

Main Module Diagnostic Page This module is in error

Expand Collapse

General Information

Module ID	Main Module (917504)
Module Serial Number:	35061200146
Description:	MEI BNR Main Module
User Data:	

Module Status MAIN_MODULE

operationalStatus	NOT OPERATIONAL (2)
errorCode	NO ERROR (0)
billTransportStatus	OK (0)
billTransportSection	UNKNOWN (0)

Element Status (INLET_BILL_SENSOR)

Element Status (XCHANNEL_SENSOR)

Element Status (BILL_WIDTH_SENSOR)

Element Status (BILL_INTAKE_BILL_SENSOR)

Element Status (POSITIONER_BILL_SENSOR)

element ID	POSITIONER_BILL_SENSOR (196864)
operationalStatus	NOT OPERATIONAL (2)
errorCode	SIGNAL LOW (2)
functionalStatus	UNKNOWN (0)

Element Status (BOTTOM_TRANSPORT_BILL_SENSOR)

Element Status (OUTLET_BILL_SENSOR)

Element Status (BILL_INTAKE_COVER)

Overview Main Module Bundler Module Spine Module Barcode Reader Loader-1 Recycler-3 Recycler-4 Recycler-5 Recycler-6

...faulty element and error

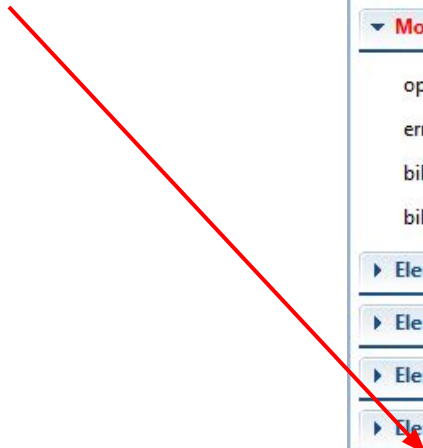

Now we take the sensors diagram and locate the element:

BNR4-21 (Work sheet)

Positioner Sensor

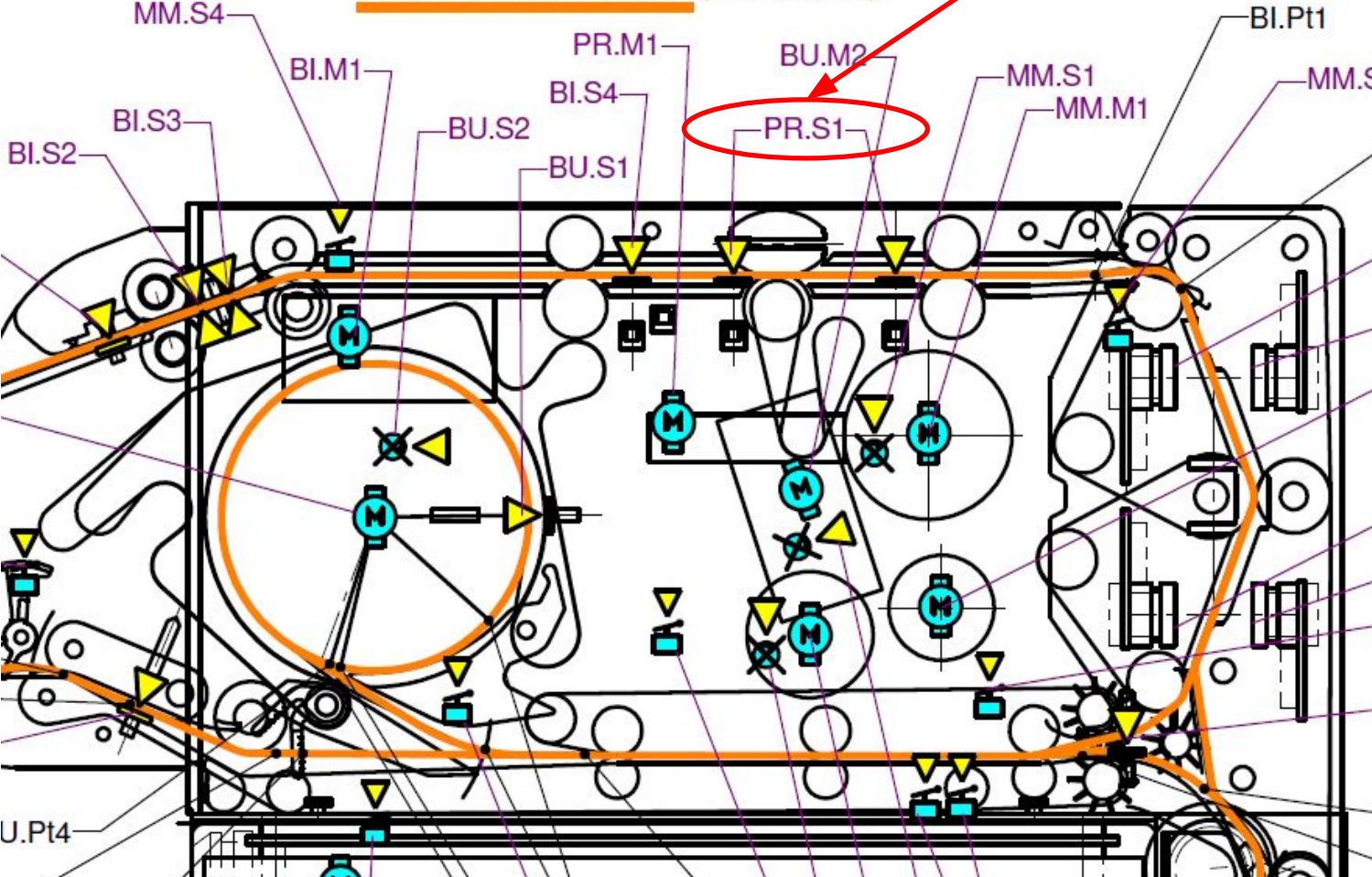

BNR diagnostic file log entries: records all bill events inside the BNR system (motors, sensors, etc.) useful to understand the reason of a problem.

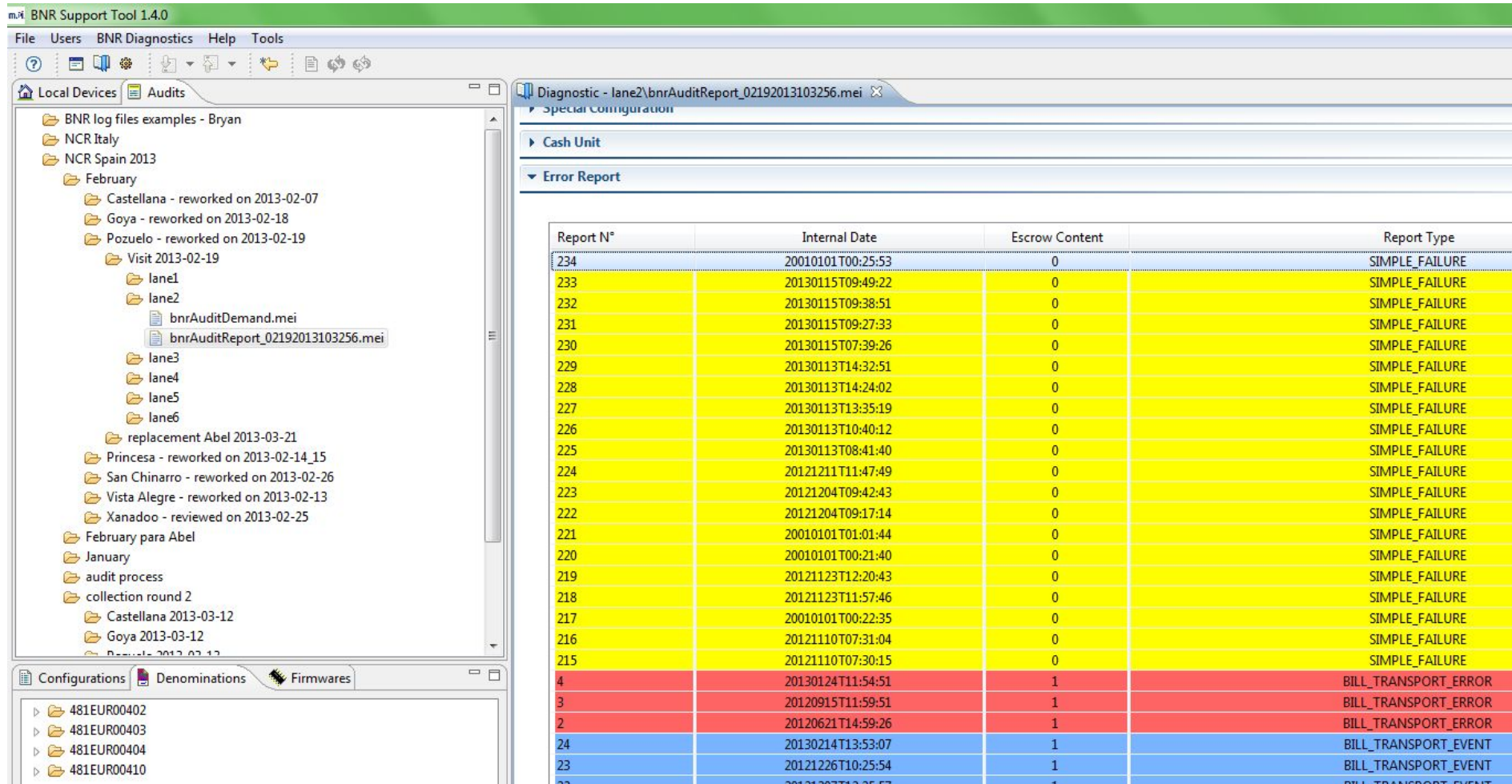

The screenshot shows the BNR Support Tool 1.4.0 interface. The left pane displays a file tree under 'Local Devices' > 'Audits', with 'bnrAuditReport_02192013103256.mei' selected. The right pane shows the 'Error Report' section of the diagnostic file, containing a table of log entries.

Report N°	Internal Date	Escrow Content	Report Type
234	20010101T00:25:53	0	SIMPLE_FAILURE
233	20130115T09:49:22	0	SIMPLE_FAILURE
232	20130115T09:38:51	0	SIMPLE_FAILURE
231	20130115T09:27:33	0	SIMPLE_FAILURE
230	20130115T07:39:26	0	SIMPLE_FAILURE
229	20130113T14:32:51	0	SIMPLE_FAILURE
228	20130113T14:24:02	0	SIMPLE_FAILURE
227	20130113T13:35:19	0	SIMPLE_FAILURE
226	20130113T10:40:12	0	SIMPLE_FAILURE
225	20130113T08:41:40	0	SIMPLE_FAILURE
224	20121211T11:47:49	0	SIMPLE_FAILURE
223	20121204T09:42:43	0	SIMPLE_FAILURE
222	20121204T09:17:14	0	SIMPLE_FAILURE
221	20010101T01:01:44	0	SIMPLE_FAILURE
220	20010101T00:21:40	0	SIMPLE_FAILURE
219	20121123T12:20:43	0	SIMPLE_FAILURE
218	20121123T11:57:46	0	SIMPLE_FAILURE
217	20010101T00:22:35	0	SIMPLE_FAILURE
216	20121110T07:31:04	0	SIMPLE_FAILURE
215	20121110T07:30:15	0	SIMPLE_FAILURE
4	20130124T11:54:51	1	BILL_TRANSPORT_ERROR
3	20120915T11:59:51	1	BILL_TRANSPORT_ERROR
2	20120621T14:59:26	1	BILL_TRANSPORT_ERROR
24	20130214T13:53:07	1	BILL_TRANSPORT_EVENT
23	20121226T10:25:54	1	BILL_TRANSPORT_EVENT
22	20121226T10:25:53	1	BILL_TRANSPORT_EVENT

BNR diagnostics, troubleshooting and error reporting

The “Fault code spreadsheet”

Maps the BNR ST error code into the proper SAP code.

Main Module			Loader		
Module	Fault Code	Error Description	Module	Fault Code	Error Description
Main Module	MM01	No Error	Loader	LO01	No_Error
Main Module	MM02	Incompatible_SW	Loader	LO02	Com_Breakdown
Main Module	MM03	Boot_Running	Loader	LO03	Incompatible_Module
Inlet Sensor	MM04	Signal_High	Loader	LO04	Missing_Module_Type
Inlet Sensor	MM05	Signal_Low	Loader	LO05	Wrong_Module_Type
X Channel Sensor	MM06	Signal_High	Loader	LO06	Boot_Running
X Channel Sensor	MM07	Signal_Low	Bill Sensor	LO07	Signal_High
Bill Width Sensor	MM08	Signal_High	Bill Sensor	LO08	Signal_Low
Bill Width Sensor	MM09	Signal_Low	Bill Sensor	LO09	Com_Breakdown
Bill Intake Bill Sensor	MM10	Signal_High	Transport Motor	LO10	Not Started
Bill Intake Bill Sensor	MM11	Signal_Low	Transport Motor	LO11	Com_Breakdown
Positioner Bill Sensor	MM12	Signal_High	Transport Motor	LO12	Speed_To_Low
Positioner Bill Sensor	MM13	Signal_Low	Pressure Plate	LO13	Com_Breakdown
Bottom Transport Bill Sensor	MM14	Signal_High	Pressure Plate	LO14	Plate_Blocked
Bottom Transport Bill Sensor	MM15	Signal_Low	Pressure Plate	LO15	Plate_To_Low
Outlet Bill Sensor	MM16	Signal_High	Anti Fishing Flap	LO16	Closed
Outlet Bill Sensor	MM17	Signal_Low	Anti Fishing Flap	LO17	No_Com
Main transport Motor	MM18	Speed_To_Low	Loader	LO18	Replaced_Spare_Part
Stacker	MM19	Cannot_Position			
Stacker	MM20	Hardware_Failure			
Stacker	MM21	Blocked_At_Home			
Stacker	MM22	Blocked_At_Bill_Path			
Stacker	MM23	Blocked_At_CB_Entry			
Stacker	MM24	Blocked_Around_Home			
Stacker	MM25	Stopped_At_Bill_path			
Stacker	MM26	Stopped_At_CB_Entry			
Stacker	MM27	Cannot_Move_To_TrashBin			
Stacker	MM28	Blocked_In_CB			
Stacker	MM29	Stopped_In_CB			

Spine		
Module	Fault Code	Error Description
Spine	SP01	No_Error
Spine	SP02	Com_Breakdown
Spine	SP03	Incompatible_Module
Spine	SP04	Missing_Module
Spine	SP05	Opened
Spine	SP06	Wrong_Module_Type
Spine	SP07	Boot_Running
Spine Bill Sensor	SP08	Signal_High



SAP code

Troubleshooting practical exercise !

BNR testing

- Tests and checks on the BNR:

Makes sense to perform checks on the unit both before we operate on it for repair, and after. Purpose at preliminary stage is get a picture of the overall situation (and possible faults) on the unit. Then, after the repair actions on it, make sure the unit is fully functioning.

- “Pre-repair”, to be carried out on a unit incoming for service/repair. Purpose is identify possible issues/weaknesses beyond the ones that have been possibly raised by the customer. This can be done going through an “inspection check-list”.
 → **BNR Repair Guide**
- “After-repair”, quite obviously, this is aimed to verify that the service/repair operations have been successful, unit is fully functioning and ready to return to the field.
 → **BNR Bulletin (still unofficial)**
 → **BNR Repair Guide**

- Pre-repair: ins...
- After-repair: bu...

6.
The pur
units are
be add

+

COMPO
Interlo Assem
Shockbl Level
Modul
Spin
Revisi
Recogn Sens Ribbo Cabl

Loader:

	Description	Operation
1	Notes Dispense	100 billets dispensed from the loader to the outlet in bundles (6x 15 and 1x 10).
2	Noise	Make sure the loader makes no unusual noise while loading the notes.
3	Diagnostics	Save diagnostics file.

Recyclers:

	Description	Operation
1	Control of the drum capacity: <ul style="list-style-type: none"> • RE30 28/30 min • RE60 58/60 min 	<ul style="list-style-type: none"> • If variant is USD load the notes in the loader and dispense to the recycler. • If another variant is used insert the notes in the MM inlet. • Check RE30 and RE60 counters.
2	Empty Recyclers	Run empty recyclers to CB macro.
3	Park recyclers	Launch the PARK command to secure the RE tape for transport.
4	Diagnostics	Save diagnostics file.

Spine:

	Description	Operation
--	-------------	-----------



BNR servicing and maintenance

- Recommended **preventive maintenance intervals** are specified in the BNR Service Manual. Actions to be carried out either in the field (OEM technicians), either at A

BNR maintenance: Indoor environment

- Specific cleaning instructions, only...) are also provided in th

- More in depth operations – sp knowledge and high expertise the Repair Workshop !

Frequency	50k unit cycles, cleaning	20k loader cycles, cleaning	250k unit cycles	500k unit cycles , Overhaul
Type	cleaning	cleaning	Overhaul	Overhaul
Location	Field	Field	Service Center	Service Center
Module				
Main Module	Air jet ²		Clean BU roller & belt (Only up to MM12 version)	Clean BU roller & belt * Clean all tires , rollers & belts Clean all light pipes (air)
Cash Box	Air jet		-	-
Loader	Air jet	Air jet Cleaning with IPA ³	-	Clean all light pipes (air)
Recycler	Air jet		Clean RE roller & tape (Only up to RE10 version)	Clean RE tape & roller Clean all light pipes (air)
Spine	Air jet		-	Clean belts & rollers Clean all light pipes (air)
Chassis (Interlock)	Air jet		-	Clean all light pipes (air)

BNR Service Manual

BNR jams clearing (hints)

- This topic is not specifically of ASCs interest. For more info about this subject:

-“Easy“ jam clearing

  **BNR User Manual**

-“Advanced” jam clearing

  **BNR Service Manual**

BNR repair workshop



BNR Repair: Training sub-units

Training sub-unit	BNR Module	Module element	Type of operations	Level	Resources	Link to available resources
MM-1	Main Module	Positioner	Remove-refit/replace	ASC	Official Repair Videos	Removing Positioner WEB.mp4 Reinstalling Positioner WEB.m4v
MM-2	Main Module	Positioner O-ring	Remove-refit/replace	ASC	Unofficial video	Replacing the O ring of the positioner V2012.10.2
MM-3	Main Module	Bezel Assy	Remove-refit/replace	ASC	Official Repair Videos	Replacing Bezel Assembly WEB.m4v
MM-4	Main Module	Outlet Flap	Remove-refit/replace	ASC	Official Repair Videos	Replacing outlet flap WEB.m4v
MM-5	Main Module	Inlet sensors	Cleaning	ASC	-	-
MM-6	Main Module	Piston	Remove-refit	ASC	Official Repair Videos	Removing Piston WEB.m4v Reinstalling Piston WEB.m4v
MM-7	Main Module	Cables	Remove-refit/replace	ASC	Official Repair Videos	Replacing Cable WEB.m4v
MM-8	Main Module	Up/Down sensor	Remove-refit/replace	ASC	Official Repair Videos	Replacing Up-sensor WEB.m4v Replacing Down-sensor WEB.m4v
MM-9	Main Module	RS Rear Guide	Remove-refit/replace	OEM (?)	Unofficial video, Bulletin	How to replace the HI Roller guide rev 01.mpg FG00711 RearGuide Bulletin.pdf
MM-10	Main Module	Bundler	Calculate slippage of the bundler	ASC	Excel macro, Draft doc by JamesC	Calcul glissement Bundler.xlsx Draft - Nettoyage Bundler - BU Cannot find mark -
MM-11	Main Module	Bundler	Cleaning	ASC	Unofficial video	BNR CLEANING BUNDLER 2011.04.19 V01.mpg

■ Repair workshop part 1: Modules disassembly

- Main Module:
 - Positioner, Positioner O-ring
 - Piston
 - Bezel, inlet, outlet
 - Up sensor, down sensor
 - RS rear guide
- Loader:
 - Full module disassembly
- Chassis:
 - Interlock and bar
- Spine:
 - Gear wheel and Spine door

  **BNR ASC official videos**

- Repair workshop part 2: other service procedures
 - Rotating diverter adjustment
 - Bundler: slippage calculation, cleaning, coding wheel replacement
 - BNR calibration
 - Sensor board replacement
 - Cashbox
 - Loader: cleaning
 - Recycler: tape adjustment, cleaning, green roller

BNR spare parts

- CPI always keeps ASCs updated in the Spare Parts Catalogue. Current
- The catalogue has consistently been continuously adding new parts for a given part, not yet available. Please contact your request to CPI Tech Support.
- **RETAIN THE PARTS !** In order to ensure the product and spot possible wear, please retain the replaced/broken parts. Until new indications will be provided, please retain like ASCs to follow.

MAIN MODULE			Price-list
Part Number	Designation	Additional Description	EUR
66808001P1	ST-piston assy spare		100.00
			

MAIN MODULE			Price-list
Part Number	Designation	Additional Description	EUR
665934001P1	PH-Positioner assy spare		301.00
			

MAIN MODULE			Price-list
Part Number	Designation	Additional Description	EUR
668006203P100	S BNR_PAN HEAD SCR TORX M4X5.PK100		11.50
			pack 100
			

MAIN MODULE			Price-list
Part Number	Designation	Additional Description	EUR
676691001P100	S BNR_RNUNHELD HEAD SCREW M3X6.PK100		76.50
			pack 100
			

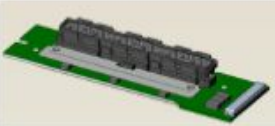
MAIN MODULE			Price-list
Part Number	Designation	Additional Description	EUR
675707001P1	RS-Up-B-sensor-assy spare		151.00
			

CPI service management



BNR Web site, FTP site and CPI periodic communications



■ The MEI BNR website

- Videos that illustrate the BNR principles and advantages
- ROI calculator to estimate the savings that BNR allows
- F.A.Q. section (“ask the experts”)
- More...

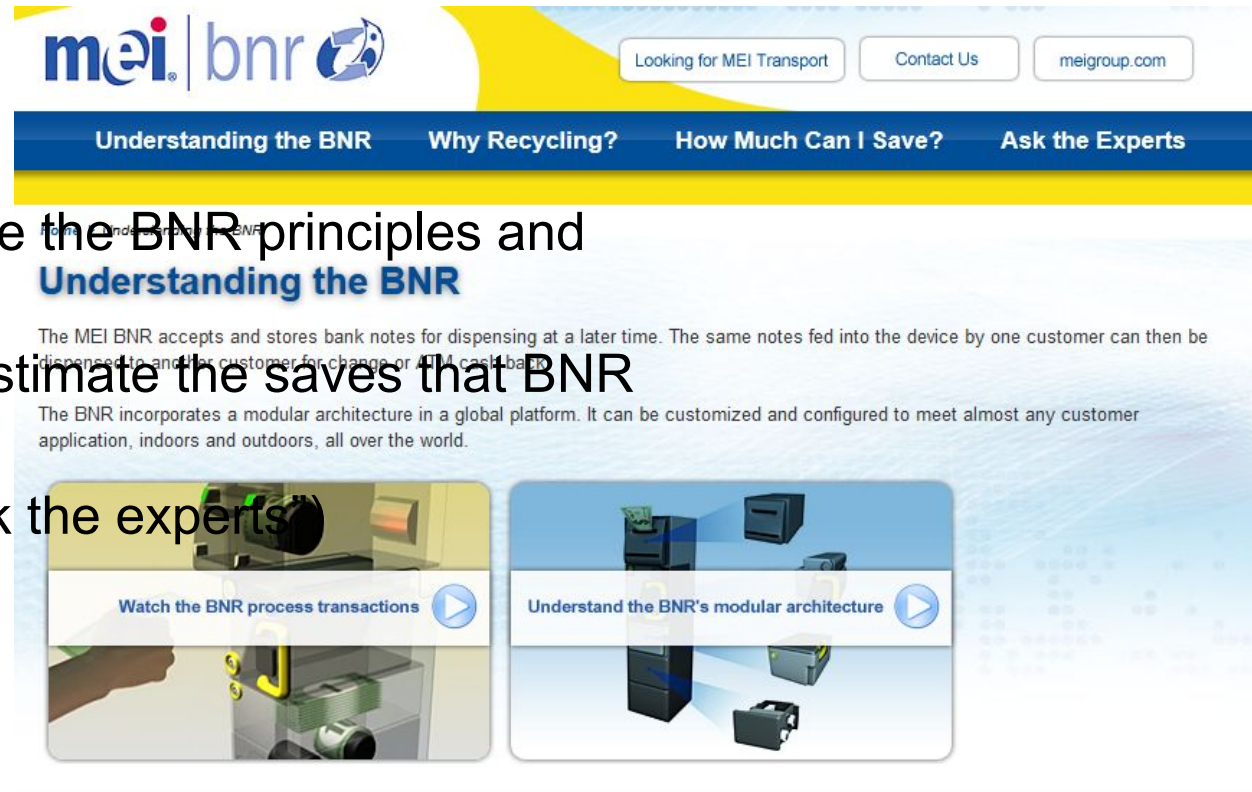

The screenshot shows the MEI BNR website homepage. At the top, there is a navigation bar with the MEI BNR logo and three buttons: "Looking for MEI Transport", "Contact Us", and "meigroup.com". Below this is a blue navigation menu with the following items: "Understanding the BNR", "Why Recycling?", "How Much Can I Save?", and "Ask the Experts". The main content area features a section titled "Understanding the BNR" with a sub-header "From Understanding the BNR". The text describes the BNR as a device that accepts and stores bank notes for dispensing at a later time, and mentions a modular architecture. Two video thumbnails are visible: "Watch the BNR process transactions" and "Understand the BNR's modular architecture".

- Guides and Bulletins Outlined in this Presentation
- MEI Gaming / Retail Tech Support Website
- BNR Applications Engineers
 - Luis Fuller (luis.fuller@cranePi.com)
 - Fabio Materia (fabio.materia@cranePi.com)
 - Pat Erbe (pat.erbe@cranePi.com)
 - Shane Timmons (shane.timmons@cranePi.com)
 - Abdel Latoui (abdel.latoui@cranePi.com)