

Training Manual

For LED TV ES7000

Series UE40ES7000

UE46ES7000

UE55ES7000

UE40ES7500(CIS

)

UE46ES7500(CIS

)

UE55ES7500(CIS

)



index

- I. Product Concept
- II. UES7000 Overview
- III. Inside of UES7000
- IV. Main board
- V. New Function of UES7000
- VI. Disassembly and Reassembly
- VII. Change IR
- VIII. Cables
- IX. Troubleshooting

Product Concept

SAMSUNG

I. Product Concept

"Voice/Gesture Control, Face Recognition SI, New Experience NEW Smart TV" (ES7000)

- SI (Smart Interactive) : Quick approach to menu and service by voice control. Direct navigation by Gesture control

"New Experience(SI), '12 TV New Design Trend's New Concept Premium Design, and Support world best picture quality. High-end Smart TV" (ES8000)

- Design : Flower Petal look Metallic Design (Detailed Premium design)
Curved line Stand: '12 New Trend of TV Design
- Picture Quality (Micro Dimming Ultimate) : By 576 block's detailed picture control, Support world best clear quality

■ External Value Curve

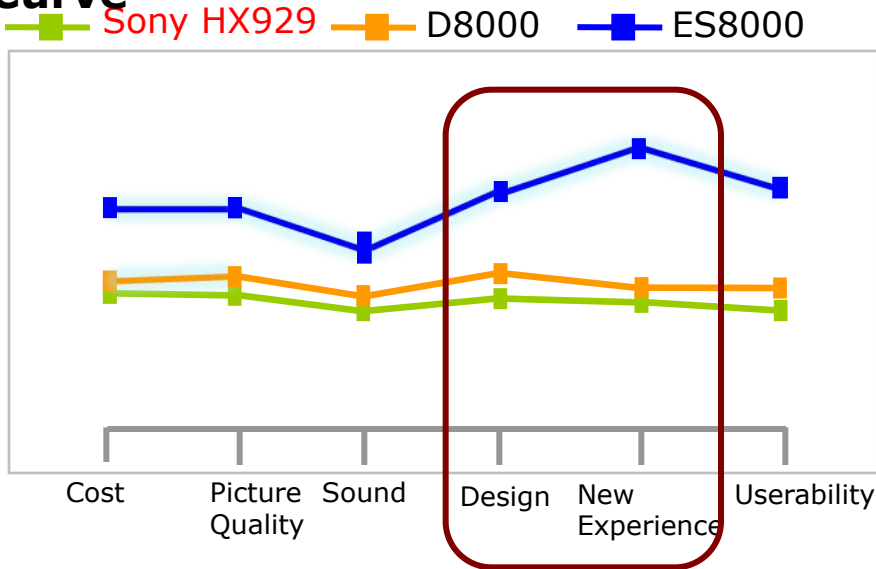

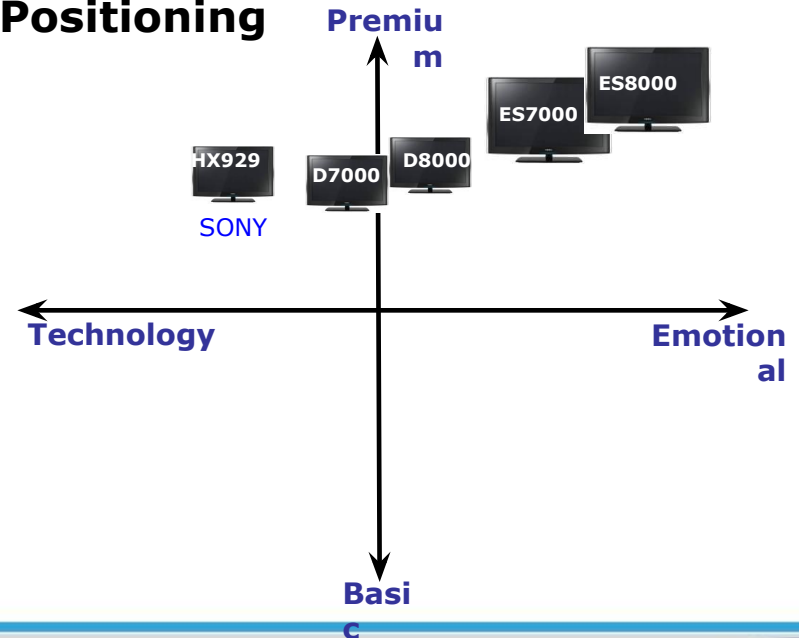

■ Strategic Positioning



UES7000 Overview

SAMSUNG

Spec Comparison to the Old Models

Model	UES7000	UD7000
Design		
Display Type	LED TV	LED TV
Built-in Tuner	O	O
Resolution	1920 x 1080	1920 x 1080
LCD Panel	TFT LCD Panel 240Hz	TFT LCD Panel 240Hz
Screen Size	40"/46"/55"	40"/46"/55"
Picture ratio	16:9	16:9
Dimensions(W x H x D)	914.4 * 611.2 * 241.3 mm with stand 914.4 * 545.7 * 29.7 mm without stand 46": 1046.8*691.2*276.7 mm with stand 1046.8*620.2*29.7 mm without stand 55": 1238.4*790.4*276.7 mm with stand 1238.4*728*29.7 mm without stand	40": 908.6 X 29.7 X 524.9 mm with stand 908.6 X 241.3 X 600 mm without stand 46": 1041.1 X 29.7 X 599.4 mm with stand 1041.1 X 276.5 X 607.5 mm without stand 55": 1232.6 X 29.7 X 707.2 mm with stand 1232.6 X 309.3 X 789.7 mm without stand
Weight	40" : 9.55kg_without stand 11.8kg_with stand 46" : 11.98kg_without stand 14.6kg_with stand 55" : 16.6kg_without stand 19.3kg_with stand	40" : 10.0kg_without stand 12.0kg_with stand 46" : 12.4kg_without stand 14.3kg_with stand 55" : 16.2kg_without stand 18.6kg_with stand
Contrast Ratio	MEGA CR	MEGA CR
Picture Enhancer	3D HyperReal Engine	3D HyperReal Engine
Equalizer	5 Band	5 Band
Auto Volume Control	O	O
Surround Sound	Dolby Digital Plus / Dolby Pulse, DNSe	Dolby Digital Plus/Pulse
Speaker Output	10W + 10W	40"/ 46": 10W + 10W 55"/65" : 15W +15W
PIP	O	O
Double Window	X	X
Caption	O	O
Entertainment Mode	X	X
Game Mode	O	O
Energy Saving	O	O
Anynet+	O	O
Antenna	1(Cable/Air/Satellite)	1(Cable/Air/Satellite)

UES7000 Key parts

- 1080P FULL HD
- 3HDMI, HDMI CEC support
- 240Hz Auto Motion Plus
- All Share Play
- Smart Hub (Full browser, Media play)
- Built-in Wifi
- Motion Control & Voice Control
- Built-in Camera
- 3D
- Smart Control
- IR Blaster



UES7000

- Vesel: Super Narrow Bezel (Factory Option: U-MOIP-7K)
- Panel: 40", 46", 55", Super Clear
- memory: 2G
- power consumption: 40": 135W / 46": 150W / 55": 160W / Standby <0.1W

Control & Connection Panel

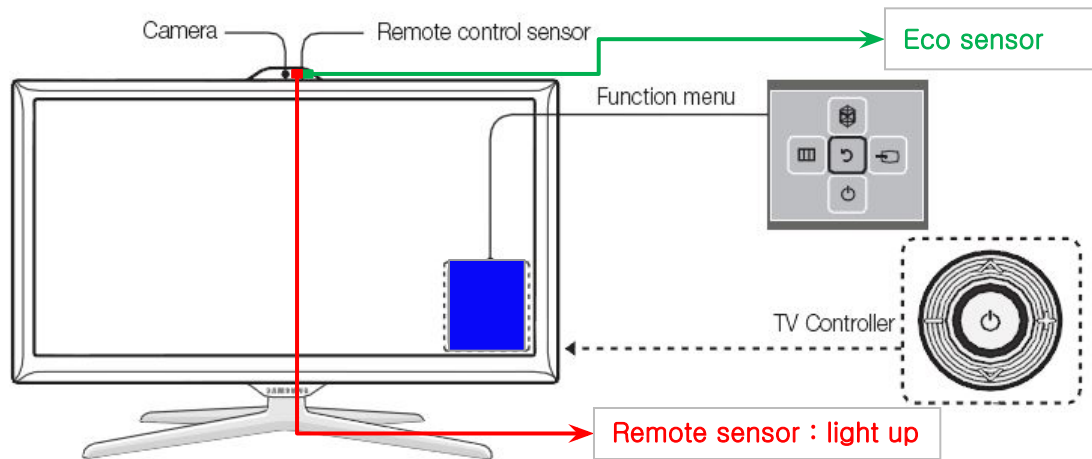

Follow these instructions facing the front of your TV.

Power on	Turn the TV on by pressing the Controller when the TV is in standby mode.
Adjusting the volume	Adjust the volume by moving the Controller from side to side when the power is on.
Selecting a channel	Select a channel by moving the Controller upwards and downwards when the power is on.
Using the Function menu	To view and use the Function menu, press and release the Controller when the power is on. To close the Function menu, press and release the Controller again.
Selecting the MENU (≡)	With the Function menu visible, select the MENU (≡) by moving the Controller to the left. The OSD (On Screen Display) Menu appears. Select an option by moving the Controller to the right. Move the Controller to the right or left, or backwards and forwards to make additional selections. To change a parameter, select the it, and then press the Controller.
Selecting the SMART HUB (⊕)	With the Function menu visible, select SMART HUB (⊕) by moving the Controller upwards. The SMART HUB main screen appears. Select an application by moving the Controller, and then pressing the Controller.
Selecting a Source (⊖)	With the Function menu visible, open the Source (⊖) by moving the Controller to the right. The Source screen appears. To select a Source , move the Controller back and forth. When the source you want is highlighted, press the Controller.
Power Off (⏻)	With the Function menu visible, select Power Off (⏻) by moving the Controller downwards, and then press the Controller.

Remote controller

Smart Touch Control

For more detailed information about Smart Touch Control, see "Using the Smart Touch Control" in e-Manual.

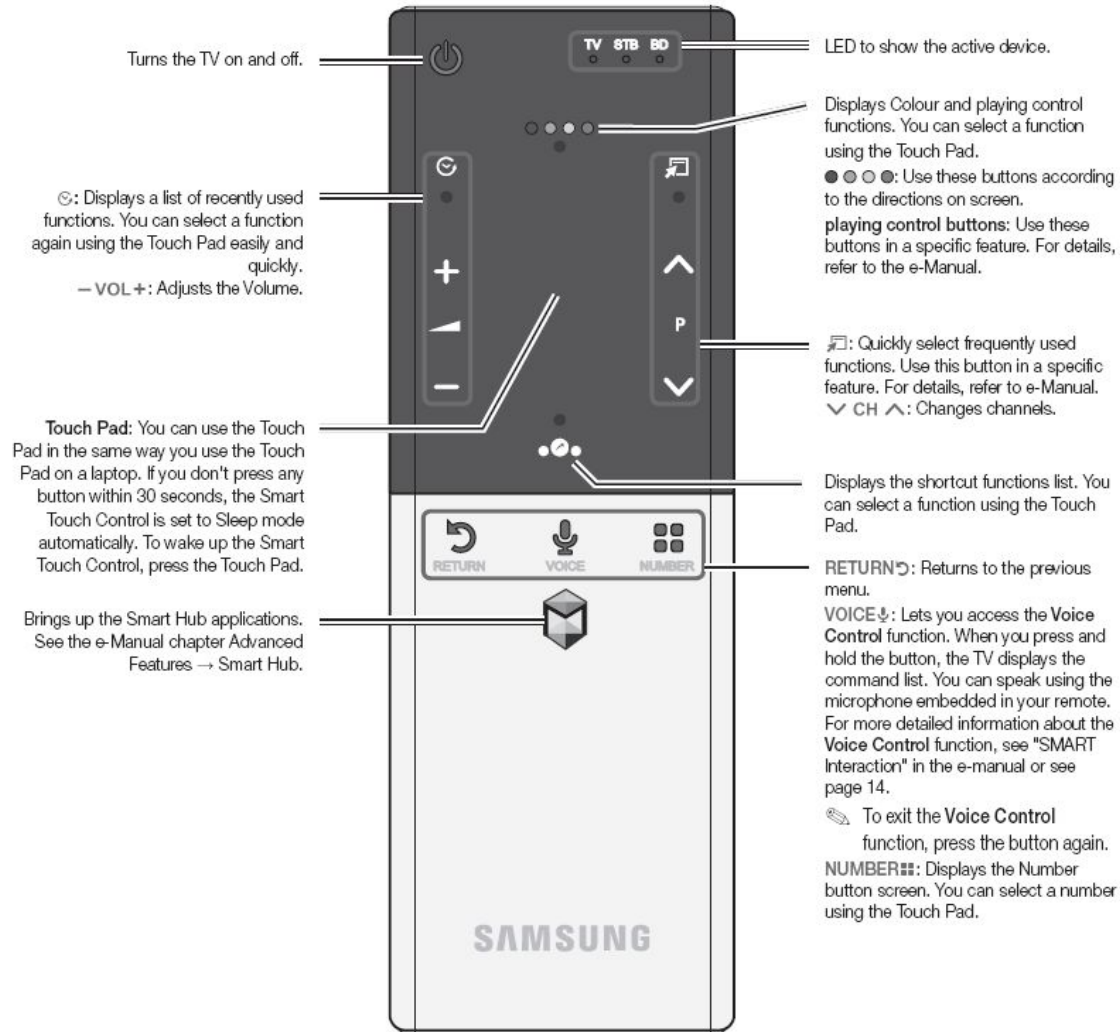

Remote controller

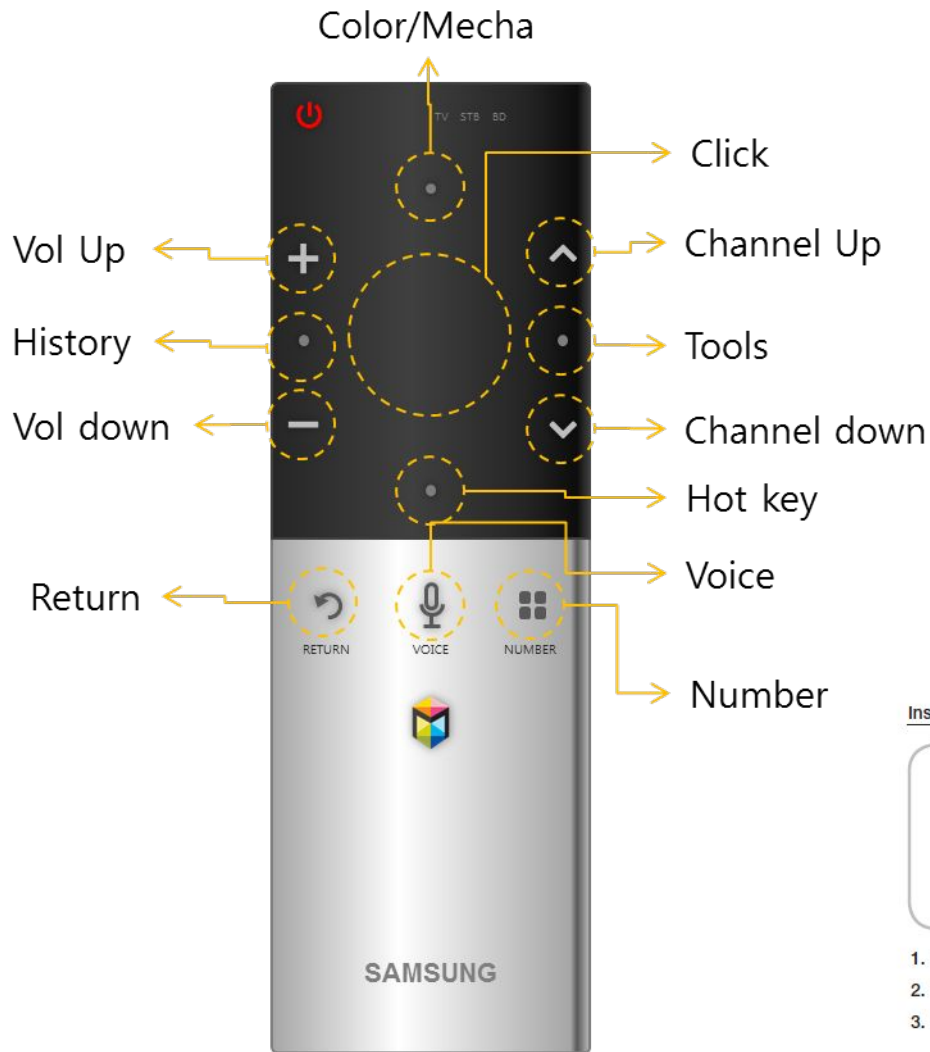

Inserting the Battery

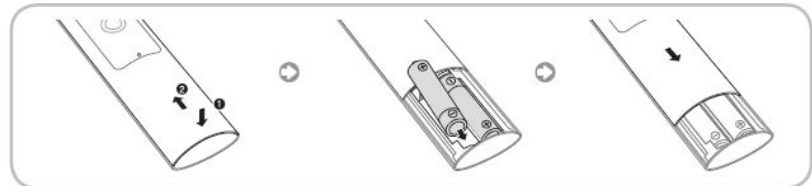

1. Slide and open the battery cover in the direction of the arrow.
2. Insert the 2 AA batteries in the tray.
3. Slide and close the back cover in the direction of the arrow.

Remote controller

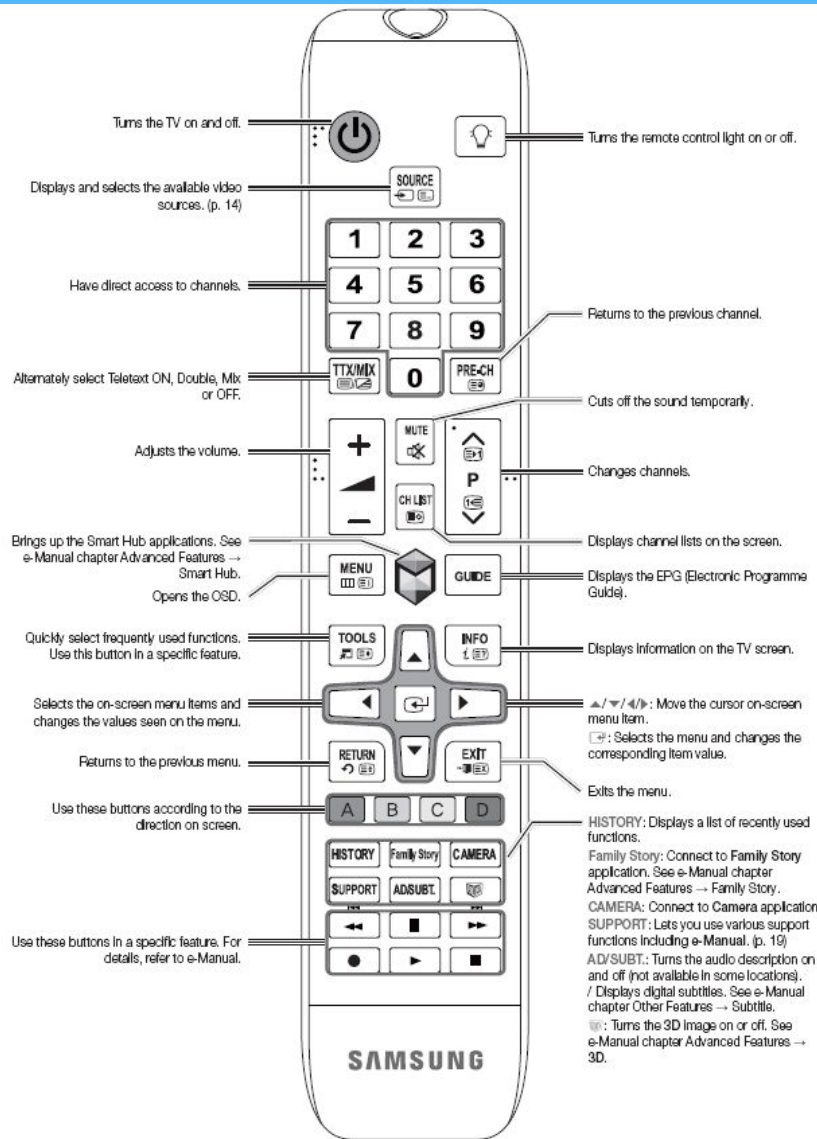

Accessories

- ✎ Please make sure the following items are included with your TV. If any items are missing, contact your dealer.
- ✎ The items' colours and shapes may vary depending on the models.
- ✎ Cables not included in the package contents can be purchased separately.
- ✎ Check that there is no accessory hidden behind packing materials when you open the box.

⚠ CAUTION: INSERT SECURELY LEST SHOULD BE DETACHED IN SET

- Smart Touch Control & Batteries (AA x 6)
- Remote Control & Batteries (AAA x 2)
- Owner's Instructions
- IR Blaster
- Power Cord
- Cleaning-Cloth
- Samsung 3D Active Glasses



Scart Adapter



Holder-Wire stand



Holder Ring x 4



CI Card Adapter

Accessories

IR Blaster



Inserting the Battery

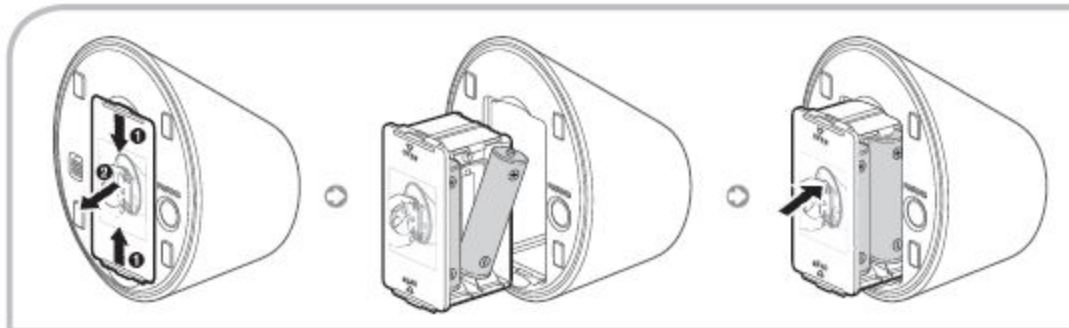

1. Hold the both sides of the battery holder and pull it out.
2. Insert the 4 AA into the battery compartment.
3. Push it back.

Accessories

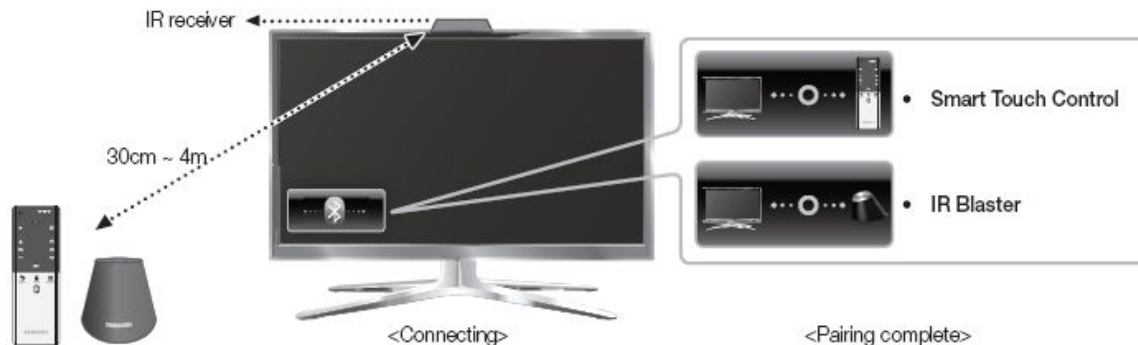

Initial Pairing

When you connect an IR Blaster with your TV, you can control connected external devices with your TV using the Smart Touch Control.



Smart Touch Control

After you have run the Initial Setup on your TV, you should connect your Smart Touch Control to your TV.

1. Turn the TV on by pressing the  button on.
 2. The connection icons appear on the bottom left of the screen, and the TV connects to your Smart Touch Control automatically.
-  If you want to perform the pairing process again, press the reset button in the center of the back cover using a pin or the tip of an unbent paper clip. The Smart Touch Control will be initialized.



IR Blaster

1. Turn on the IR Blaster. When Indicator LED blinks, you should connect IR Blaster to TV.
 2. Press the pairing button once shortly.
 3. The connection icons appear on the bottom left of the screen, and the TV connects to IR Blaster and Smart Touch Control automatically.
-  If the connection process failed, please turn off and on the IR Blaster, try again from step2.

Inside of UES7000

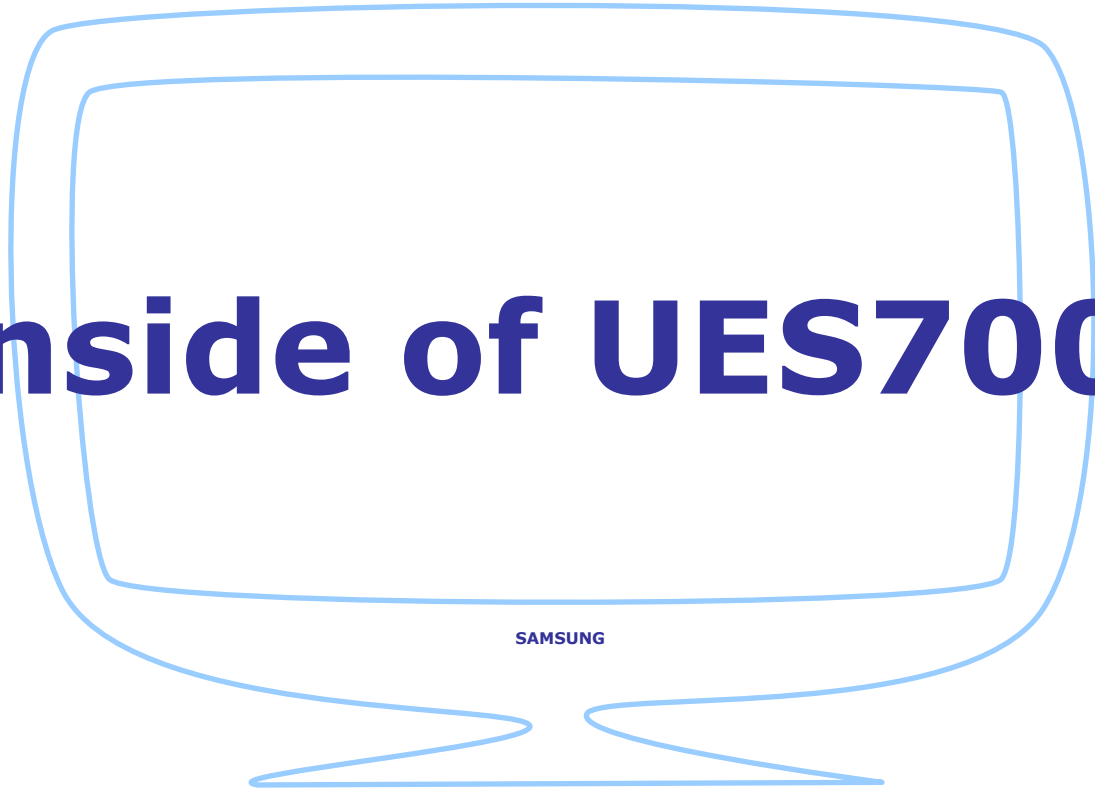

Inner Feature of UE8Y

IP board, Main board, Panel

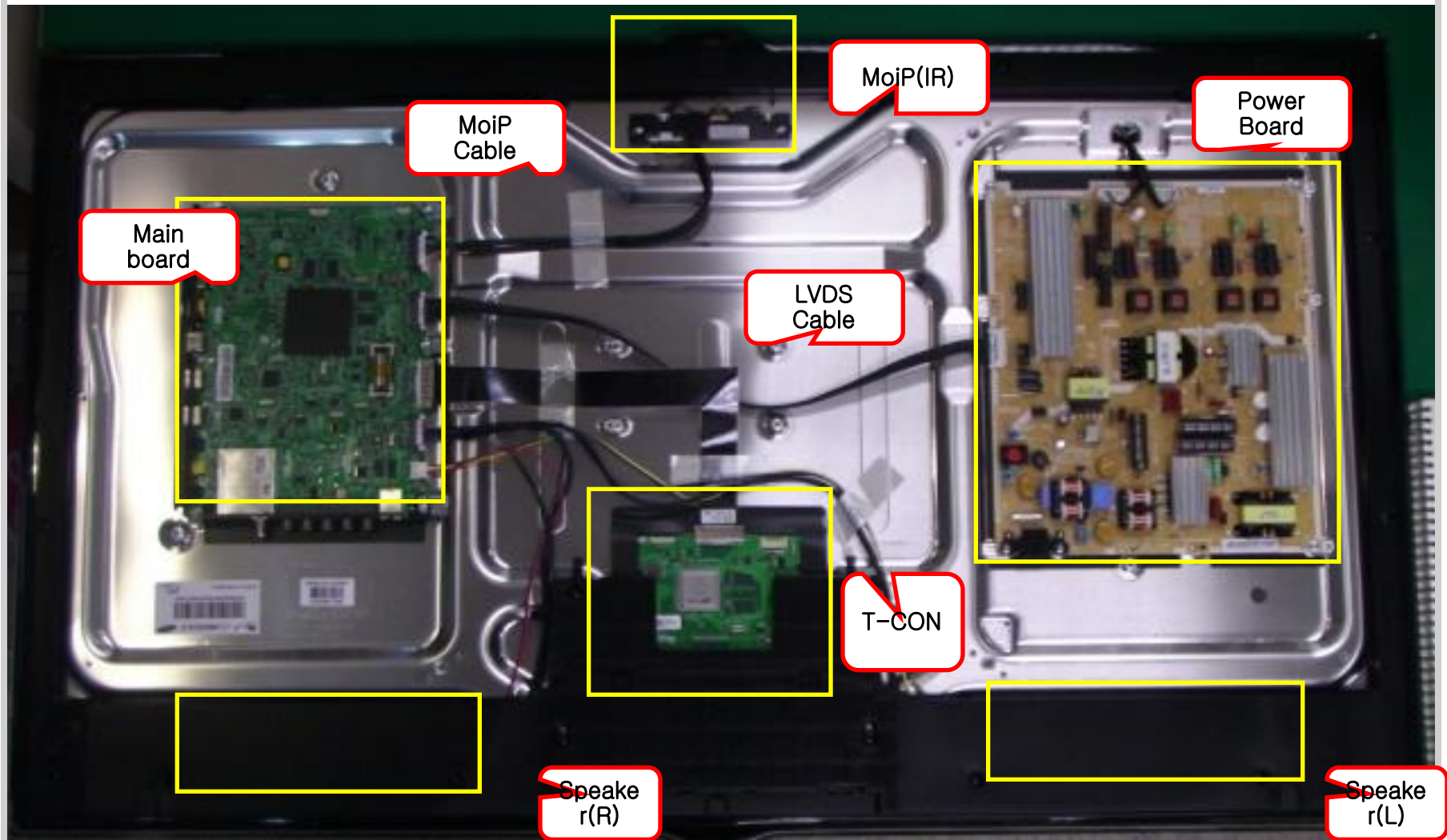

Wiring Diagram of UE8Y

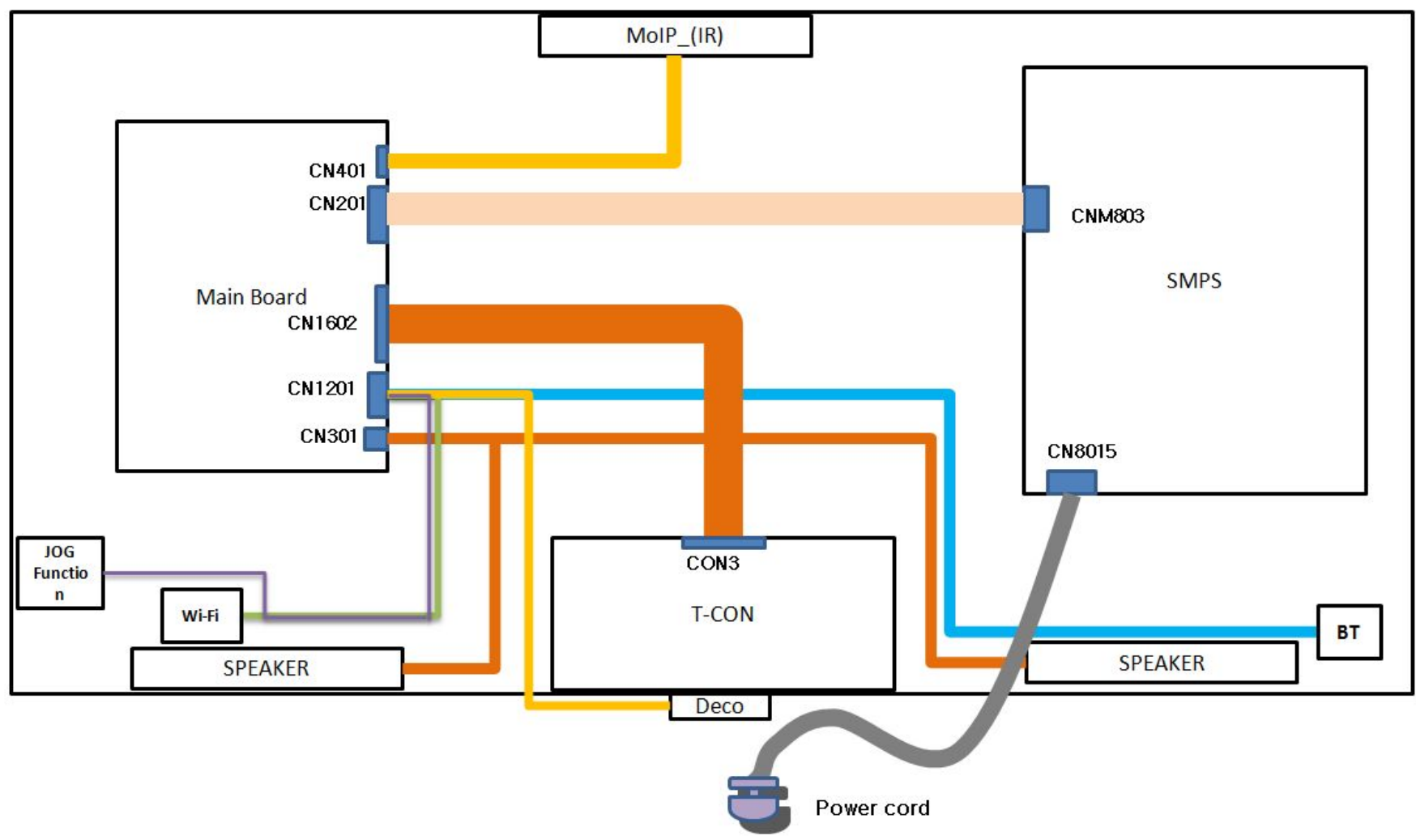

Main Board

SAMSUNG

Explanation of Main board

Main board LAYOUT

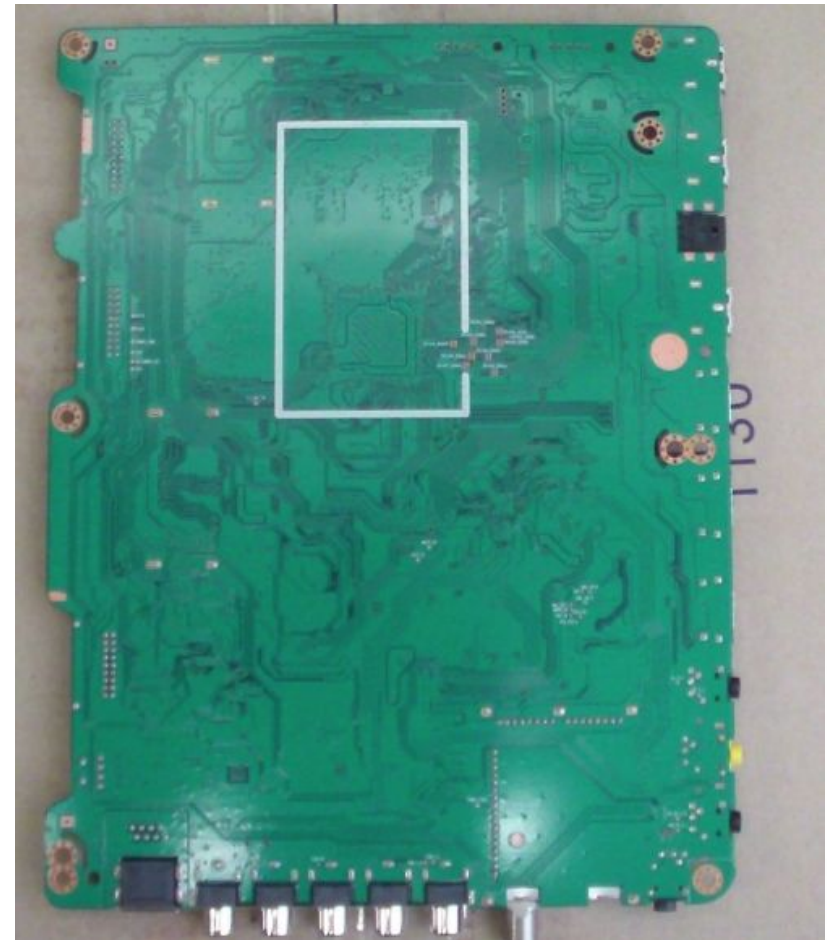
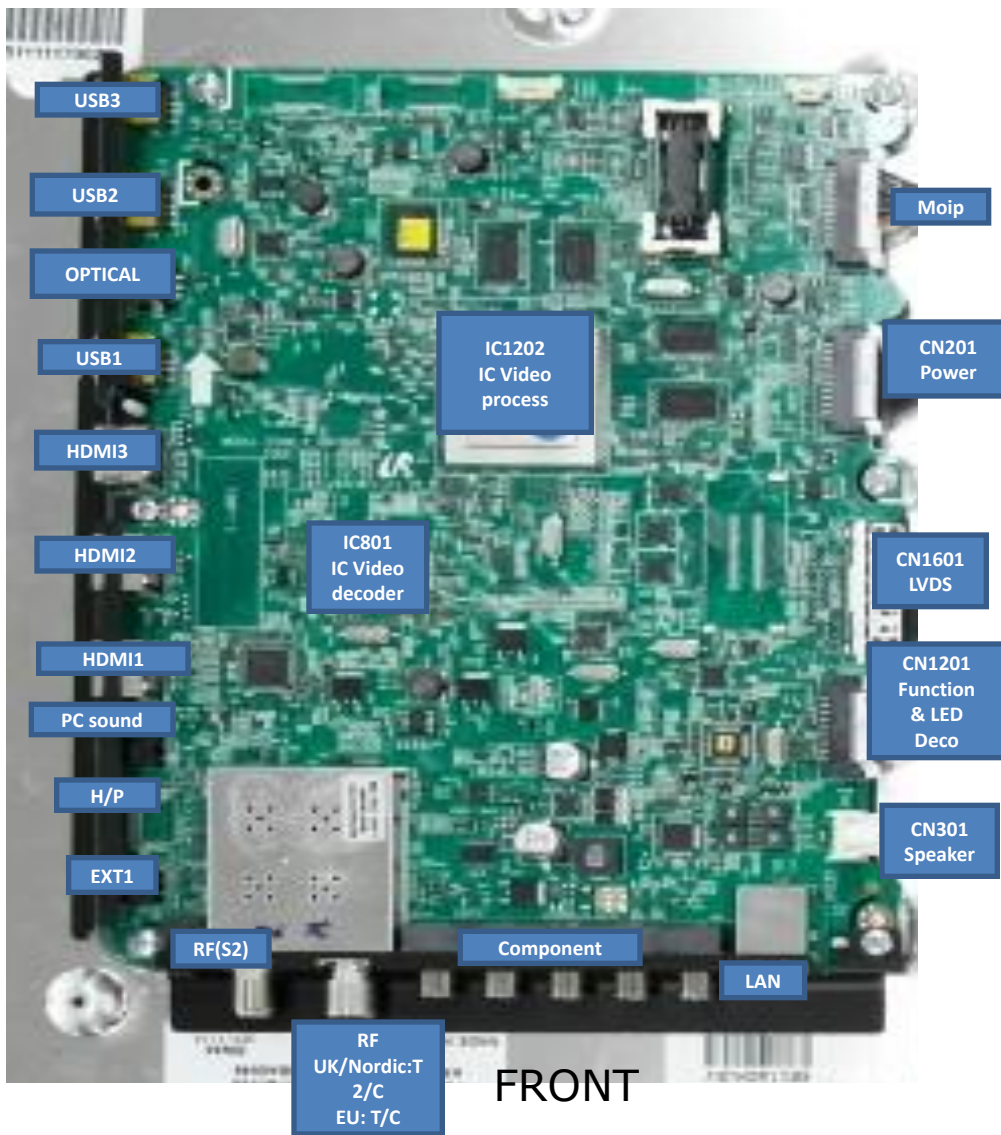

Explanation of Main board

ECHO-P/ECHO-A Block Diagram

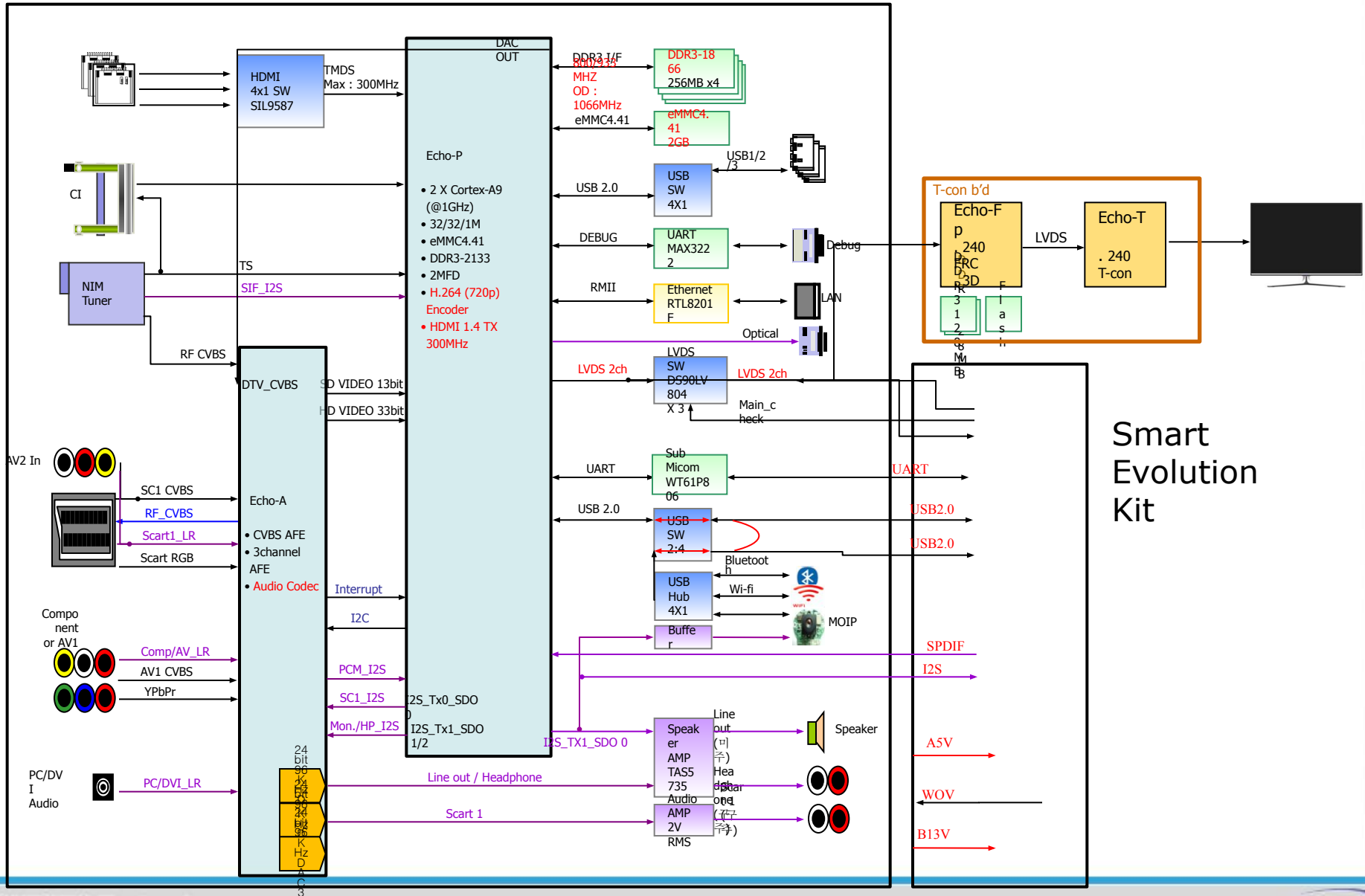

New Function of UES7000

SAMSUNG

Motion Control



1. Shake your hand in front of TV



2. Indicate a menu about CH, VOL in Screen



3. Move a cursor by using hand gesture, move a cursor to Channel up area



4. Grabbing hand is a Click.
(If you maintain hand grabbed, TV execute channel up consecutively)



5. If your hand let down on the screen, the menu will be a close

New Function of UE8Y

Voice Control



1. Show a Voice cognition Menu by command "Hi TV"

Chanel up



2. Control CH by command "Channel up/down"

Volume down



3. Control Volume by command "Volume up/down"

New Function of UE8Y*

Limitation of Voice control and Gesture Control

Item	Category	Environment	Condition	Check List	Spec	
1	Voice 	Wake On Voice	Noise	~ 40dB	Distance	1M ~ 4M
			Environment(RT(60))	~ 0.5 sec		
			User Volume	60 dB ↑	Angle	±30°
			TV Volume(dB)	0 step		
			Language	26 Language	Re-Test	2 ↓
			Speed	1sec ↓		
		Performance(%)	90%	Recognition word	HI TV, Smart TV	
		Magic Word	Noise	~ 40dB	Distance	1M ~ 4M
			Environment(RT(60))	~ 0.5 sec		
			User Volume	60 dB ↑	Angle	±30°
			TV Volume(dB)	0 step		
			Language	26 Language	Re-Test	2 ↓
			Speed	1sec ↓		
		Performance(%)	90%	Recognition word	HI TV, Smart TV	
		Imbeded Voice Control	Noise	~ 40dB	Distance	1M ~ 4M
			Environment(RT(60))	~ 0.5 sec		
			User Volume	60 dB ↑	Angle	±30°
			TV Volume(dB)	0 step		
Language	26 Language		Re-Test	25 ↓		
Speed	1sec ↓					
Performance(%)	90%	Recognition word	Korean/ English			
2	Hand Gesture 	Condition	Skin Color	White,Yellow,Black,Indian, Hispanic	Distance	1.5M ~ 4M
			Environment [Light]	50Lux ~ 500Lux	Horizontal Angle	±15°
			Background	White or Grey	Vertical Angle	±10°
			Speed	1sec ↓		
			Performance(%)	90%	Recognition	One hand

Smart Control



New Function of UE8Y

IR Bluster

- 1 Push SMART touch control Key
- Key Data sending to TV (Bluetooth)
- 2 TV □ IR Bluster, Key Data Transfer
- Bluetooth
- 3 External Device control
- IR Bluster □ Device, IR commend Send

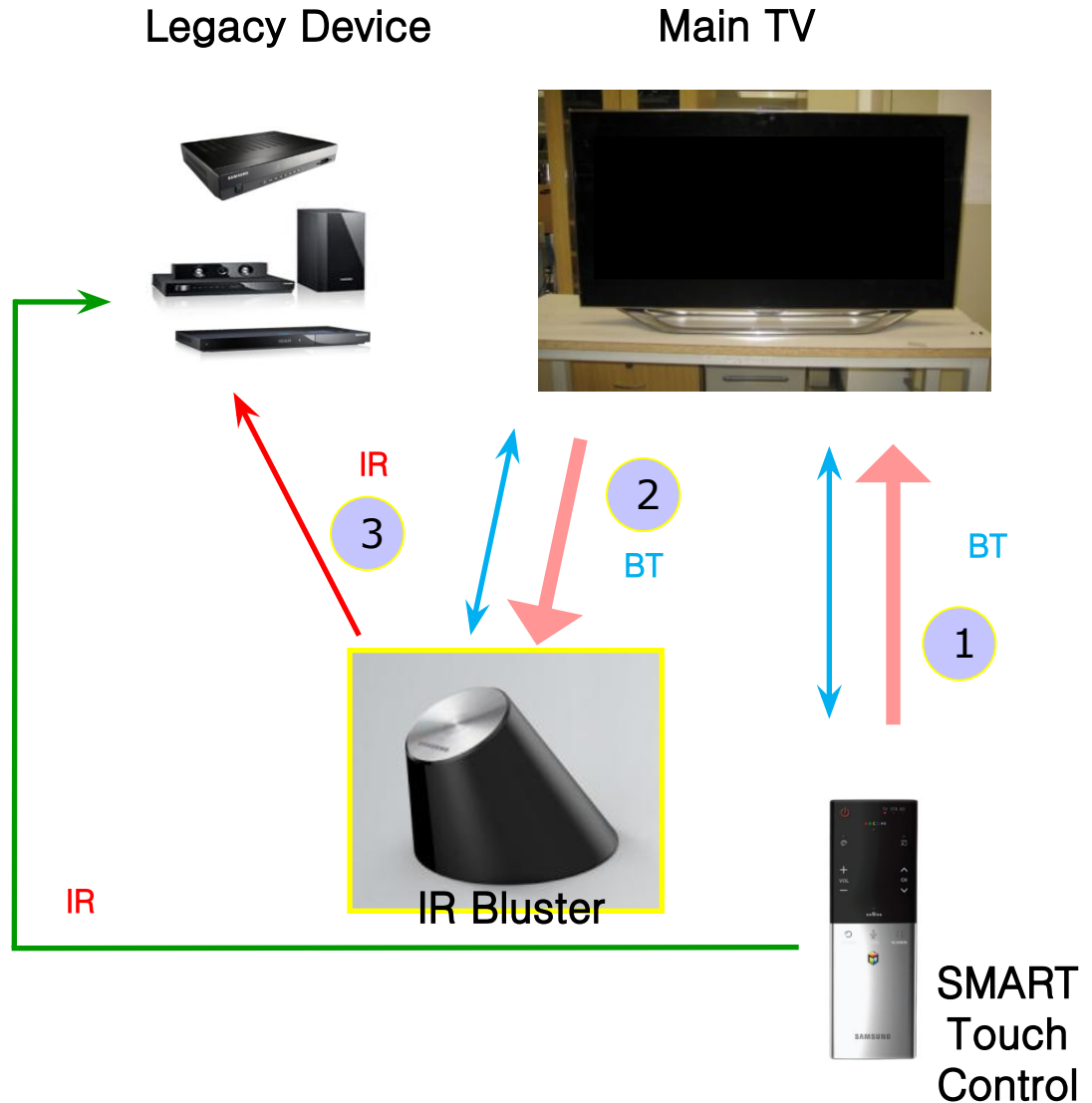

New Function of UE8Y

HID Connection



Wired or wireless connection



Sold Separately,
Support models are below.

Item	Maker	Model No
Keyboard+Mouse	Samsung	SRP-9100B
Keyboard		SRK-5000UB
Keyboard+Mouse	Logitech	MK550
		MK520
		MK320
		MK260
Keyboard	Logitech	K750
		K400
		K360
		K350
		K340
		K320
Mouse	Samsung	SMO-3500B
		SMO-3200B
Mouse	Logitech	V220
		M510
		M505
		M325
		M310
		M305
		M235
		M215
		M185
Mouse	Microsoft	Wireless Mobile Mouse 6000
		Wireless Mouse 5000
		Wireless Mobile Mouse 4000
		Wireless Mobile Mouse 3500
		Wireless Mobile Mouse 3000
		Wireless Mouse 1000
		Explorer Mini Mouse
Arc Mouse		

New Function of UE8Y

AllShare Play

→ AllShare Play



AllShare Play lets you access, view, or play photos, videos, or music located on USB devices, digital cameras, cell phones, and PCs. PCs, cell phones, and other compatible devices can be accessed wirelessly, through your wireless network. (Enjoy photos, music and/or movie files saved on a USB Mass Storage Class (MSC) device and/or your PC.)

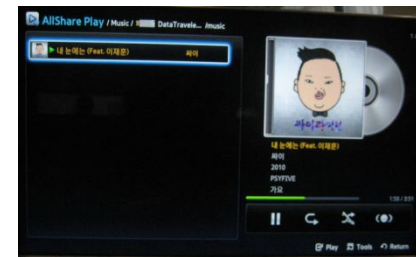
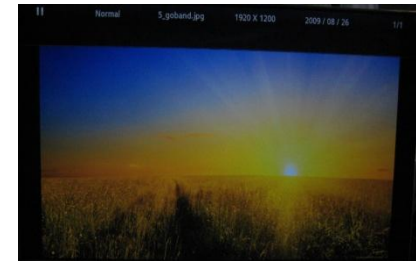
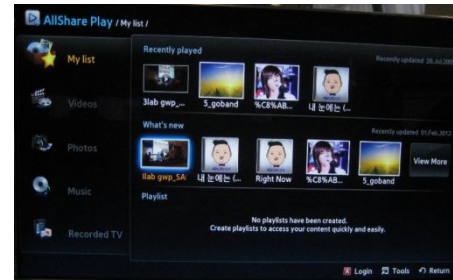

New Function of UE8Y*

Evolution Kit (Sold Separately)

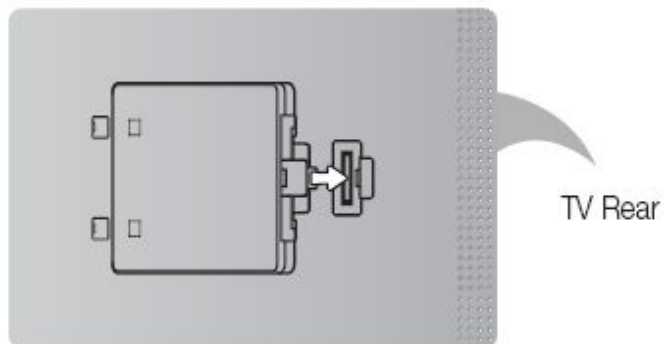

This socket is designed to accept an extension device called Evolution Kit. The Evolution Kit enables the TV to run a variety of the latest applications for a better user experience.

The Evolution Kit, which may not be available depending on the product, will be sold separately in 2013 or later.

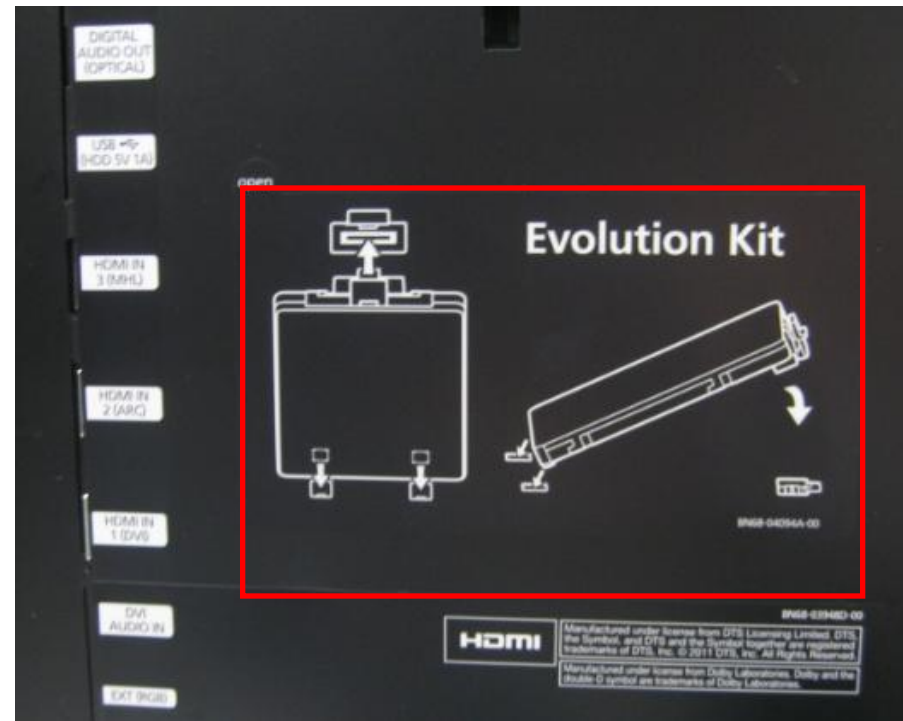



Disassembly and Reassembly

SAMSUNG

Disassembly and Reassembly

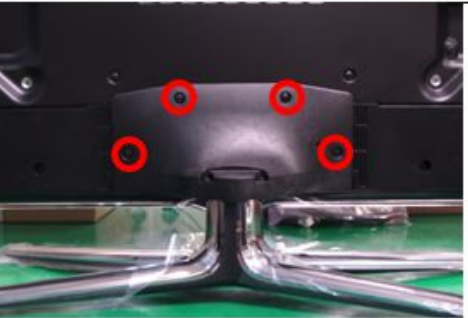
Disassembly and Reassembly

Description	Picture Description	Screws
<p>1. Place TV face down on cushioned table.</p> <p>Remove screws from the Stand.</p> <p>Remove stand.</p>	 A photograph showing the back of a black Samsung TV mounted on a silver stand. The TV is placed on a green cushioned surface.	
	 A close-up photograph of the back of the TV's stand. Four red circles are drawn around the screw holes on the stand's base.	 A photograph of a single screw with a blue circular highlight around it. <p>6003-001783 (M4,L12,Tapping)</p>
	 A photograph showing a hand pulling the silver stand away from the back of the TV. A red arrow points downwards from the top of the stand, indicating the direction of removal.	

Disassembly and Reassembly

4. Remove the screws of middle-cover



6001-002755
(M3,L6,Tapping)

5. Lift up and remove the middle-cover.



6. Caution: Remove the function cable and MoIP before removing the middle cover



6001-002756
(M3,L6,Machine)

Disassembly and Reassembly

* Rear view of 46"



7. Remove the Speakers(R/L)



8. Remove the screws of main board.

*Caution :Disconnect all cable connectors before removing any board



6001-002756
(M3,L6,Machine)

Disassembly and Reassembly

8. Remove the screws of main board.

*Caution :Disconnect all cable connectors before removing any board



6001-002756
(M3,L6,Machine)

9. Remove the screws of IP board.
Remove the IP board.



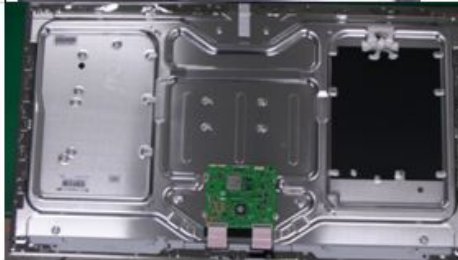

6001-002756
(M3,L6,Machine)

Panel

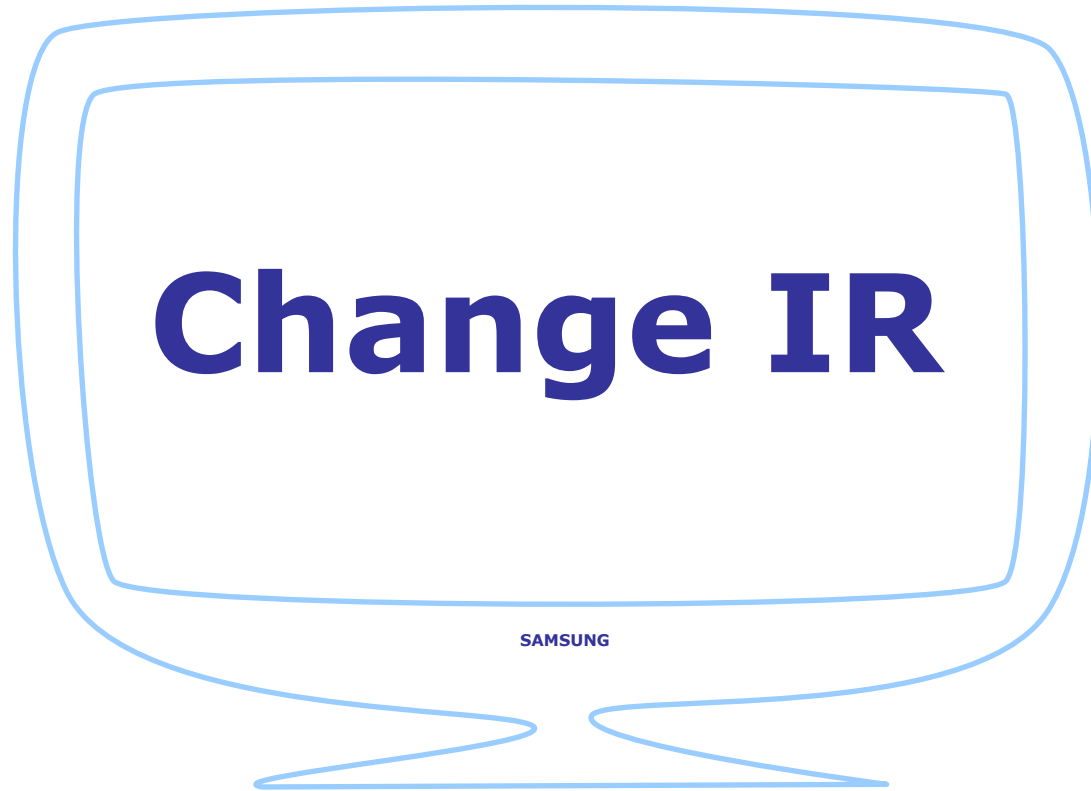

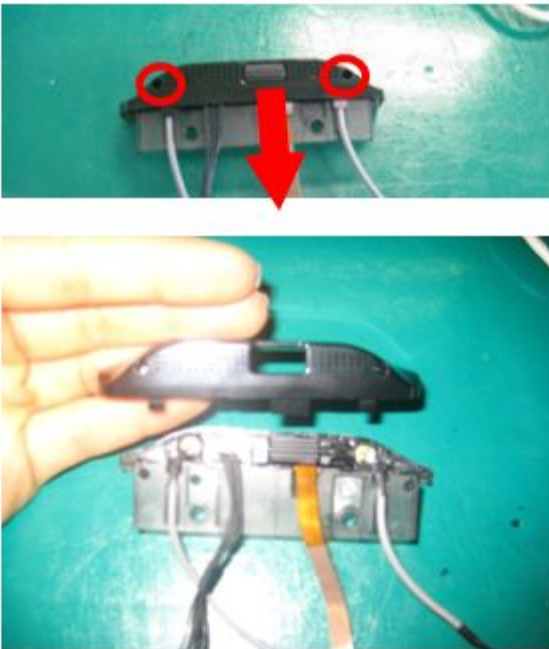

Description	Picture Description	Screws
<p>1. Place TV MoIP Module down on cushioned table.</p>	<p>Module</p> 	
<p>2. Remove screws from Module. And Pull up the back cover of MoIP Module</p>		<p>Be careful. This SCREW is very small. So easy to lose.</p> 

3. Separate the IR Receiver from the MOIP Module.



4. You can Change the IR Receiver.



※※Reassembly procedures are in the reverse order of disassembly procedures

Cables

SAMSUNG

Use	Image	CODE
MoIP Cable		40" : BN39-01650A
		46" : BN39-01650B
		55" : BN39-01650A
LVDS Cable		40" : BN96-22239H
		46" : BN96-22239L
		55" : BN96-22239J
Power Cable		40" : BN39-01475B
		46" : BN39-01475C
		55" : BN39-01475H
BT/WIFI/Function Cable		40" : BN39-01643A
		46" : BN39-01643B
		55" : BN39-01643C
DECO		40" : BN39-01643A
		46" : BN39-01643B
		55" : BN39-01643C

Troubleshooting



Service Mode

1. Check the various cable connections first.
 - Check to see if there is a burnt or damaged cable.
 - Check to see if there is a disconnected or loose cable connection.
 - Check to see if the cables are connected according to the connection diagram.
2. Check the power input to the Main Board.
3. How to distinguish if the problem is caused by Main board or T-Con
 - a. No Video : If the problem is No Video but BLU is on and Indication LED is blinking repeatedly and faster than normal booting, replace the T-Con board.
 - b. Distorted Picture : Check the inner patterns.

For All mode

GenoaP	Napoli Pre	Napoli post	Piecture	Problem
OK	OK	OK	NG	Main board or Signal Source
NG	OK	OK	NG	Main board
NG	NG	OK	NG	Main board or FRC setting
NG	NG	NG	NG	Main or LVDS cable or T-con or Panel

Only for HDMI mode (additional check)

HDMI	Picture	Problem
OK	NG	There is no problems after HDMI IC check HDMI source or HDMI jack.
NG	NG	There is no problems before HDMI IC check GenoaS pattern or LVDS cable or T-con

*How to check inner pattern?'

1. Factory mode (mute → 1 → 8 → 2 → Power on when TV is in 'stand-by mode')
2. Move to SVC menu
3. Move to Test Pattern
4. Check inner patterns. (This model only support FBE, READ PRE, READ POST)

Troubleshooting

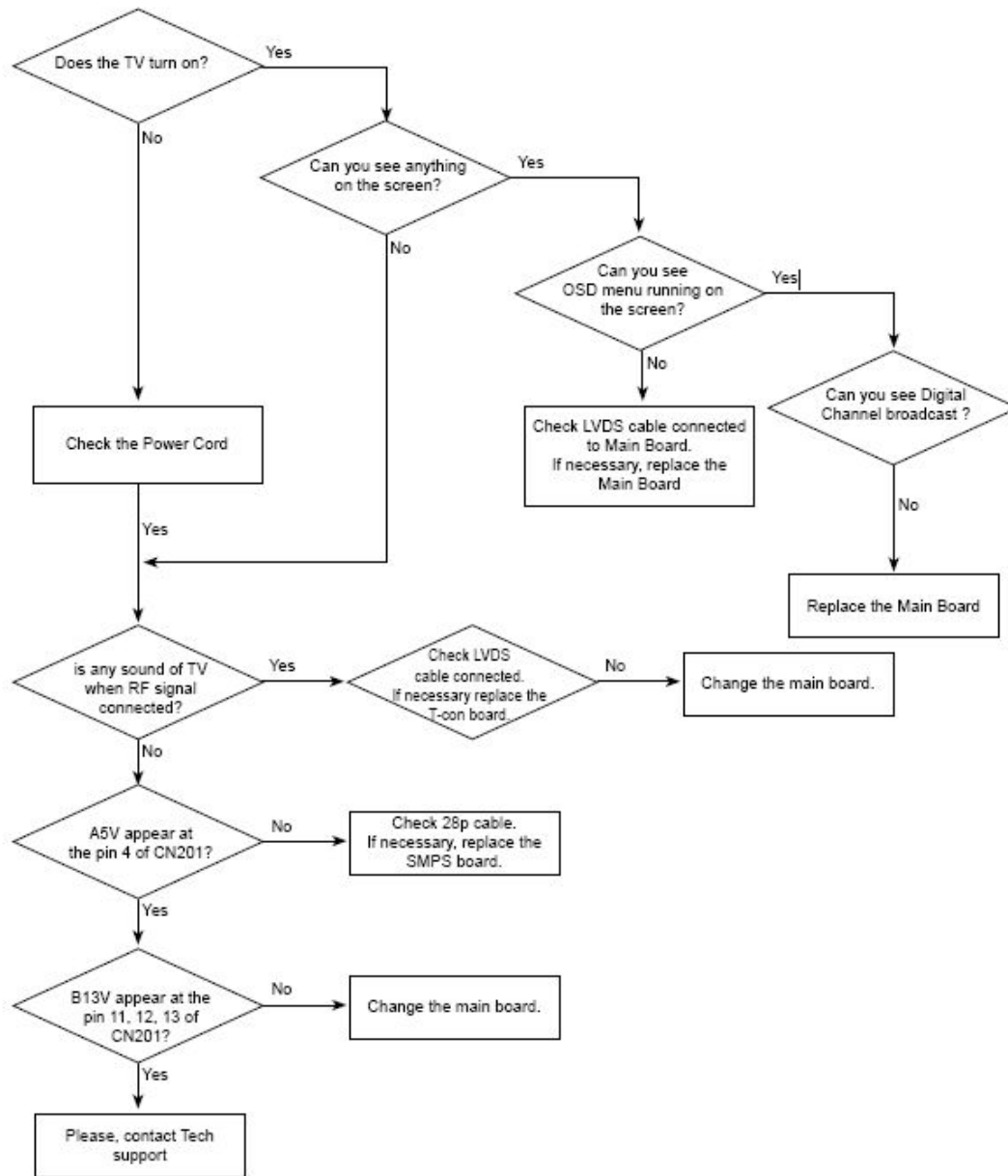

Troubleshooting

No Video

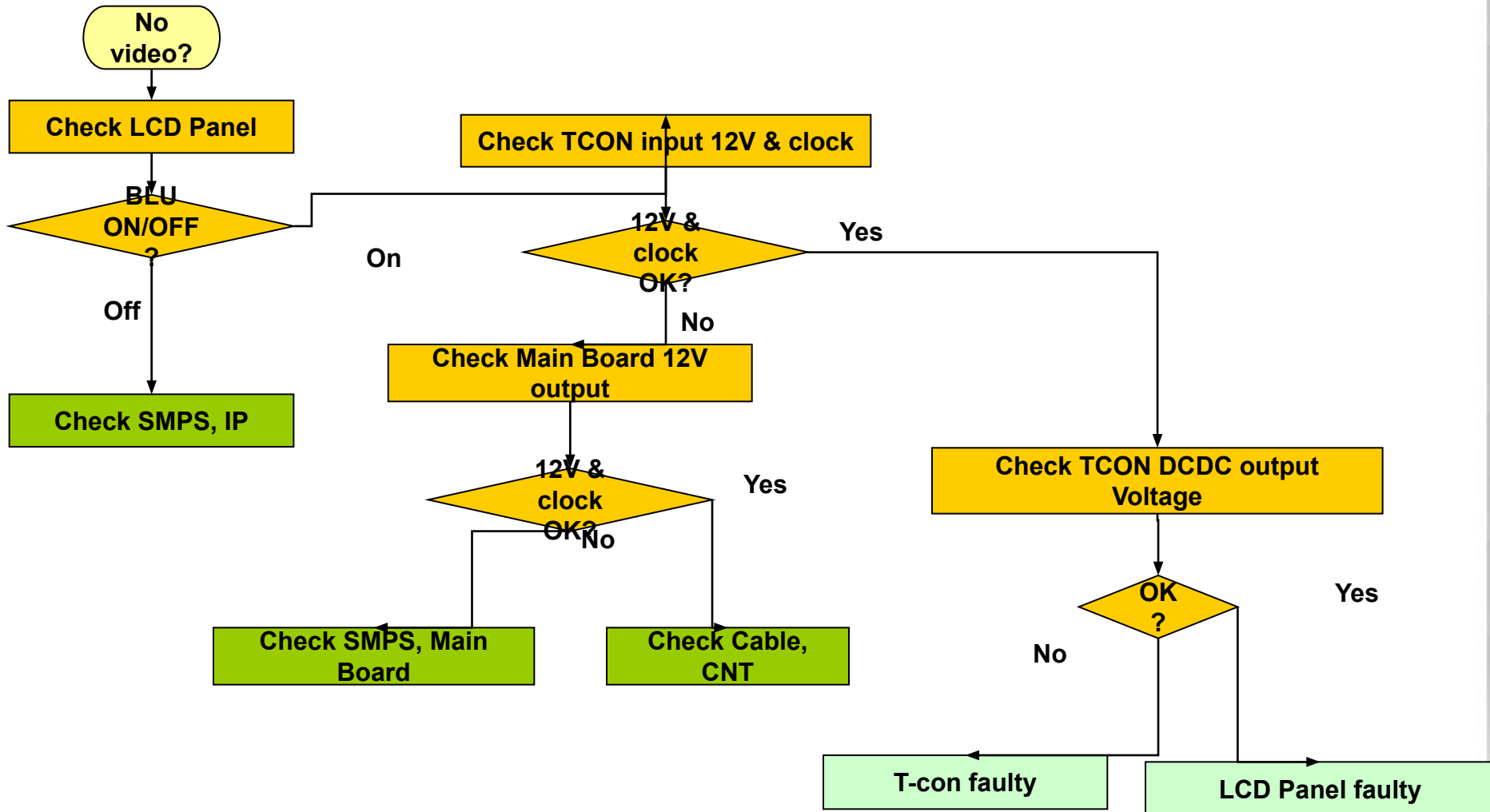

Picture Quality Problems

Problem	Solution
<p>. First of all, please perform the Picture Test and confirm that your TV is properly displaying test image. (Go to Menu → Support → Self Diagnosis → Picture Test) If the test image is properly displayed, the poor picture may be caused by the source or signal.</p>	
<ul style="list-style-type: none"> ● The TV image does not look as good as it did in the store. 	<ul style="list-style-type: none"> □ If you have an analogue cable / set top box, upgrade to a digital set top box. Use HDMI or Component cables to deliver HD (high definition) picture quality. □ Cable / Satellite subscribers: Try HD stations from the channel line up. □ Aerial connection: Try HD stations after performing Auto programme. <ul style="list-style-type: none"> - Many HD channels are up scaled from SD(Standard Definition) contents. □ Adjust the Cable/Set top box video output resolution to 1080i or 720p. □ Make sure you are watching TV at the minimum recommended distance based on the size and definition of the signal.
<ul style="list-style-type: none"> ● The picture is distorted: macro block error, small block, dots, pixelization 	<ul style="list-style-type: none"> □ Compression of video contents may cause picture distortion especially in fast moving pictures such as sports and action movies. □ Low signal level or bad quality can cause picture distortion. This is not a TV issue. □ Mobile phones used close to the TV (cca up to 1m) may cause noise in picture on analogue and digital TV.
<ul style="list-style-type: none"> ● Colour is wrong or missing. 	<ul style="list-style-type: none"> □ If you're using a component connection, make sure the component cables are connected to the correct jacks. Incorrect or loose connections may cause colour problems or a blank screen.
<ul style="list-style-type: none"> ● There is poor colour or brightness. 	<ul style="list-style-type: none"> □ Adjust the Picture options in the TV menu (go to Picture / Colour / Brightness / Sharpness) □ Adjust Energy Saving option in the TV menu (go to Menu → System → Eco Solution → Energy Saving) □ Try resetting the picture to view the default picture settings (go to Menu → Picture → Reset Picture)
<ul style="list-style-type: none"> ● There is a dotted line on the edge of the screen. 	<ul style="list-style-type: none"> □ If the picture size is set to Screen Fit, change it to 16:09. □ Change cable / satellite box resolution.
<ul style="list-style-type: none"> ● The picture is black and white. 	<ul style="list-style-type: none"> □ If you are using an AV composite input, connect the video cable (yellow) to the Green jack of component input 1 on the TV.
<ul style="list-style-type: none"> ● When changing channels, the picture freezes or is distorted or delayed. 	<ul style="list-style-type: none"> □ If your TV connected with a cable / set-top box, reconnect the AC cord and wait until the cable / set-top box reboots. □ Set the output resolution of the cable box to 1080i or 720p.

Sound Quality Problems

Problem	Solution
	<p>. First of all, please perform the Sound Test to confirm that your TV audio is properly operating. (Go to Menu → Support → Self Diagnosis → Sound Test) If the audio is OK, the sound problem may be caused by the source or signal.</p>
<ul style="list-style-type: none"> There is no sound or the sound is too low at maximum volume. 	<ul style="list-style-type: none"> <input type="checkbox"/> <input type="checkbox"/> <input type="checkbox"/> <input type="checkbox"/> Please check the volume of the external device connected to your TV.
<ul style="list-style-type: none"> The picture is good but there is no sound. 	<ul style="list-style-type: none"> <input type="checkbox"/> Set the Speaker Select option to TV Speaker in the sound menu. <input type="checkbox"/> If you are using an external device, make sure the audio cables are connected to the correct audio input jacks on the TV. <input type="checkbox"/> If you are using an external device, check the device's audio output option (ex. you may need to change your cable box's audio option)
<ul style="list-style-type: none"> The speakers are making an inappropriate noise. 	<ul style="list-style-type: none"> <input type="checkbox"/> <input type="checkbox"/> Check the cable connections. Make sure a video cable is not connected to an audio input. <input type="checkbox"/> For aerial or cable connections, check the signal strength. Low signal level may cause sound distortion.

No Picture / No video Problems

Problem	Solution
• The TV won't turn on.	<ul style="list-style-type: none"><input type="checkbox"/> Make sure the AC power cord is securely plugged in to the wall outlet and the TV.<input type="checkbox"/> Make sure the wall outlet is working.
• The TV turns off automatically.	<ul style="list-style-type: none"><input type="checkbox"/> <input type="checkbox"/> <input type="checkbox"/> <input type="checkbox"/> <input type="checkbox"/> Ensure the Sleep Timer is set to Off in the Setup menu.<input type="checkbox"/> If your PC is connected to the TV, check your PC power settings.<input type="checkbox"/> Make sure the AC power cord is plugged in securely to the wall outlet and the TV.<input type="checkbox"/> When watching TV from an aerial or cable connection, the TV will turn off after 10~15 minutes if there is no signal.
• There is no picture/Video.	<ul style="list-style-type: none"><input type="checkbox"/> Check cable connections (remove and reconnect all cables connected to the TV and external devices).<input type="checkbox"/> Set your external devices' (Cable / Set top Box, DVD, Blu-ray etc) video outputs to match the connections to the TV input. For example, if an external device's output is HDMI, it should be connected to an HDMI input on the TV.<input type="checkbox"/> Make sure your connected devices are powered on.<input type="checkbox"/> Be sure to select the TV's correct source by select Source using your remote.
• This file may not be playable properly.	<ul style="list-style-type: none"><input type="checkbox"/> This may appear because of high bit rate of content. Content generally will play but could experience some playability issue.

RF (Cable/Aerial) Connection Problems

Problem	Solution
The TV is not receiving all channels.	<ul style="list-style-type: none">• Make sure the coaxial cable is connected securely.• Please try Auto Program to add available channels to the channel list. Go to MENU - Channel - Auto Program then select Auto and make sure the correct Cable TV signal type is set in the menu. There are 3 options (STD, HRC and IRC)• Verify the Antenna is positioned correctly.
No Caption on digital channels	<ul style="list-style-type: none">• Check Caption Setup menu. Try changing Caption Mode Service1 to CC1.• Some channels may not have caption data.
The picture is distorted: macro block error, small block, dots, pixelization.	<ul style="list-style-type: none">• Compression of video contents may cause picture distortion, especially with fast moving pictures such as sports and action movies.• A low signal can cause picture distortion. This is not a TV problem.

PC Connection Problems

Problem	Solution
"PC" is always shown on the source list, even if a PC is not connected.	<ul style="list-style-type: none">• This is normal; "PC" is always shown on the source list, regardless of whether a PC is connected.
The video is OK but there is no audio.	<ul style="list-style-type: none">• If you are using an HDMI connection, check the audio output setting on your PC.

Other Problems

Problem	Solution
The picture won't display in full screen.	<ul style="list-style-type: none"> • HD channels will have black bars on either side of the screen when displaying up scaled SD (4:3) contents. • Black bars on the Top & Bottom will be shown on movies that have aspect ratios different from your TV. • Adjust the picture size options on your external device or TV to full screen.
Caption on TV menu is greyed out.	<ul style="list-style-type: none"> • Caption can not be selected in the TV menu when connected via HDMI or Component. • Caption must be activated on the external device.
There is a plastic smell from the TV.	<ul style="list-style-type: none"> • This smell is normal and will dissipate over time.
The TV Signal Information is unavailable in the Self Diagnostic Test menu.	<ul style="list-style-type: none"> • This function is only available with digital channels from an Antenna / RF / Coax connection.
The TV is tilted to the side.	<ul style="list-style-type: none"> • Remove the base stand from the TV and reassemble it.
The channel menu is greyed out (unavailable).	<ul style="list-style-type: none"> • The Channel menu is only available when the TV source is selected.
Your settings are lost after 30 minutes or every time the TV is turned off.	<ul style="list-style-type: none"> • If the TV is in the Store Demo mode, it will reset audio and picture settings every 30 minutes. <p>Change the settings from Store Demo mode to Home Use mode in the Plug & Play procedure. Press the SOURCE button to select TV mode, and go to MENU → System → Plug & Play → ENTER</p>
You have intermittent loss of audio or video.	<ul style="list-style-type: none"> • Check the cable connections and reconnect them. • Loss of audio or video can be caused by using overly rigid or thick cables. Make sure the cables are flexible enough for long term use. If mounting the TV to a wall, we recommend using cables with 90 degree connectors.
You see small particles when you look closely at the edge of the frame of the TV.	<ul style="list-style-type: none"> • This is part of the product's design and is not a defect.

Other Problems

Problem	Solution
POP (TV's internal banner ad) appears on the screen.	•• Select Home Use under Plug & Play mode. For details, refer to Plug & Play Feature.
Melody is not played when television is turned off.	If the Volume is Mute or set to Volume level 0 or Melody mode is off, or in the case of automatic power off due to the 'Sleep timer' function, then no melody will be played at power off.
When the channel is changed, volume gradually gets louder.	It takes about 2 seconds to adapt to volume levels on different channels.
Even if I change sound mode, monitor out sound is constant.	The monitor out sound is independent from the main sound output, therefore changes to the audio output will not affect the monitor output.
Even if I set mute on, monitor out is still outputting.	The monitor out sound is independent from the main Speaker output, therefore to Mute or adjust the volume of monitor out a separate external decoder (AMP) is required.
I set Mute on but sound is still outputting.	The volume buttons and MUTE buttons do not operate when the Speaker Select is set to External Speaker. Please set the volume on your Home theater.
	<ul style="list-style-type: none"> ■ Speaker Settings <ul style="list-style-type: none"> ● Speaker Select (External Speaker / TV Speaker) <ul style="list-style-type: none"> A sound echo may occur due to a difference in decoding speed between the main speaker and the audio receiver. In this case, set the TV to External Speaker. ☞ When Speaker Select is set to External Speaker, the volume and MUTE buttons will not operate and the sound settings will be limited. ☞ When Speaker Select is set to External Speaker. <ul style="list-style-type: none"> ● TV Speaker: Off, External Speaker: On ☞ When Speaker Select is set to TV Speaker. <ul style="list-style-type: none"> ● TV Speaker: On, External Speaker: On ☞ If there is no video signal, both speakers will be mute.
There is a vertical line(red,green,blue) on picture.	This occurs when TV set has a defect on one line from DATA SOURCE DRIVER IC. Contact Samsung Service centre to resolve this problem.

Other Problems

Problem	Solution
I can not hear any sound from speaker in HDMI mode when using a DVI-HDMI conversion cable.	If the input signal is DVI RGB signal through an HDMI conversion cable, there is no digital sound data, you can not hear any sound. A DVI connection does not carry any sound data. You should connect an audio cable to the appropriate input jack for a separate audio channel.
Although the TV caption shows HD, the visual quality is not satisfactory.	The HD caption that appears when switching channels or when pressing the Information button on the remote control means the selected channel is simply a digital channel. If the broadcasting station converts an analog signal into digital and transmits the signal, the visual quality may not be perfect.
The visual qualities of digital channels vary	The visual qualities of digital channels may vary depending on the original production method(analog or digital) → Grouping displayed information when switching channels. → If the original production method is digital: High visual quality program. → If the original production method is analog: The digital program displayed on the screen is originally an analog program which has been converted. The visual quality is of an SD grade.
HDMI Black Level does not work on HDMI device that is output by YCbCr.	This function is active only when the an external device (DVD player, STB etc.) is connected to the TV via HDMI(RGB Signal).
There is no sound when using HDMI mode.	If you use external equipment that support low HDMI version, sound may not be output at TV that support new HDMI version(HDMI1.3). → If sound does not work, use HDMI2 IN for video input and DVI IN(HDMI1) port[R(red) - AUDIO - L(white)] for audio input.

Supported Multi Media format(photo, music, video)

File Extension	Container	Video Codec	Resolution	Frame rate (fps)	Bit rate (Mbps)	Audio Codec			
*.avi	AVI MKV ASF MP4 3GP VRO MPG VRO VOB PS TS	DivX 3.11/4.x/5.x/6.1	1920 x 1080	6 - 30	30	AC3 LPCM ADMPCM(IMA, MS) AAC HE-AAC WMA DD+ MPEG(MP3) DTS Core DRA			
*.mkv		MPEG4 SP/ASP							
*.asf		H.264 BP/MP/HP							
*.wmv		Motion JPEG							
*.mp4		Window Media Video v9							
*.mov		MPEG2							
*.3gp		MPEG1							
*.vro		VP6					640 x 480	4	
*.mpg		SVAF					1920 x 1080	24 / 25 / 30	40
*.mpeg		MVC							
*.ts	TS	MVC	1920 x 1080	24 / 25 / 30	40				
*.tp									
*.trp	TS	MVC	1920 x 1080	24 / 25 / 30	40				
*.m2ts									
*.mts	TS	MVC	1920 x 1080	24 / 25 / 30	40				
*.divx									
*.webm	WebM	VP8		6 - 30	8	Vorbis			

Video Decoder	Audio codec
<ul style="list-style-type: none"> • Supports up to H.264, Level 4.1 • H.264 FMO / ASO / RS, VC1 SP / MP / AP L4 and AVCHD are not supported. • For all Video codecs except MVC, VP8, VP6: <ul style="list-style-type: none"> -- Below 1280 x 720: 60 frame max -- Above 1280 x 720: 30 frame max -- GMC 2 over is not supported. • Supports only SVAF Top/Bottom and Side by Side. • Supports only BD MVC Spec. 	<ul style="list-style-type: none"> • WMA 10 Pro supports up to 5.1 channel. WMA lossless audio is not supported. • RealAudio 10 lossless is not supported. • QCELP, AMR NB/WB are not supported. • If Vorbis is only in Webm container, supports up to 2 channel

Supported Multi Media format(video)

File Extension	Container	Video Codec	Resolution	Frame rate (fps)	Bit rate (Mbps)	Audio Codec		
*.avi *.mkv *.asf *.wmv *.mp4 *.mov *.3gp *.vro *.mpg *.mpeg *.ts *.tp *.trp *.m2ts *.mts *.divx	AVI MKV ASF MP4 3GP VRO VOB PS TS	DIVX 3.11/4.x/5.x/6.1	1920 x 1080	6 - 30	30	AC3 LPCM ADMPCM(IMA, MS) AAC HE-AAC WMA DD+ MPEG(MP3) DTS Core DRA		
		MPEG4 SP/ASP						
		H.264 BP/MP/HP						
		Motion JPEG						
		Window Media Video v9						
		MPEG2						
		MPEG1						
		VP6					640 x 480	4
		SVAF					1920 x 1080	30
		MVC						24 / 25 / 30
*.webm	WebM	VP8	1920 x 1080	6 - 30	8	Vorbis		