

# Long-Range Order and Superconductivity

*Alexander Gabovich, KPI,*

Lecture 1

# Density matrix in quantum mechanics

If one has a large closed quantum-mechanical system with co-ordinates  $q$  and a subsystem with co-ordinates  $x$ , its wave function  $\Psi(q,x)$  **generally speaking** does not decompose into two ones, each dependent on  $q$  and  $x$ .

If  $f$  is a physical quantity, its mean value is given by

$$\bar{f} = \iint \Psi^*(q, x) \hat{f} \Psi(q, x) dq dx.$$

The function

$$\rho(x, x') = \int \Psi(q, x) \Psi^*(q, x') dq$$

is the density matrix

Thus, even if the state is not described by a wave function, it may be described by the density matrix together with all relevant physical quantities.

# Density matrix in quantum mechanics

In the pure case, when the system concerned is described by the wave function one has

$$\rho(x, x') = \Psi(x)\Psi^*(x')$$

One can generalize this formalism to the case of two or more particles

$$\hat{\rho} = \langle \Psi_{\alpha'}^\dagger(\mathbf{r}'_1) \Psi_\alpha^\dagger(\mathbf{r}_1) \Psi_\alpha(\mathbf{r}) \Psi_{\alpha'}(\mathbf{r}') \rangle$$

The two-particle density particle can be factorized in such a way:

$$\hat{\rho} \rightarrow \langle \Psi_{\alpha'}^\dagger(\mathbf{r}'_1) \Psi_\alpha(\mathbf{r}) \rangle \langle \Psi_\alpha^\dagger(\mathbf{r}_1) \Psi_{\alpha'}(\mathbf{r}') \rangle$$

with  $|\mathbf{r}'_1 - \mathbf{r}_1| \rightarrow \infty$ ,  $|\mathbf{r}'_1 - \mathbf{r}|$  and  $|\mathbf{r}' - \mathbf{r}_1|$  being finite.

It means that we have a so-called diagonal long-range order (DLRO). For instance, one can take a [charge-density-wave order](#) as an example. In this case, the wave operators are the **Fermi** ones. The coupling is between electrons and holes (excitonic dielectric) or different branches of the same one-dimensional Fermi surface (Peierls dielectric). If  $\alpha' = \alpha$ , one has a simple [crystalline order](#).

# Density matrix in quantum mechanics

Another kind of the long-range order is the following:

$|\mathbf{r} - \mathbf{r}_1| \rightarrow \infty$  while  $|\mathbf{r}'_1 - \mathbf{r}_1|$  and  $|\mathbf{r}' - \mathbf{r}|$  remain finite. Then

$$\hat{\rho} \rightarrow \langle \Psi_{\alpha'}^\dagger(\mathbf{r}'_1) \Psi_{\alpha}^\dagger(\mathbf{r}_1) \rangle \langle \Psi_{\alpha}(\mathbf{r}) \Psi_{\alpha'}(\mathbf{r}') \rangle$$

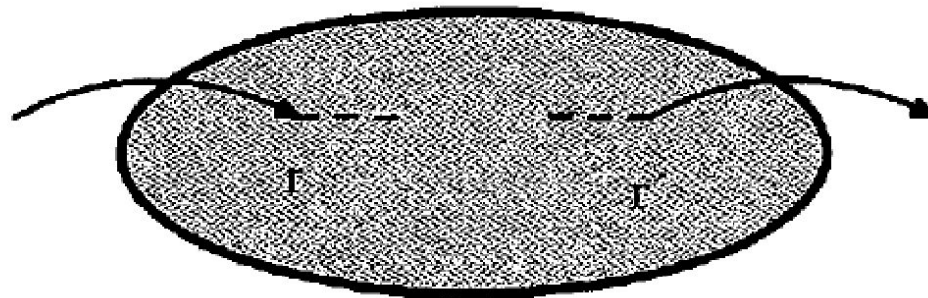
It is the so-called off-diagonal long-range order (ODLRO). It is anomalous in the sense that here the mean value of the state with an extra pair of particles or the absence of a pair exists. We shall discuss such a possibility for superconductivity when the Cooper pair is the characteristic anomalous mean value but it is valid for other systems as well. For instance, it is valid for superfluid systems, such as a superfluid  $^4\text{He}$ . In this case it is reasonable to write a one-particle density matrix (operator) for the Bose field:

$$\rho(r, r') = \langle \psi^*(r) \psi(r') \rangle = \psi^*(r) \psi(r') \rightarrow n_0$$
$$|\mathbf{r}-\mathbf{r}'| \rightarrow \infty$$

Here, one sees that since  $r$  and  $r'$  are not equal, the non-zero matrix element is off-diagonal, indeed. It survives for the infinite distance.

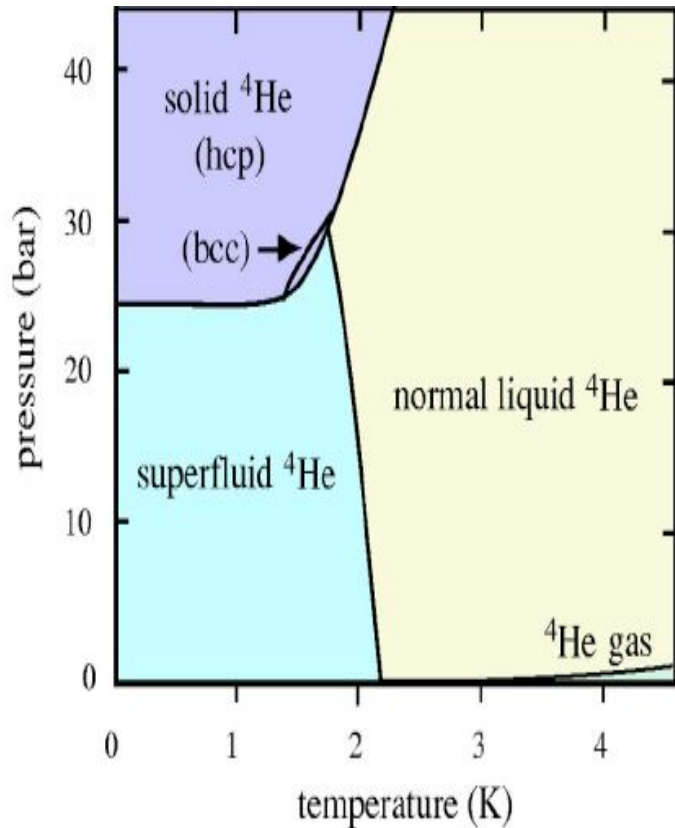
# Off-diagonal long-range order

Here  $n_0 = N_0/V$  is the Bose-Einstein condensate contribution to the density matrix.

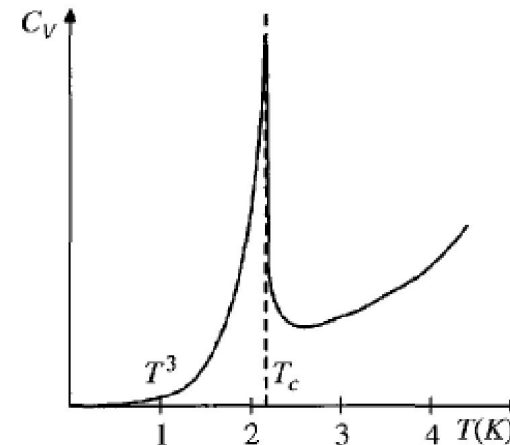


**Fig. 5.3** Schematic illustrating the interpretation of ODLRO in the one particle density matrix  $\rho_1(\mathbf{r} - \mathbf{r}')$ . A particle is inserted into the condensate at  $\mathbf{r}$ , and a particle is removed from it at  $\mathbf{r}'$ . In a condensate, this process has a coherent quantum amplitude and phase, however great the separation between  $\mathbf{r}$  and  $\mathbf{r}'$ .

# Long-range orders below critical lines of phase transitions ( $^4\text{He}$ )



**FIGURE 4.3** Sketch of the  $P$ - $T$  phase diagram for helium-4. The letters S, L, and V denote solid, liquid, and vapor phases. The critical point is  $T_c = 5.19\text{K}$  and  $P_c = 227\text{kPa} = 2.24\text{atm}$ . The solid-liquid coexistence curve starts at  $P_s = 2.5\text{MPa} = 25\text{atm}$  at  $T = 0\text{K}$  and does not intersect the liquid-vapor coexistence curve. The  $\lambda$ -line is the continuous phase transition between the normal liquid and the superfluid phase. The superfluid phase transition temperature at the liquid-vapor coexistence line is  $T_\lambda = 2.18\text{K}$ .



**Fig. 2.3** Specific heat of  $^4\text{He}$ . At the critical temperature  $T_c$  there is a singularity shaped like the Greek symbol  $\lambda$ . This  $\lambda$  transition belongs to the three-dimensional XY model universality class.

# Phase transitions

As early as 1937 Landau attempted a unified description of all *second-order* phase transitions — second-order in the sense that the second derivatives of the free energy, namely the specific heat and the magnetic susceptibility (or isothermal compressibility, in the case of fluids), show a divergence while the first derivatives, namely the entropy and the magnetization (or density, in the case of fluids), are continuous at the critical point. He emphasized the importance of an *order parameter*  $m_0$  (which would be zero on the high-temperature side of the transition and nonzero on the low-temperature side) and suggested that the basic features of the critical behavior of a given system may be determined by expanding its free energy in powers of  $m_0$  (for we know that, in the close vicinity of the critical point,  $m_0 \ll 1$ ). He also argued that in the absence of the *ordering field* ( $h = 0$ ) the up-down symmetry of the system would require that the proposed expansion contain only *even* powers of  $m_0$ . Thus, the zero-field free energy

$$\psi_0(t, m_0) = q(t) + r(t)m_0^2 + s(t)m_0^4 + \dots \quad \left( t = \frac{T - T_c}{T_c}, |t| \ll 1 \right)$$

This is the **phenomenological** way to describe all kinds of phase transitions. It was applied to superconductivity. But what is superconductivity from the point of view based on observations?

# MICHAEL FARADAY, THE PRECURSOR OF LIQUEFACTION



Michael Faraday, 1791-1867

He liquefied all gases known to him except  $O_2$ ,  $N_2$ ,  $CO$ ,  $NO$ ,  $CH_4$ ,  $H_2$ . Permanent gases? – NO!

COLD WAR OF  
LIQUEFACTION:  $O_2$  –  
Louis-Paul Cailletet (France) and  
Raoul-Pierre Pictet (Switzerland)  
[1877];  $N_2$ , Ar – Zygmund  
Wróblewski and Karol Olszewski  
(Poland) [1883]

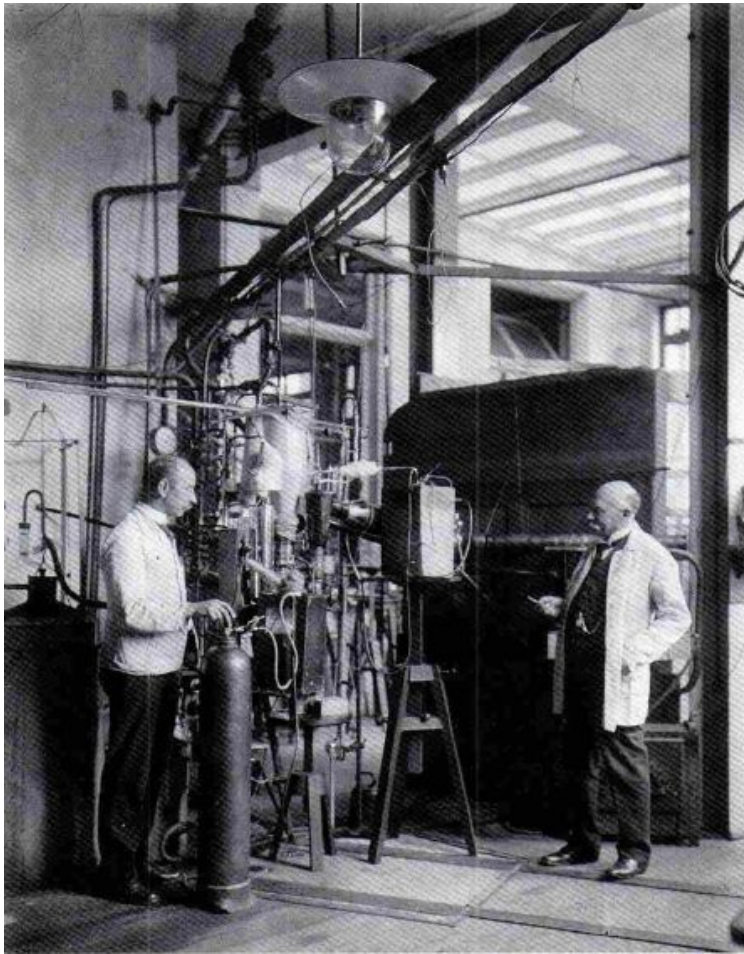


# JAMES DEWAR, THE COMPETITOR – A MAN, WHO LIQUEFIED HYDROGEN IN 1898



A Dewar flask in the hands of the inventor. James Dewar's laboratory in the basement of the Royal Institution in London appears as the background.

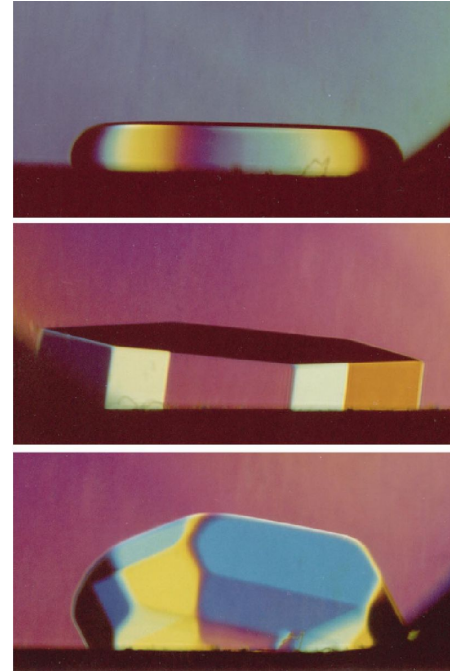
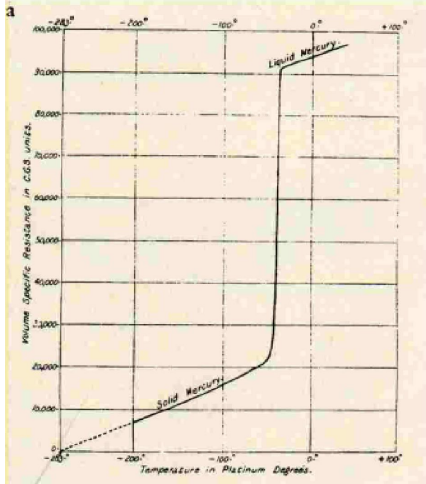
## KAMERLINGH-ONNES, THE WINNER – PHYSICIST AND ENGINEER (Nobel Prize in Physics, 1913)



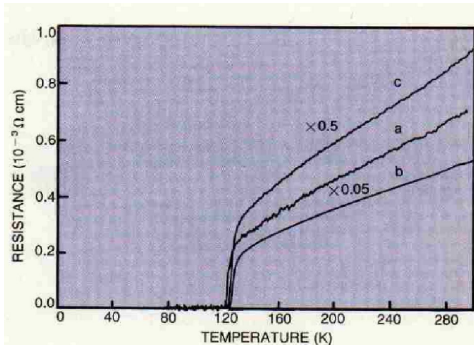
Heike Kamerlingh Onnes (right) in his Cryogenic Laboratory at Leiden University, with his assistant Gerrit Jan Flim, around the time of the discovery of superconductivity: 1911

# LOW TEMPERATURE STUDIES USING LIQUID HELIUM LED TO NEW DISCOVERIES: NOT ONLY SUPERCONDUCTIVITY!

Phase  
transition in  
Hg resistance,  
Dewar (1896)

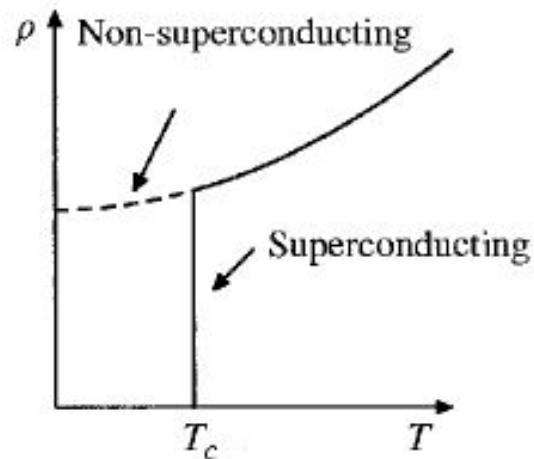


Superconducting  
transition for  
Tl-based oxides  
on different  
Substrates  
Lee (1991)



Crystallization waves on many-facet  
surfaces of  $^4\text{He}$  crystals  
Balibar (1994)

# Superconducting phenomenology



**Fig. 3.1** Resistivity of a typical metal as a function of temperature. If it is a non-superconducting metal (such as copper or gold) the resistivity approaches a finite value at zero temperature, while for a superconductor (such as lead, or mercury) all signs of resistance disappear suddenly below a certain temperature,  $T_c$ .

**Table 3.1** Some selected superconducting elements and compounds

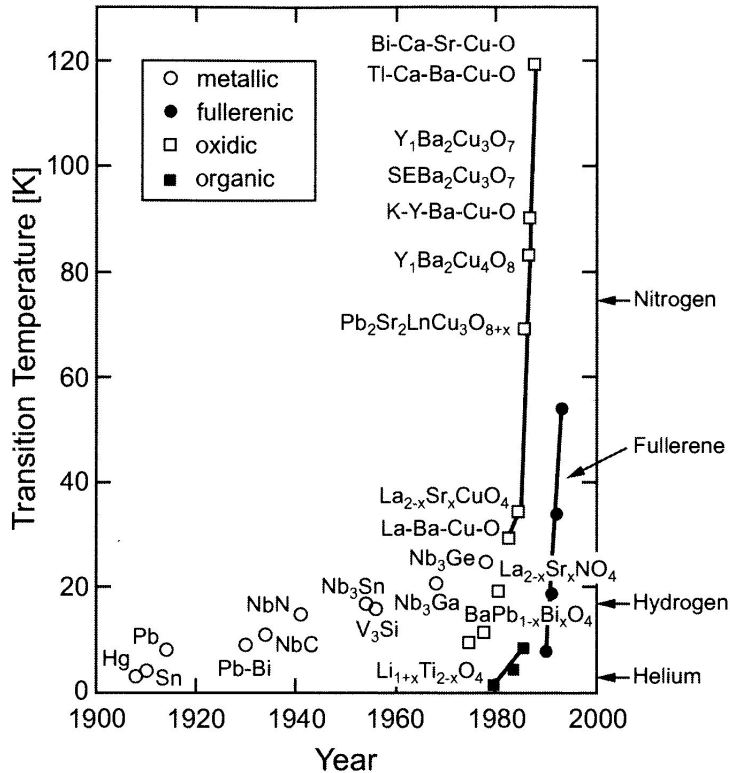
Substance	$T_c$ (K)	
Al	1.2	
Hg	4.1	First superconductor, discovered 1911
Nb	9.3	Highest $T_c$ of an element at normal pressure
Pb	7.2	
Sn	3.7	
Ti	0.39	
Tl	2.4	
V	5.3	
W	0.01	
Zn	0.88	
Zr	0.65	
Fe	2	High pressure
H	300	Predicted, under high pressure
O	30	High pressure, maximum $T_c$ of any element
S	10	High pressure
Nb <sub>3</sub> Ge	23	A15 structure, highest known $T_c$ before 1986
Ba <sub>1-x</sub> Pb <sub>x</sub> BiO <sub>3</sub>	12	First perovskite oxide structure
La <sub>2-x</sub> Sr <sub>x</sub> CuO <sub>4</sub>	35	First high $T_c$ superconductor
YBa <sub>2</sub> Cu <sub>3</sub> O <sub>7-<math>\delta</math></sub>	92	First superconductor above 77 K
HgBa <sub>2</sub> Ca <sub>2</sub> Cu <sub>3</sub> O <sub>8+<math>\delta</math></sub>	135–165	Highest $T_c$ ever recorded
K <sub>3</sub> C <sub>60</sub>	30	Fullerene molecules
YNi <sub>2</sub> B <sub>2</sub> C	17	Borocarbide superconductor
MgB <sub>2</sub>	38	Discovery announced in January 2001
Sr <sub>2</sub> RuO <sub>4</sub>	1.5	Possible <i>p</i> -wave superconductor
UPt <sub>3</sub>	0.5	“Heavy fermion” exotic superconductor
(TMTSF) <sub>2</sub> ClO <sub>4</sub>	1.2	Organic molecular superconductor
ET-BEDT	12	Organic molecular superconductor

# SUPERCONDUCTIVITY AMONG ELEMENTS

superconductors at ambient pressure																	
superconductors at high pressure																	
H																	He
Li	Be											B	C	N	O	F	Ne
Na	Mg											Al	Si	P	S	Cl	Ar
K	Ca	Sc	Ti	V	Cr	Mn	Fe	Co	Ni	Cu	Zn	Ga	Ge	As	Se	Br	Kr
Rb	Sr	Y	Zr	Nb	Mo	Tc	Ru	Rh	Pd	Ag	Cd	In	Sn	Sb	Te	I	Xe
Cs	Ba	*	Hf	Ta	W	Re	Os	Ir	Pt	Au	Hg	Tl	Pb	Bi	Po	At	Rn
Fr	Ra	**	Rf	Db	Sg	Bh	Hs	Mt									
		*	La	Ce	Pr	Nd	Pm	Sm	Eu	Gd	Tb	Dy	Ho	Er	Tm	Yb	Lu
		**	Ac	Th	Pa	U	Np	Pu	Am	Cm	Bk	Cf	Es	Fm	Md	No	Lr

Over the last 100 years, an ever bigger range of elements in the periodic table has been found to superconduct. Shown here are those elements that superconduct at ambient pressure, shaded according to when this ability was first unearthed (yellow/orange), and those elements that superconduct only at high pressure (purple).

# SUPERCONDUCTIVITY, A MIRACLE FOUND BY KAMERLINGH-ONNES



**Figure 7-15** History of superconductivity; transition temperatures are plotted versus the year of discovery. On the right side the boiling points of helium, hydrogen, and nitrogen are marked.



Superconducting levitation based on Meissner effect

## ANNIVERSARIES OF key discoveries

- 1908-2008 (100) Helium liquefying
- 1911-2011 (100) Superconductivity
- 1933-2013 (70) Meissner-Ochsenfeld effect
- 1956-2011 (55) Cooper pairing concept
- 1962-2012 (50) Josephson effect
- 1971-2011 (40) Superfluidity of  $^3\text{He}$
- 1986-2011 (25) High- $T_c$  oxide superconductivity
- 2001-2011 (10)  $\text{MgB}_2$  with  $T_c = 39$  K
- 2008-2013 (5) Iron-based superconductors with  $T_c = 75$  K  
(in single layers of FeSe)

# PHENOMENOLOGY. NORMAL METALS

The idea that metals are good electrical conductors because the electrons move freely between the atoms was first developed by Drude in 1900, only 5 years after the original discovery of the electron.

Although Drude's original model did not include quantum mechanics, his formula for the conductivity of metals remains correct even in the modern quantum theory of metals. To briefly recap the key ideas in the theory of metals, we recall that the wave functions of the electrons in crystalline solids obey **Bloch's theorem**,<sup>1</sup>

$$\psi_{n\mathbf{k}}(\mathbf{r}) = u_{n\mathbf{k}}(\mathbf{r})e^{i\mathbf{k}\cdot\mathbf{r}}, \quad (3.1)$$

where  $u_{n\mathbf{k}}(\mathbf{r})$  is a function which is periodic,  $\hbar\mathbf{k}$  is the crystal momentum, and  $\mathbf{k}$  takes values in the first Brillouin zone of the reciprocal lattice. The energies of these Bloch wave states give the **energy bands**,  $\epsilon_{n\mathbf{k}}$ , where  $n$  counts the different electron bands. Electrons are fermions, and so at temperature  $T$  a state with energy  $\epsilon$  is occupied according to the **Fermi-Dirac** distribution

$$f(\epsilon) = \frac{1}{e^{\beta(\epsilon-\mu)} + 1}. \quad (3.2)$$

The chemical potential,  $\mu$ , is determined by the requirement that the total density of electrons per unit volume is

$$\frac{N}{V} = \frac{2}{(2\pi)^3} \sum_n \int \frac{1}{e^{\beta(\epsilon_{n\mathbf{k}}-\mu)} + 1} d^3k, \quad (3.3)$$

Metallic conduction is dominated by the thin shell of quantum states with energies  $\epsilon_F - k_B T < \epsilon < \epsilon_F + k_B T$ , since these are the only states which can be thermally excited at temperature  $T$ . We can think of this as a low density gas of "electrons" excited into empty states above  $\epsilon_F$  and of "holes" in the occupied states below  $\epsilon_F$ . In this **Fermi gas** description of metals the electrical conductivity,  $\sigma$ , is given by the Drude theory as,

$$\sigma = \frac{ne^2\tau}{m}, \quad (3.5)$$

where  $m$  is the effective mass of the conduction electrons,<sup>2</sup>  $-e$  is the electron charge and  $\tau$  is the average lifetime for free motion of the electrons between collisions with impurities or other electrons.

The conductivity is defined by the **constitutive equation**

$$\mathbf{j} = \sigma\mathbf{E}. \quad (3.6)$$

Here  $\mathbf{j}$  is the electrical current density which flows in response to the external electric field,  $\mathbf{E}$ . The resistivity  $\rho$  obeys

$$\mathbf{E} = \rho\mathbf{j}, \quad (3.7)$$

and so  $\rho$  is simply the reciprocal of the conductivity,  $\rho = 1/\sigma$ . Using the Drude formula we see that

$$\rho = \frac{m}{ne^2}\tau^{-1}, \quad (3.8)$$

and so the resistivity is proportional to the **scattering rate**,  $\tau^{-1}$  of the conduction electrons. In the SI system the resistivity has units of  $\Omega\text{m}$ , or is more often quoted in  $\Omega\text{cm}$ .



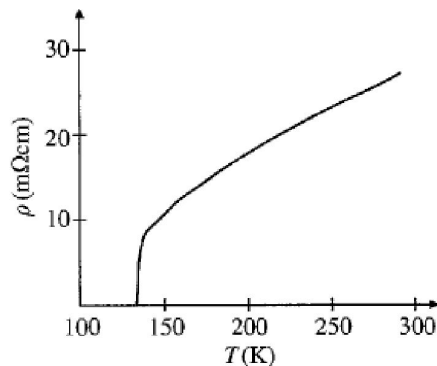
# Superconducting phenomenology

As we have seen, in superconductors the resistivity,  $\rho$ , becomes zero, and so the conductivity  $\sigma$  appears to become infinite below  $T_c$ . To be consistent with the constitutive relation, Eq. 3.6, we must always have zero electric field,

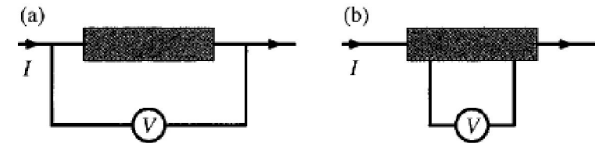
$$\mathcal{E} = 0,$$

at all points inside a superconductor. In this way the current,  $\mathbf{j}$ , can be finite. So we have current flow without electric field.

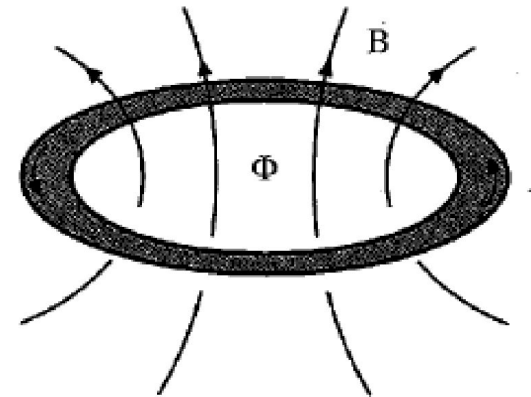
Notice that the change from finite to zero resistivity at the superconducting critical temperature  $T_c$  is very sudden, as shown in Fig. 3.1. This represents a thermodynamic phase transition from one state to another.



**Fig. 3.2** Resistivity of  $\text{HgBa}_2\text{Ca}_2\text{Cu}_3\text{O}_{8+\delta}$  as a function of temperature (adapted from data of Chu 1993). Zero resistance is obtained at about 135 K, the highest known  $T_c$  in any material at normal pressure. In this material  $T_c$  approaches a maximum of about 165 K under high pressure. Note the rounding of the resistivity curve just above  $T_c$ , which is due to superconducting fluctuation effects. Also, well above  $T_c$  the resistivity does not follow the expected Fermi liquid behavior.



**Fig. 3.3** Measurement of resistivity by (a) the two terminal method, (b) the four terminal method. The second method, (b), is much more accurate since no current flows through the leads measuring the voltage drop across the resistor, and so the resistances of the leads and contacts are irrelevant.



**Fig. 3.4** Persistent current around a superconducting ring. The current maintains a constant magnetic flux,  $\Phi$ , through the superconducting ring.

# Magnetic field, magnetic induction, and magnetization

The screening currents produce a magnetization in the sample,  $\mathbf{M}$  per unit volume, defined by

$$\nabla \times \mathbf{M} = \mathbf{j}_{\text{int}}. \quad (3.21)$$

As in the theory of magnetic media (Blundell 2001) we also define a magnetic field  $\mathbf{H}$  in terms of the external currents only

$$\nabla \times \mathbf{H} = \mathbf{j}_{\text{ext}}. \quad (3.22)$$

The three vectors  $\mathbf{M}$  and  $\mathbf{H}$  and  $\mathbf{B}$  are related by<sup>5</sup>

$$\mathbf{B} = \mu_0(\mathbf{H} + \mathbf{M}). \quad (3.23)$$

Maxwell's equations also tell us that

$$\nabla \cdot \mathbf{B} = 0. \quad (3.24)$$

<sup>5</sup>Properly the name “magnetic field” is applied to  $\mathbf{H}$  in a magnetic medium. Then the field  $\mathbf{B}$  is called the magnetic induction or the magnetic flux density. Many people find this terminology confusing. Following Blundell (2001), in this book we shall simply call them the “H-field” and “B-field,” respectively, whenever there is a need to distinguish between them.

# Superconducting phenomenology

To see how this persistent current can be set up, consider the flux of magnetic field through the center of the superconducting ring. The flux is defined by the surface integral

$$\Phi = \int \mathbf{B} \cdot d\mathbf{S} \quad (3.14)$$

where  $d\mathbf{S}$  is a vector perpendicular to the plane of the ring. Its length  $dS$ , is an infinitesimal element of the area enclosed by the ring. But, by using the Maxwell equation

$$\nabla \times \mathbf{E} = -\frac{\partial \mathbf{B}}{\partial t} \quad (3.15)$$

and Stokes's theorem

$$\int (\nabla \times \mathbf{E}) d\mathbf{S} = \oint \mathbf{E} \cdot d\mathbf{r} \quad (3.16)$$

we can see that

$$-\frac{d\Phi}{dt} = \oint \mathbf{E} \cdot d\mathbf{r} \quad (3.17)$$

where the line integral is taken around the closed path around the inside of the ring. This path can be taken to be just inside the superconductor, and so  $\mathbf{E} = 0$  everywhere along the path. Therefore

$$\frac{d\Phi}{dt} = 0 \quad (3.18)$$

and hence the magnetic flux through the ring stays constant as a function of time.

We can use this property to set up a persistent current in a superconducting ring. First we start with the superconductor at

a temperature above  $T_c$ , so that it is in its normal state. Then apply an external magnetic field,  $\mathbf{B}_{\text{ext}}$ . This passes easily through the superconductor since the system is normal. Now cool the system to below  $T_c$ . The flux in the ring is given by  $\Phi = \int \mathbf{B}_{\text{ext}} \cdot d\mathbf{S}$ . But we know from Eq. 3.18 that this remains constant, no matter what. It is constant even if we turn off the source of external magnetic field, so that now  $\mathbf{B}_{\text{ext}} = 0$ . The only way the superconductor can keep  $\Phi$  constant is to generate its own magnetic field  $\mathbf{B}$  through the center of the ring, which it must achieve by having a circulating current,  $I$ , around the ring. The value of  $I$  will be exactly the one required to induce a magnetic flux equal to  $\Phi$  inside the ring. Further, because  $\Phi$  is constant the current  $I$  must also be constant. We therefore have a set up circulating persistent current in our superconducting ring.

Furthermore if there were any electrical resistance at all in the ring there would be energy dissipation and hence the current  $I$  would decay gradually over time. But experiments have been done in which persistent currents were observed to remain constant over a period of years. Therefore the resistance must really be exactly equal to zero to all intents and purposes!

# Superconducting phenomenology

## The Meissner–Ochsenfeld effect

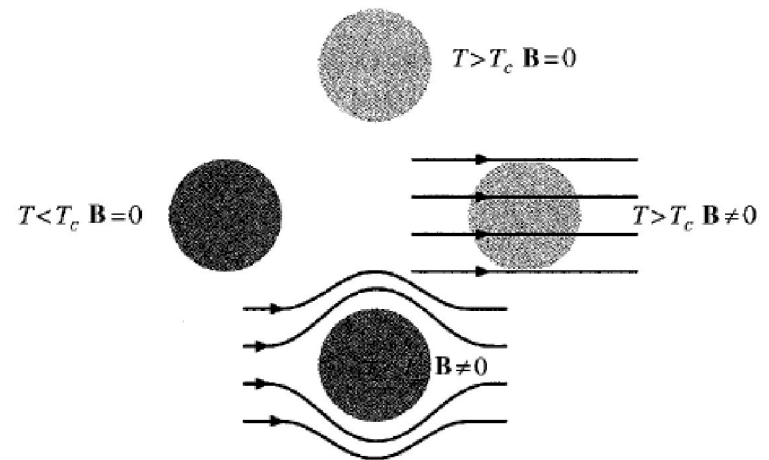
Nowadays, the fact that the resistivity is zero,  $\rho = 0$ , is not taken as the true definition of superconductivity. The fundamental proof that superconductivity occurs in a given material is the demonstration of the Meissner–Ochsenfeld effect.

This effect is the fact that a superconductor **expels** a weak external magnetic field. First, consider the situation illustrated in Fig. 3.5 in which a small spherical sample of material is held at temperature  $T$  and placed in a small external magnetic field,  $\mathbf{B}_{\text{ext}}$ . Suppose initially we have the sample in its normal state,  $T > T_c$ , and the external field is zero, as illustrated in the top part of the diagram in Fig. 3.5. Imagine that we first cool to a temperature below  $T_c$  (left diagram) while keeping the field zero. Then later as we gradually turn on the external field the field inside the sample must remain zero (bottom diagram). This is because, by the Maxwell equation Eq. 3.15 combined with  $\mathbf{e} = 0$  we must have

$$\frac{\partial \mathbf{B}}{\partial t} = 0 \quad (3.19)$$

at all points inside the superconductor. Thus by applying the external field to the sample after it is already superconducting we must arrive at the state shown in the bottom diagram in Fig. 3.5 where the magnetic field  $\mathbf{B} = 0$  is zero everywhere inside the sample.

But now consider doing things in the other order. Suppose we take the sample above  $T_c$  and first turn on the external field,  $\mathbf{B}_{\text{ext}}$ . In this case the magnetic field will easily penetrate into the sample,  $\mathbf{B} = \mathbf{B}_{\text{ext}}$ , as shown in the right hand picture in Fig. 3.5. What happens then we now cool the sample? The Meissner–Ochsenfeld effect is the observation that upon cooling the system to below  $T_c$  the magnetic field is **expelled**. So that by cooling we move from the situation depicted on right to the one shown at the bottom of Fig. 3.5. This fact cannot be deduced from the simple fact of zero resistivity ( $\rho = 0$ ) and so this is a new and separate physical phenomenon associated with superconductors.



# Superconducting phenomenology

## Perfect diamagnetism

In order to maintain  $\mathbf{B} = 0$  inside the sample whatever (small) external fields are imposed as required by the Meissner–Ochsenfeld effect there obviously must be screening currents flowing around the edges of the sample. These produce a magnetic field which is equal and opposite to the applied external field, leaving zero field in total.

The total current is separated into the externally applied currents (e.g. in the coils producing the external field),  $\mathbf{j}_{\text{ext}}$ , and the internal screening currents,  $\mathbf{j}_{\text{int}}$ ,

$$\mathbf{j} = \mathbf{j}_{\text{ext}} + \mathbf{j}_{\text{int}}. \quad (3.20)$$

The screening currents produce a magnetization in the sample,  $\mathbf{M}$  per unit volume, defined by

$$\nabla \times \mathbf{M} = \mathbf{j}_{\text{int}}. \quad (3.21)$$

We define the magnetic field  $\mathbf{H}$  in terms of the external currents only

$$\nabla \times \mathbf{H} = \mathbf{j}_{\text{ext}}. \quad (3.22)$$

The three vectors  $\mathbf{M}$  and  $\mathbf{H}$  and  $\mathbf{B}$  are related by<sup>5</sup>

$$\mathbf{B} = \mu_0(\mathbf{H} + \mathbf{M}). \quad (3.23)$$

Maxwell's equations also tell us that

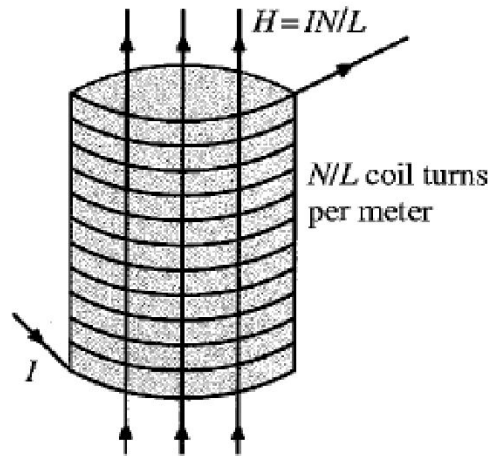
$$\nabla \cdot \mathbf{B} = 0. \quad (3.24)$$

The magnetic medium Maxwell's equations above are supplemented by boundary conditions at the sample surface. From Eq. 3.24 it follows that the component of  $\mathbf{B}$  perpendicular to the surface must remain constant; while from the condition Eq. 3.22 one can prove that components of  $\mathbf{H}$  parallel to the surface remain constant. The two boundary conditions are therefore,

$$\Delta \mathbf{B}_{\perp} = 0, \quad (3.25)$$

$$\Delta \mathbf{H}_{\parallel} = 0. \quad (3.26)$$

# Superconducting phenomenology



**Fig. 3.6** Measurement of  $\mathbf{M}$  as a function of  $\mathbf{H}$  for a sample with solenoidal geometry. A long solenoid coil of  $N/L$  turns per metre leads to a uniform field  $H = IN/L$  Amperes per metre inside the solenoid. The sample has magnetization,  $M$ , inside the solenoid, and the magnetic flux density is  $B = \mu_0(H + M)$ . Increasing the current in the coils from  $I$  to  $I + dI$ , by  $dI$  leads to an inductive e.m.f.  $\mathcal{E} = -d\Phi/dt$  where  $\Phi = NBA$  is the total magnetic flux threading the  $N$  current turns of area  $A$ . This inductive e.m.f. can be measured directly, since it is simply related to the differential self-inductance of the coil,  $\mathcal{L}$ , via  $\mathcal{E} = -\mathcal{L}dI/dt$ . Therefore, by measuring the self-inductance  $\mathcal{L}$  one can deduce the  $B$ -field and hence  $M$  as a function of  $I$  or  $H$ .

For simplicity we shall usually assume that the sample is an infinitely long solenoid as sketched in Fig. 3.6. The external current flows in solenoid coils around the sample. In this case the field  $\mathbf{H}$  is uniform inside the sample,

$$\mathbf{H} = I \frac{N}{L} \mathbf{e}_z \quad (3.27)$$

where  $I$  is the current flowing through the solenoid coil and there are  $N$  coil turns in length  $L$ .  $\mathbf{e}_z$  is a unit vector along the solenoid axis.

Imposing the Meissner condition  $\mathbf{B} = 0$  in Eq. 3.23 immediately leads to the magnetization

$$\mathbf{M} = -\mathbf{H}. \quad (3.28)$$

The magnetic susceptibility is defined by

$$\chi = \left. \frac{dM}{dH} \right|_{H=0} \quad (3.29)$$

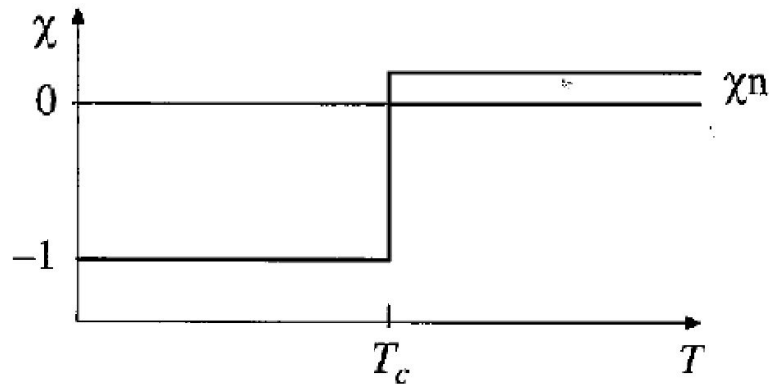
and so we find that for superconductors

$$\chi = -1 \quad (3.30)$$

(or  $-1/4\pi$  in cgs units!).

Solids with a negative value of  $\chi$  are called diamagnets (in contrast positive  $\chi$  is a paramagnet). Diamagnets screen out part of the external magnetic field, and so they become magnetized oppositely to the external field. In superconductors the external field is completely screened out. Therefore we can say that superconductors are **perfect diamagnets**.

# Superconducting phenomenology



**Fig. 3.7** Magnetic susceptibility,  $\chi$ , of a superconductor as a function of temperature. Above  $T_c$  it is a constant normal state value,  $\chi_n$ , which is usually small and positive (paramagnetic). Below  $T_c$  the susceptibility is large and negative,  $\chi = -1$ , signifying perfect diamagnetism.

**Fig. 3.8** The magnetization  $M$  as a function of  $H$  in type I and type II superconductors. For type I perfect Meissner diamagnetism is continued until  $H_c$ , beyond which superconductivity is destroyed. For type II materials perfect diamagnetism occurs only below  $H_{c1}$ . Between  $H_{c1}$  and  $H_{c2}$  Abrikosov vortices enter the material, which is still superconducting.

This susceptibility  $\chi$  is defined in the limit of very weak external fields,  $\mathbf{H}$ . As the field becomes stronger it turns out that either one of two possible things can happen.

The first case, called a **type I superconductor**, is that the  $\mathbf{B}$  field remains zero inside the superconductor until suddenly the superconductivity is destroyed. The field where this happens is called the **critical field**,  $H_c$ . The way the magnetization  $M$  changes with  $H$  in a type I superconductor is shown in Fig. 3.8. As shown, the magnetization obeys  $M = -H$  for all fields less than  $H_c$ , and then becomes zero (or very close to zero) for fields above  $H_c$ .

# Creators of the type II superconductors



▼ L.V. Shubnikov



A. A. Abrikosov

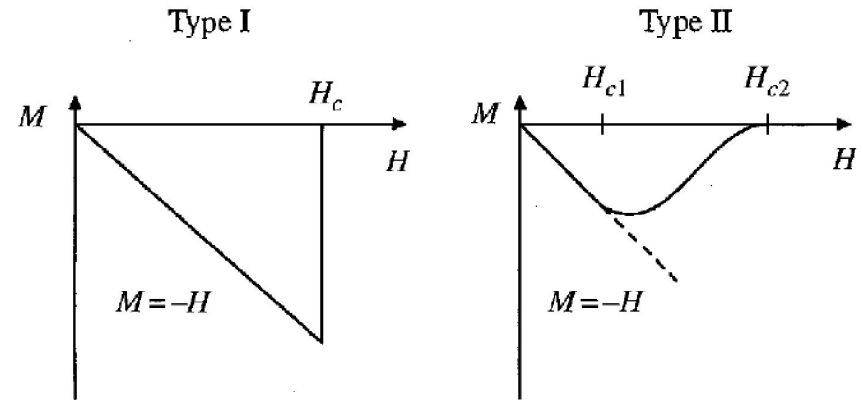


# Superconducting phenomenology

Many superconductors, however, behave differently. In a **type II superconductor** there are two different critical fields, denoted  $H_{c1}$ , the **lower critical field**, and  $H_{c2}$  the **upper critical field**. For small values of applied field  $H$  the Meissner–Ochsenfeld effect again leads to  $M = -H$  and there is no magnetic flux inside the sample,  $B = 0$ . However, in a type II superconductor once the field exceeds  $H_{c1}$ , magnetic flux does start to enter the superconductor and hence  $B \neq 0$ , and  $M$  is closer to zero than the full Meissner–Ochsenfeld value of  $-H$ . Upon increasing the field  $H$  further the magnetic flux density gradually increases, until finally at  $H_{c2}$  the superconductivity is destroyed and  $M = 0$ . This behavior is sketched on the right-hand-side of Fig. 3.8.

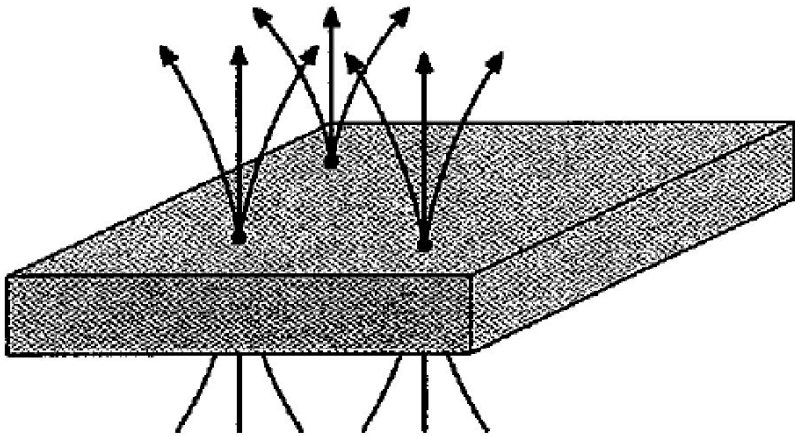
The physical explanation of the thermodynamic phase between  $H_{c1}$  and  $H_{c2}$  was given by Abrikosov. He showed that the magnetic field can enter the superconductor in the form of **vortices**, as shown in Fig. 3.10. Each vortex consists of a region of circulating supercurrent around a small central core which has essentially become normal metal.

The magnetic field is able to pass through the sample inside the vortex cores, and the circulating currents serve to screen out the magnetic field from the rest of the superconductor outside the vortex.



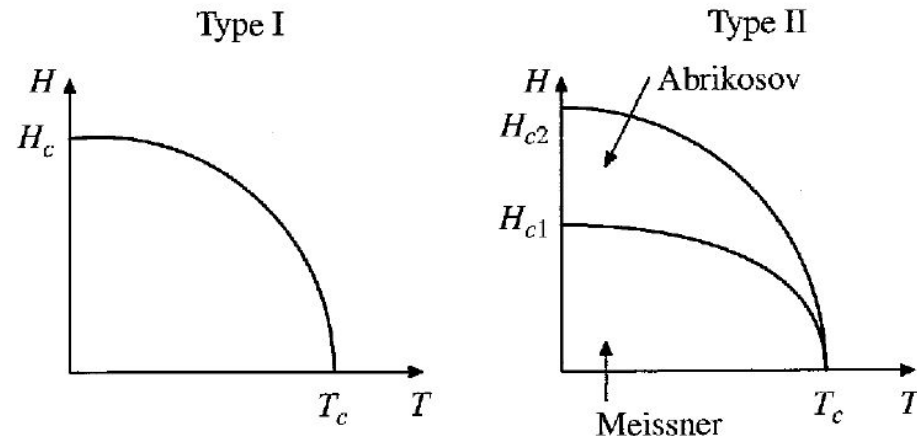
**Fig. 3.8** The magnetization  $M$  as a function of  $H$  in type I and type II superconductors. For type I perfect Meissner diamagnetism is continued until  $H_c$ , beyond which superconductivity is destroyed. For type II materials perfect diamagnetism occurs only below  $H_{c1}$ . Between  $H_{c1}$  and  $H_{c2}$  Abrikosov vortices enter the material, which is still superconducting.

# Superconducting phenomenology



**Fig. 3.9** The  $H-T$  phase diagram of type I and type II superconductors. In type II superconductors the phase below  $H_{c1}$  is normally denoted the Meissner state, while the phase between  $H_{c1}$  and  $H_{c2}$  is the Abrikosov or mixed state.

**Fig. 3.10** Vortices in a type II superconductor. The magnetic field can pass through the superconductor, provided it is channelled through a small “vortex core.” The vortex core is normal metal. This allows the bulk of the material to remain superconducting, while also allowing a finite average magnetic flux density  $B$  to pass through.



It turns out that each vortex carries a fixed unit of magnetic flux,  $\Phi_0 = h/2e$

# Superconducting phenomenology: London equation

The first theory which could account for the existence of the Meissner-Ochsenfeld effect was developed by two brothers, F. London and H. London, in 1935. Their theory was originally motivated by the two-fluid model of superfluid  $^4\text{He}$ . They assumed that some fraction of the conduction electrons in the solid become superfluid while the rest remain normal. They then assumed that the superconducting electrons could move without dissipation, while the normal electrons would continue to act as if they had a finite resistivity. Of course the superfluid electrons always “short circuit” the normal ones and make the overall resistivity equal to zero.

We denote the number density of superfluid electrons by  $n_s$  and the density of normal electrons by  $n_n = n - n_s$ , where  $n$  is the total density of electrons per unit volume.

This model leads to the famous London equation

$$\mathbf{j} = -\frac{n_s e^2}{m_e} \mathbf{A}. \quad (3.33)$$

Here,  $\mathbf{j}$  is the electrical current density inside the superconductor, whereas  $\mathbf{A}$  is the magnetic vector potential.

This is one of the most important equations describing superconductors. Nearly 20 years after it was originally introduced by the London brothers it was eventually derived from the full microscopic quantum theory of superconductivity by Bardeen Cooper and Schrieffer.

Let us start to make the London equation Eq. 3.33 plausible by reexamining the Drude model of conductivity. This time consider the Drude theory for finite frequency electric fields. Using the complex number representation of the a.c. currents and fields, the d.c. formula becomes modified to:

$$\mathbf{j}e^{-i\omega t} = \sigma(\omega)\boldsymbol{\mathcal{E}}e^{-i\omega t} \quad (3.34)$$

where the conductivity is also complex. Its real part corresponds to currents which are in phase with the applied electrical field (resistive), while the imaginary part corresponds to out of phase currents (inductive and capacitive).

Generalizing the Drude theory to the case of finite frequency, the conductivity turns out to be

$$\sigma(\omega) = \frac{ne^2\tau}{m} \frac{1}{1 - i\omega\tau}, \quad (3.35)$$

Ashcroft and Mermin (1976). This is essentially like the response of a damped harmonic oscillator with a resonant frequency at  $\omega = 0$ . Taking the real part we get

$$\text{Re}[\sigma(\omega)] = \frac{ne^2}{m} \frac{\tau}{1 + \omega^2\tau^2}, \quad (3.36)$$

a Lorentzian function of frequency. Note that the width of the Lorentzian is  $1/\tau$  and its maximum height is  $\tau$ . Integrating over frequency, we see that the area under this Lorentzian curve is a constant

$$\int_{-\infty}^{+\infty} \text{Re}[\sigma(\omega)]d\omega = \frac{\pi ne^2}{m} \quad (3.37)$$

independent of the lifetime  $\tau$ .

# Superconducting phenomenology: London equation

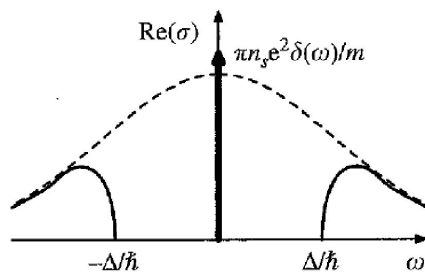
Now it is interesting to consider what would be the corresponding Drude model  $\sigma(\omega)$  in the case of a perfect conductor, where there is no scattering of the electrons. We can obtain this by taking the limit  $\tau^{-1} \rightarrow 0$  in the Drude model. Taking this limit Eq. 3.35 gives:

$$\sigma(\omega) = \frac{ne^2}{m} \frac{1}{\tau^{-1} - i\omega} \rightarrow -\frac{ne^2}{i\omega m} \quad (3.38)$$

at any finite frequency,  $\omega$ . There is no dissipation since the current is always out of phase with the applied electric field and  $\sigma(\omega)$  is always imaginary. There is a purely inductive response to an applied electric field. The real part of the conductivity  $\text{Re}[\sigma(\omega)]$  is therefore zero at any finite frequency,  $\omega$  in this  $\tau^{-1} \rightarrow 0$  limit. But the sum rule, Eq. 3.37, must be obeyed whatever the value of  $\tau$ . Therefore the real part of the conductivity,  $\text{Re}[\sigma(\omega)]$  must be a function which is zero almost everywhere but which has a finite integral. This must be, of course, a Dirac delta function,

$$\text{Re}[\sigma(\omega)] = \frac{\pi ne^2}{m} \delta(\omega). \quad (3.39)$$

One can see that this is correct by considering the  $\tau^{-1} \rightarrow 0$  limit of the Lorentzian peak in  $\text{Re}[\sigma(\omega)]$  in Eq. 3.36. The width of the peak is of order  $\tau^{-1}$  and goes to zero, but the maximum height increases keeping a constant



**Fig. 3.11** The finite frequency conductivity of a normal metal (dashed line) and a superconductor (solid line). In the superconducting case an energy gap leads to zero conductivity for frequencies below  $\Delta/\hbar$ . The remaining spectral weight becomes concentrated in a Dirac delta function at  $\omega = 0$ .

total area because of the sum rule. The  $\tau^{-1}$  goes to zero limit is thus a Dirac delta function located at  $\omega = 0$ .

Inspired by the two fluid model of superfluid  $^4\text{He}$ , the London brothers assumed that we can divide the total electron density,  $n$ , into a normal part,  $n_n$  and a superfluid part,  $n_s$ ,

$$n = n_s + n_n. \quad (3.40)$$

They assumed that the “normal” electrons would still have a typical metallic damping time  $\tau$ , but the superfluid electrons would move without dissipation, corresponding to  $\tau = \infty$ . They assumed that this superfluid component will give rise to a Dirac delta function peak in the conductivity located at  $\omega = 0$  and a purely imaginary response elsewhere,

$$\sigma(\omega) = \frac{\pi n_s e^2}{m_e} \delta(\omega) - \frac{n_n e^2}{i\omega m_e}. \quad (3.41)$$

Note that we effectively **define**  $n_s$  by the weight in this delta function peak, and (by convention) we use the bare electron mass in vacuum,  $m_e$ , rather than the effective band mass,  $m$ , in this definition.

In fact the experimentally measured finite frequency conductivity  $\text{Re} \sigma(\omega)$  in superconductors does indeed have a delta function located at zero frequency. But other aspects of the two fluid model conductivity assumed by London and London are not correct. In particular the “normal” fluid component is not simply like the conductivity of a normal metal. In fact the complete  $\text{Re}[\sigma(\omega)]$  of a superconductor looks something like the sketch in Fig. 3.11. There is a delta function peak located at  $\omega = 0$ , and the amplitude of the peak defines  $n_s$ , the superfluid density or condensate density. At higher frequencies the real part of the conductivity is zero,  $\text{Re}[\sigma(\omega)] = 0$ , corresponding to dissipationless current flow. However, above a certain frequency, corresponding to  $\hbar\omega = 2\Delta$  (where  $2\Delta$  is the “energy gap”) the conductivity again becomes finite. The presence of an energy gap was observed shortly before the Bardeen Cooper and Schrieffer (BCS) theory was completed, and the energy gap was a central feature of the theory, as we shall see later.

# Superconducting phenomenology: London equation

Let us consider the second Newton law  $m d\mathbf{v}/dt = e\mathbf{E}$ . This equations means that there is no resistance! (The main point! – infinite conductivity).

The current density  $\mathbf{j} = n_s e\mathbf{v}$ .

Then  $d(\Lambda\mathbf{j})/dt = \mathbf{E}$  (\*),

where

$$\Lambda = m/(n_s e^2).$$

One knows that the full and partial time derivative are connected by the equation

$$d/dt = \partial/\partial t + \mathbf{v}\nabla.$$

Since real current velocities  $\mathbf{v}$  in metals are small in comparison with the Fermi velocity  $v_F$ , one can replace the full derivative by the partial one. Then

$$\partial(\Lambda\mathbf{j})/\partial t = \mathbf{E} \text{ (}^\dagger\text{)}.$$

We have the Maxwell equation (Faraday electromagnetic induction equation):

$$\text{rot } \mathbf{E} = -c^{-1}\partial\mathbf{H}/\partial t \text{ (**)}.$$

Let us apply a rotor operation to the equation (†). Then

$$\partial(\Lambda \text{ rot } \mathbf{j})/\partial t = \text{rot } \mathbf{E} \text{ (***)}.$$

# Superconducting phenomenology: London equation

From (\*\*) and (\*\*\*) one obtains

$$\partial(A \operatorname{rot} \mathbf{j})/\partial t = -c^{-1} \partial \mathbf{H} / \partial t \quad (***) . \text{ Or}$$

$$\partial/\partial t (\operatorname{rot} A \mathbf{j} + c^{-1} \mathbf{H}) = 0 \quad (***) .$$

It means that the quantity in the parentheses of Eq. (\*\*\*\*) is conserved in time.

Now, it is another main step, that takes into account the superconductivity itself! Specifically, in the bulk of the superconductor both

$$\mathbf{j} = 0$$

And

$$\mathbf{H} = 0 .$$

It simply reflects the Meissner effect!

Then

$$\operatorname{rot} A \mathbf{j} + c^{-1} \mathbf{H} = 0 \quad (****) .$$

Equations (\*\*\*\*) and (i) constitute the basis of the London theory.

# Superconducting phenomenology: London equation

Equation (\*\*\*\*) and the Maxwell equation

$$\text{rot } \mathbf{H} = 4\pi\mathbf{j}/c$$

leads to the characteristic result of London electrodynamics. Below, we shall write relevant equations in the SI unit system.

This equation completely determines  $\mathbf{j}$  and  $\mathbf{B}$  because they are also related by the static Maxwell equation:

$$\nabla \times \mathbf{B} = \mu_0\mathbf{j}. \quad (3.44)$$

Combining these two equations gives

$$\nabla \times (\nabla \times \mathbf{B}) = -\mu_0 \frac{n_s e^2}{m_e} \mathbf{B} \quad (3.45)$$

or

$$\nabla \times (\nabla \times \mathbf{B}) = -\frac{1}{\lambda^2} \mathbf{B}, \quad (3.46)$$

where  $\lambda$  has dimensions of length, and is the **penetration depth** of the superconductor,

$$\lambda = \left( \frac{m_e}{\mu_0 n_s e^2} \right)^{1/2}. \quad (3.47)$$

It is the distance inside the surface over which an external magnetic field is screened out to zero, given that  $B = 0$  in the bulk.

In the CGS unit system  $\lambda = (mc^2/4\pi n_s e^2)^{1/2}$ .

# Superconducting phenomenology: London equation

Finally, the London equation can also be rewritten in terms of the magnetic vector potential  $\mathbf{A}$  defined by

$$\mathbf{B} = \nabla \times \mathbf{A}, \quad (3.48)$$

From (3.48) and Eq. (\*\*\*\*\*) one obtains

$$\mathbf{j} = -\frac{n_s e^2}{m_e} \mathbf{A}, \quad (3.49)$$

$$= -\frac{1}{\mu_0 \lambda^2} \mathbf{A}. \quad (3.50)$$

Note that this only works provided that we choose the correct **gauge** for the vector potential,  $\mathbf{A}$ . Recall that  $\mathbf{A}$  is not uniquely defined from Eq. 3.48 since  $\mathbf{A} + \nabla \chi(\mathbf{r})$  leads to exactly the same  $\mathbf{B}$  for any scalar function,  $\chi(\mathbf{r})$ . But conservation of charge implies that the current and charge density,  $\rho$ , obey the continuity equation

$$\frac{\partial \rho}{\partial t} + \nabla \cdot \mathbf{j} = 0. \quad (3.51)$$

In a static, d.c., situation the first term is zero, and so  $\nabla \cdot \mathbf{j} = 0$ . Comparing with the London equation in the form, Eq. 3.49 we see that this is satisfied provided that the gauge is chosen so that  $\nabla \cdot \mathbf{A} = 0$ . This is called the **London gauge**.



# Superconducting phenomenology: London equation

For superconductors this form of the London equation effectively replaces the normal metal  $\mathbf{j} = \sigma \mathbf{E}$  constitutive relation by something which is useful when  $\sigma$  is infinite.

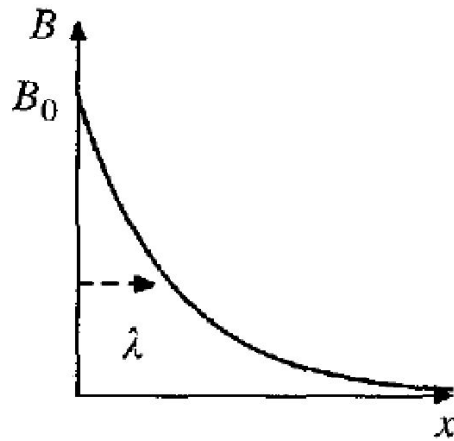
We saw that the suggestions  $\mathbf{j} = 0$  and  $\mathbf{H} = 0$  in the bulk of superconductors already describes the Meissner effect. Still, some people think that London equations explain the Meissner effect. I do not think so.

The most important consequence of the London equation is to explain the Meissner–Ochsenfeld effect. In fact one can easily show that any external magnetic field is screened out inside the superconductor, as

$$B = B_0 e^{-x/\lambda}, \quad (3.52)$$

where  $x$  is the depth inside the surface of the superconductor. This is illustrated in Fig. 3.12. The derivation of this expression from the London equation is very straightforward

# Superconducting phenomenology: London equation



**Fig. 3.12** The magnetic field near a surface of a superconductor in the Meissner state. The field decays exponentially on a length scale given by the penetration depth  $\lambda$ .

Eq. (3.46) can be transformed and solved to obtain Eq. (3.52). Namely, one knows the vector identity  $\text{rot rot } \mathbf{B} = \nabla \text{ div } \mathbf{B} - \Delta \mathbf{B}$ , where  $\mathbf{B}$  is an arbitrary vector. However,  $\text{div } \mathbf{B} = 0$ , because there are no magnetic charges. Therefore,  $\Delta \mathbf{B} = \mathbf{B}/\lambda^2$ . Now, for the special geometry of Fig. 3.12 one has

In Fig. 3.12, the surface of the superconductor lies in the  $y$ - $z$  plane. A magnetic field is applied in the  $z$  direction parallel to the surface,  $\mathbf{B} = (0, 0, B_0)$ . Given that inside the superconductor the magnetic field is a function of  $x$  only,  $\mathbf{B} = (0, 0, B_z(x))$  show that

$$\frac{d^2 B_z(x)}{dx^2} = \frac{1}{\lambda^2} B_z(x).$$

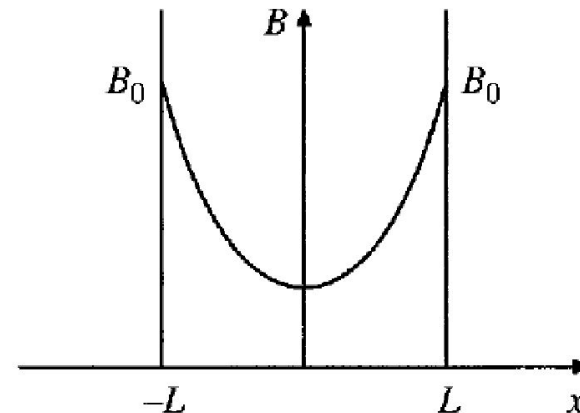
# Superconducting phenomenology: London equation

Solving the ordinary differential equation in (b) show that the magnetic field near a surface of a superconductor has the form

$$B = B_0 \exp(-x/\lambda)$$

Consider a thin superconducting slab, of thickness  $2L$ , as shown in Fig. 3.13. If an external parallel magnetic field,  $B_0$ , is applied parallel to the slab surfaces, show that inside the slab the magnetic field becomes

$$B_z(x) = B_0 \frac{\cosh(x/\lambda)}{\cosh(L/\lambda)}.$$



**Fig. 3.13** Exercise 3.2: the magnetic field inside a superconducting slab of thickness  $2L$ .

# Superconducting phenomenology: London-Pippard equation

A modified form of the London equation was later proposed by Pippard. This form generalizes the London equation by relating the current at a point  $\mathbf{r}$  in the solid,  $\mathbf{j}(\mathbf{r})$ , to the vector potential at nearby points  $\mathbf{r}'$ . The expression he proposed was

$$\mathbf{j}(\mathbf{r}) = -\frac{n_s e^2}{m_e} \frac{3}{4\pi \xi_0} \int \frac{\mathbf{R}(\mathbf{R} \cdot \mathbf{A}(\mathbf{r}'))}{R^4} e^{-R/r_0} d^3 r', \quad (3.53)$$

where  $\mathbf{R} = \mathbf{r} - \mathbf{r}'$ . The points which contribute to the integral are separated by distances of order  $r_0$  or less, with  $r_0$  defined by

$$\frac{1}{r_0} = \frac{1}{\xi_0} + \frac{1}{l}. \quad (3.54)$$

Here  $l$  is the **mean free path** of the electrons at the Fermi surface of the metal,

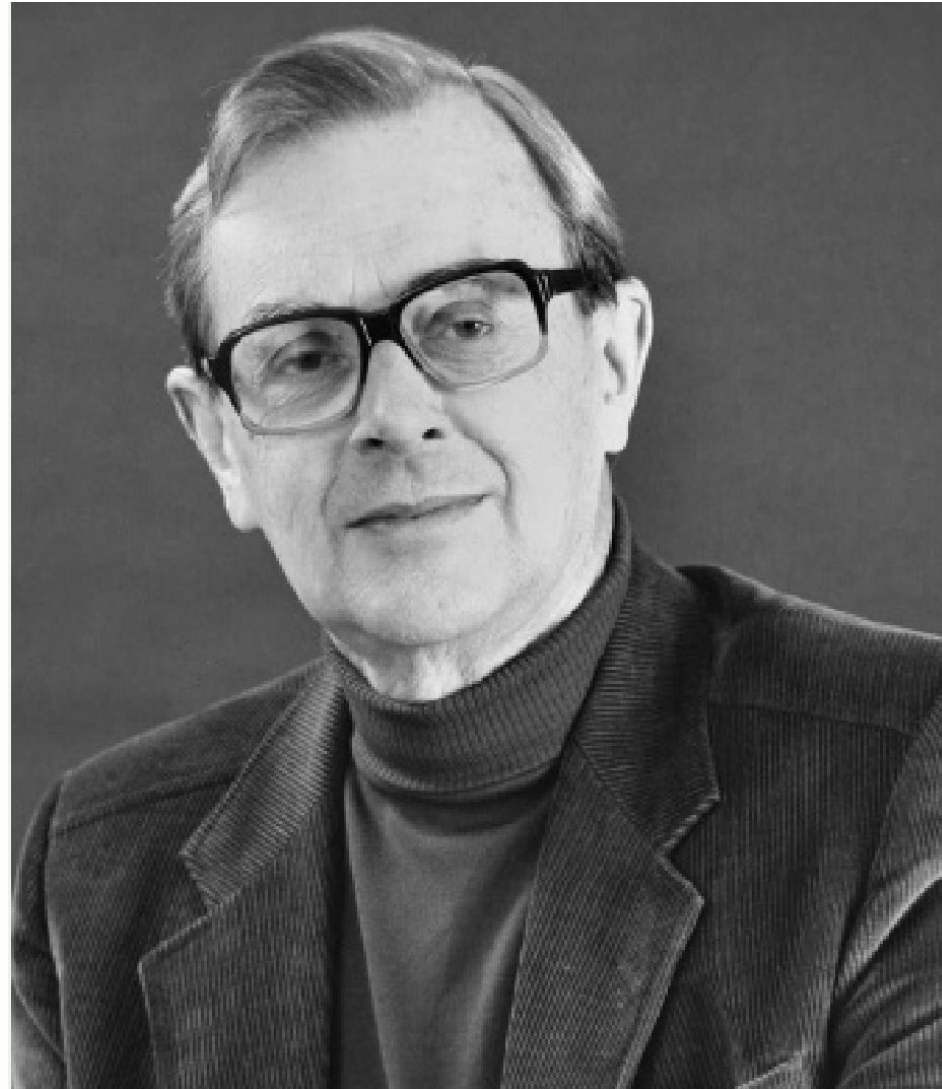
$$l = v_F \tau, \quad (3.55)$$

with  $\tau$  the scattering time from the Drude conductivity formula, and  $v_F$  the electron band velocity at the Fermi surface. The length  $\xi_0$  is called the **coherence length**. After the BCS theory of superconductivity was completed, it became clear that this length is closely related to the value of the energy gap,  $\Delta$ , by

$$\xi_0 = \frac{\hbar v_F}{\pi \Delta}. \quad (3.56)$$

It also has the physical interpretation that it represents the physical size of the Cooper pair bound state in the BCS theory.

# Brian Pippard (1920-2008)



# Superconducting phenomenology: London-Pippard equation

The existence of the Pippard coherence length implies that a superconductor is characterized by no fewer than **three different length scales**. We have the penetration depth,  $\lambda$ , the coherence length,  $\xi_0$ , and the mean free path,  $l$ . We shall see in the next chapter that the dimensionless ratio  $\kappa = \lambda/\xi_0$  determines whether a superconductor is type I or type II. Similarly, if the mean free path is much longer than the coherence length,  $l \gg \xi_0$  the superconductor is said to be in the **clean limit**, while if  $l < \xi_0$  the superconductor is said to be in the **dirty limit**. It is a surprising and very important property of most superconductors that they can remain superconducting even when there are large numbers of impurities making the mean free path  $l$  very short. In fact even many alloys are superconducting despite the strongly disordered atomic structure.

# Superconductors of the first and second kind

For typical pure superconductors  $\lambda < \xi$  and this was the reason for a positive surface energy associated with a normal superconducting boundary. Roughly speaking, one loses an energy  $\xi H_c^2/8\pi$  for the variation of  $\psi$  from its superconducting value to zero while one gains  $\lambda H_c^2/8\pi$  in reducing the magnetic energy, thus

$$\sigma_n \simeq (\xi - \lambda) \frac{H_c^2}{8\pi}.$$

Abrikosov investigated what would happen if  $\kappa$  were large, that is,  $\xi < \lambda$ . This leads to a negative surface energy which tends to subdivide the material into domains characterized by the length  $\xi$ . He called these materials type II superconductors and showed that the exact critical value for negative surface energy is  $\kappa = \sqrt{1/2}$ . For these materials there is a continuous increase in flux penetration, starting at a first critical field  $H_{c1}$  and reaching  $B = H$  at a second critical field  $H_{c2}$ , where the material becomes normal (figure 3). Because of this partial flux penetration the energy of holding the field out is less and  $H_{c2}$  is greater than  $H_c$

$$H_{c2} = \kappa H_c \sqrt{2}.$$

# Superconductors of the first and second kind

Abrikosov showed that the flux penetrates in a regular array of flux tubes or vortices each carrying a quantum of flux (figure 4)

$$\phi_0 = \frac{hc}{2e} = 2 \times 10^{-7} \text{ G cm}^2.$$

These type II superconductors are now known to be the more common in nature (any type I material when alloyed becomes type II) and are used more in applications of superconductors. Much of the following work is devoted to these materials.

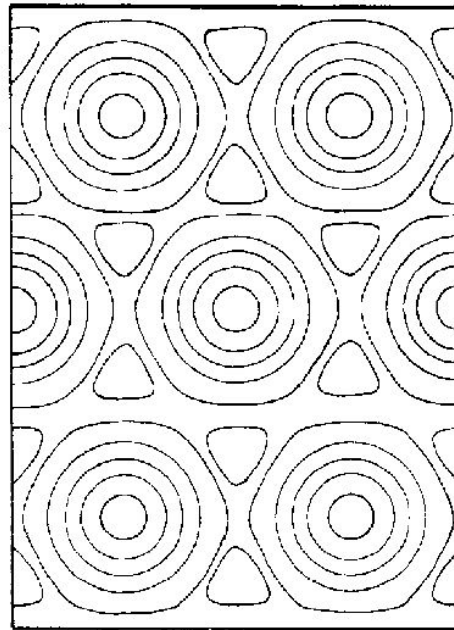


Figure 4. The Abrikosov array of flux lines.



# The London vortex

We can use the London equation to find a simple mathematical description of a superconducting vortex, as in Fig. 3.10. The vortex will have a cylindrical core

of normal material, with a radius of approximately the coherence length,  $\xi_0$ . Inside this core we will have a finite magnetic field, say  $B_0$ . Outside the vortex core we can use the London equation in the form of Eq. 3.46 to write a differential equation for the magnetic field,  $\mathbf{B} = (0, 0, B_z)$ . Using cylindrical polar coordinates  $(r, \theta, z)$ , and the expression for curl in cylindrical polars, Eq. 2.43, we obtain (Exercise 3.3)

$$\frac{d^2 B_z}{dr^2} + \frac{1}{r} \frac{dB_z}{dr} - \frac{B_z}{\lambda^2} = 0. \quad (3.57)$$

This is a form of Bessel's equation (Boas 1983; Matthews and Walker 1970). The solutions to equations of this type are called modified, or hyperbolic Bessel functions,  $K_\nu(z)$  and they can be found in many standard texts of mathematical physics. In this particular case the solution is  $K_0(z)$ . The resulting magnetic field can be written in the form,

$$B_z(r) = \frac{\Phi_0}{2\pi\lambda^2} K_0\left(\frac{r}{\lambda}\right), \quad (3.58)$$

where  $\Phi_0$  is the total magnetic flux enclosed by the vortex core,

$$\Phi_0 = \int B_z(r) d^2r. \quad (3.59)$$

We shall see in the next chapter that the magnetic flux is quantized, resulting in the universal value  $\Phi_0 = h/2e$  of flux per vortex line.

For small values of  $z$  the function  $K_0(z)$  becomes

$$K_0(z) \sim -\ln z$$

(Abramowitz and Stegun 1965) and so

$$B_z(r) = \frac{\Phi_0}{2\pi\lambda^2} \ln\left(\frac{\lambda}{r}\right), \quad (3.60)$$

when  $r \ll \lambda$ .