



PDP Training Manual



p450

Agenda

1. P450 Training
2. Disassembly
3. Trouble shooting
4. Appendix
 - . PC Timming
 - . 3D Function

1. PB450 Training

● Comparison with other Models

Project	PB450 (U1P)	PYROPE (W3)
Design		
Brightness	1500cd/m ²	1500cd/m ²
Contrast ratio	15000:1	15000:1
Tuner	1 Nim Tuner (Slim)	1 Nim Tuner (Slim)
Audio out	10W x 2	10W x 2
Sound	SRS Tru Surround XT	SRS Tru Surround XT
Speaker	Included	Included
Video input	1Side	1Side
S-Video input	X	1Side
Component Input	1Rear	1Rear
Side Input	CVBS, HDMI	CVBS,S-Video, Headphone, HDMI
HDMI	2Rear + 1Side	2Rear + 1Side
Power Consumption	42" : 350W 50" : 450W	42" : 380W 50" : 480W
Etc.	-	-

- Picture of PS50B450 Set [Back view]



- **Picture of P450 42" U1P PDP Module [Back view]**

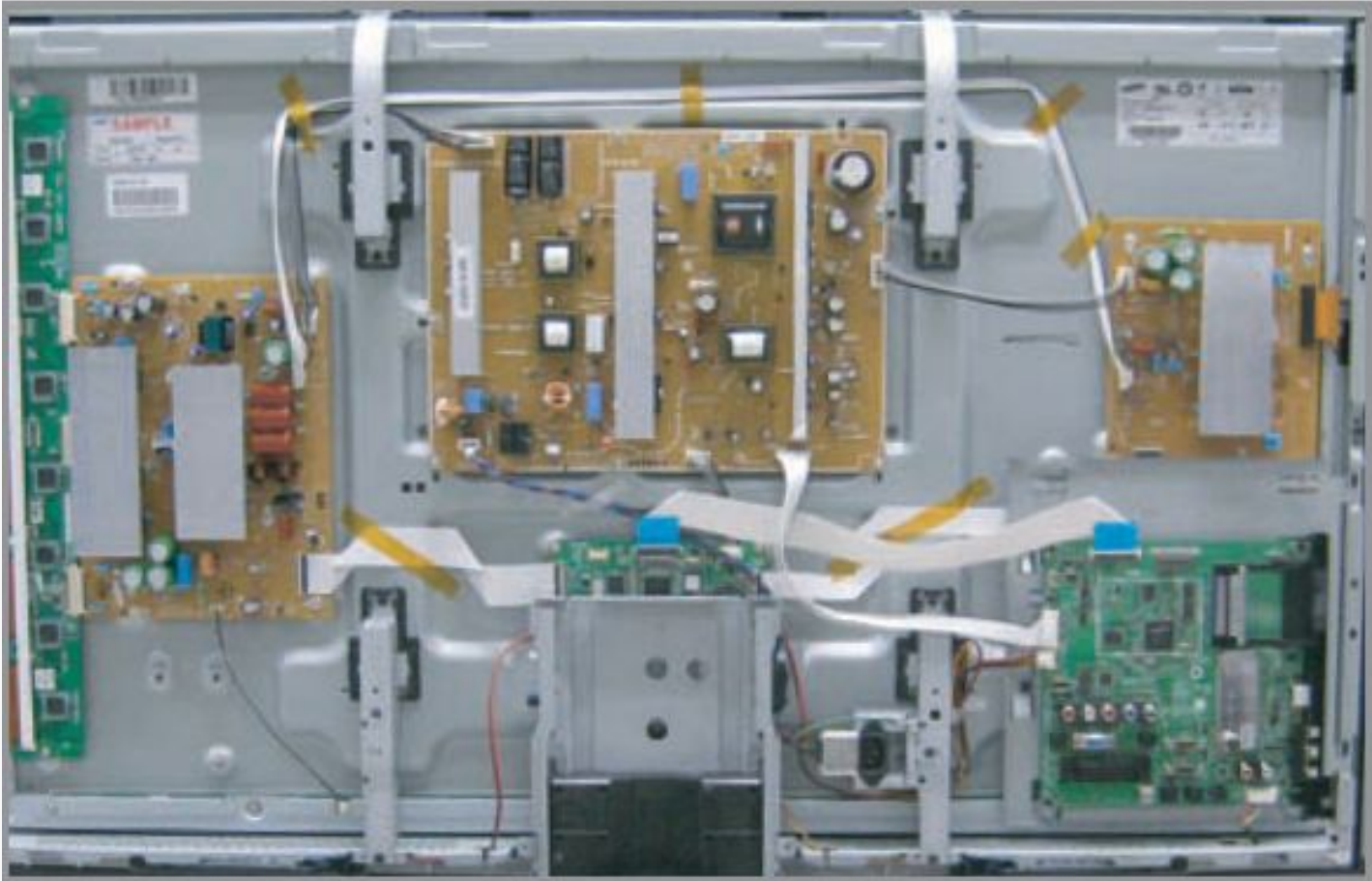

- Picture of P450 50" U1P PDP Module [Back view]

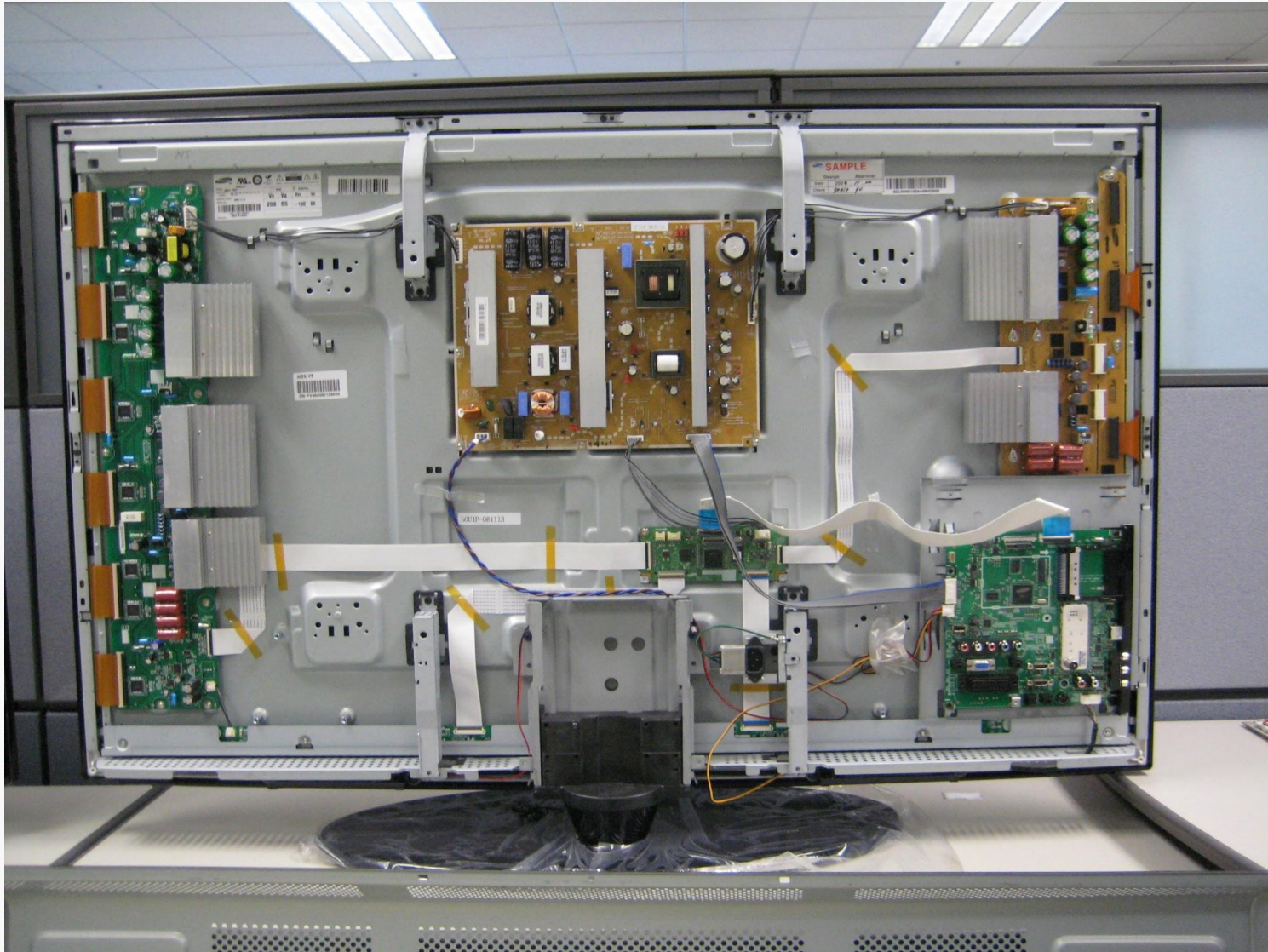

● Picture of PS42B450/PS50B450 Chassis

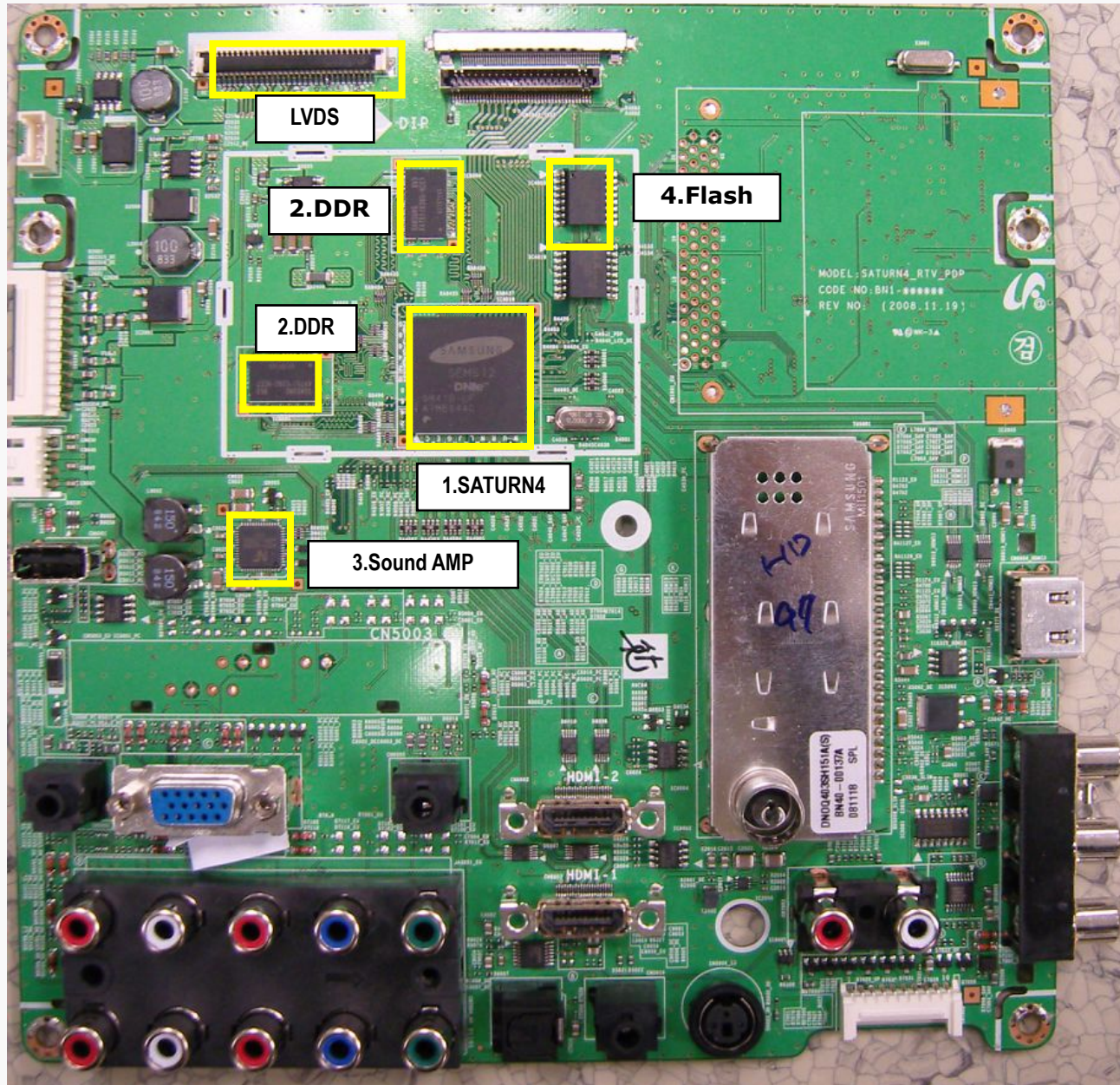

1	IC5001	IC-LCD CONTROLLER	SEMS01,LQFP,256P,30x30mm,PLASTIC,3.3V,2.2W,0to+70C,TR
2	IC6001	IC-VIDEO PROCESS	S4LF119X01,PBGA,208P,17x17mm,PLASTIC,3.6V,0to+70C,TR,FBEx
3	IC7001	IC-DECODER	UPD61211GM-104-GAA-A,QFP,216P,24x24mm,PLASTIC,3.3V,700mA,0to+70C,TR
4	IC3001	IC-VIDEO SWITCH	SiI9185CTU,QFP,80P,3.3V,0 to +70C,PLASTIC,TR
5	IC5201	IC-DDR SDRAM	EM6A9160TS0A-5G,DDR SDRAM,128Mbit,8Mx16,TSOP2,66P,22.22x10.16mm,5nS,2.375/2.625V,0to+70C,90m A TR
6	IC7002	IC-DRAM	HYB25D256163CE,DDR,256Mbit,16Mx16Bit,TSOP,66P,22.22x10.16mm,4ns,2.5/2.7V, -,0to+7
7	IC2001	IC-POWE AMP	NTP3100,QFN56,56P,8x8mm,DUAL,PLASTIC,24V,40W,-10to+85C

● Calibration (Component/HDMI/AV/PC)

■ White Balance – Calibration

If picture color is wrong, do calibration first.

Execute calibration in Factory Mode (AV mode example):

1. Source : VIDEO (AV mode)
2. Setting Video Mode (Timing) : PAL Video (MODE : #2)
3. Setting pattern : Pattern #24 (Chess Pattern)
4. Use Equipment : K-7256 or Equipment of equality level
5. Work order:
 - 1) Enter Factory Mode and select “2. WB Adjust” -> “Calibration”
 - 2) Select "AV CALIBRATION" and press the right button on the remote ()
 - 3) After completing calibration, the “Success...” message will be displayed next by “AV CALIBRATION”

For Component/HDMI mode use resolution of 1280x720/60Hz (MODE: #6)

For PC mode use resolution of 1024x768/60Hz (MODE: #21)

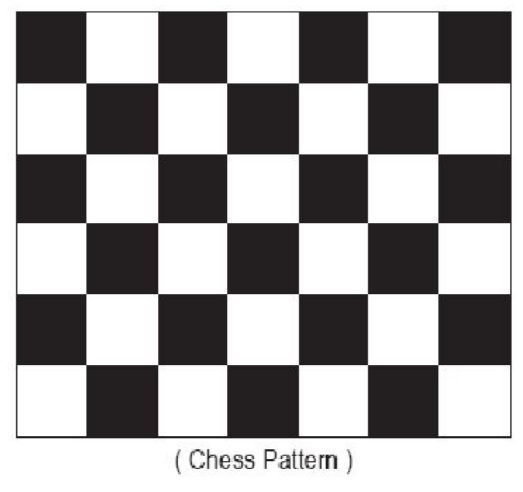

● White Balance Adjustment

■ White Balance - Adjustment

If picture color is wrong, check White Balance condition.

Equipment : CA210, Patten : Toshiba
Adjust W/B in Factory Mode

Sub brightness and R/G/B Offset controls low light region
Sub contrast and R/G/B Gain controls high light region

Source AV : PAL composite, Component : 1280*720/60Hz,
HDMI[DVI] : 1280*720/60Hz

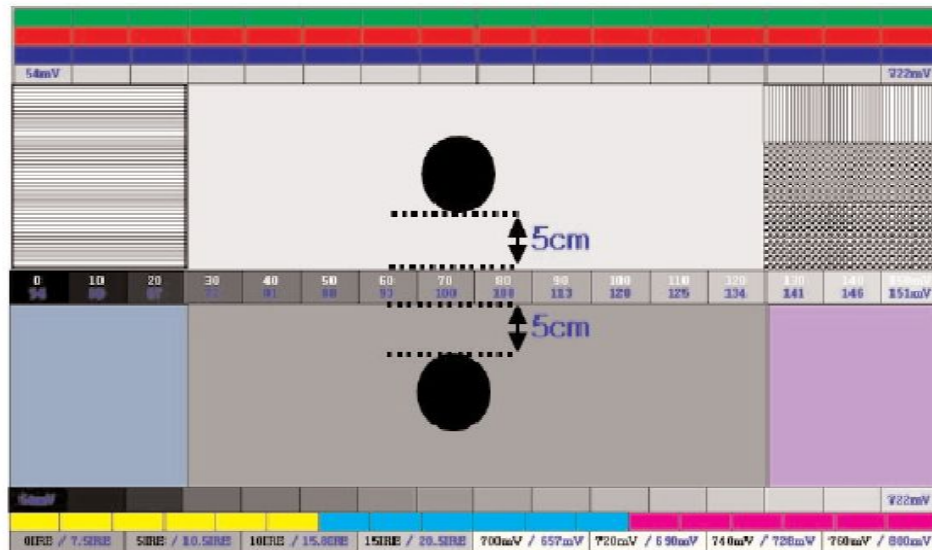

(SAMSUNG WHITE BALANCE Adjustment PATTERN with FPD)

The WB specification can be found on the G-TMS system.

- **Picture condition in Factory mode / during WB adjust**

No	Item	Status	Remark
1	Mode	Dynamic	
2	Colour Tone	Cool1	
3	Size	Auto Wide	Comp/PC/HDMI : Wide
4	Digital NR	Off	
5	DNle	Off	
6	Energy Saving	Off	
7	PIP	Off	

- **Factory mode OSD**

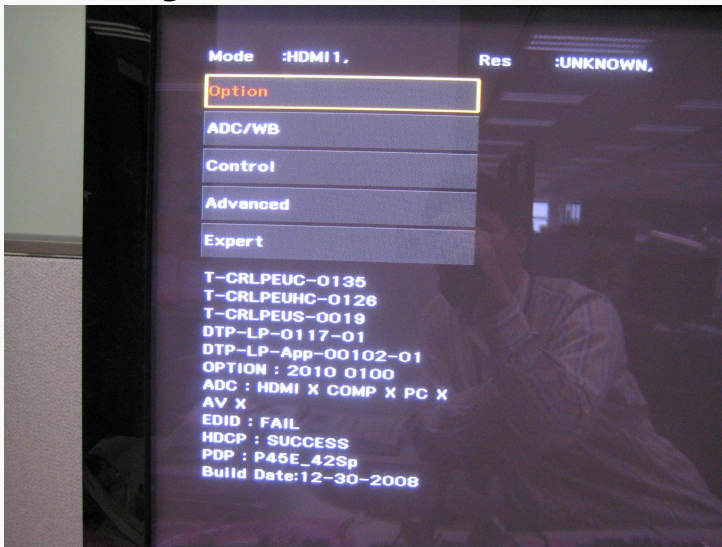

Viewing the Control Panel

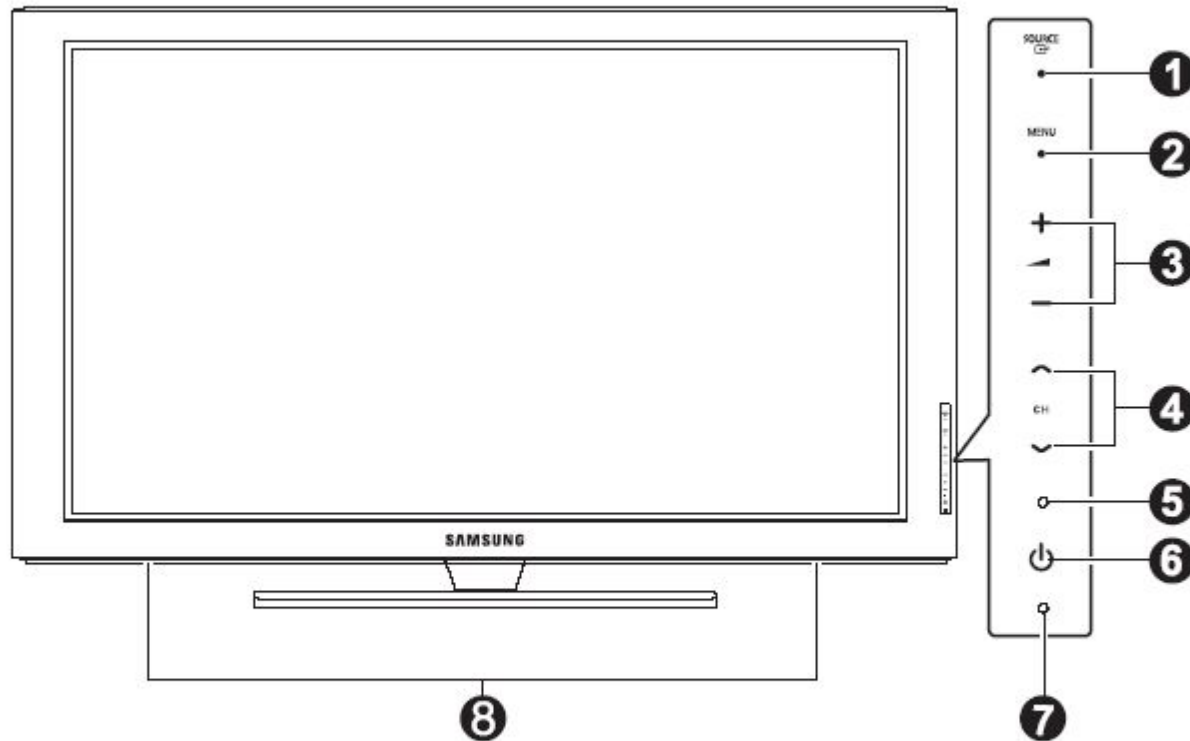

 The product colour and shape may vary depending on the model.

Front Panel buttons

Touch each button to operate.

1 SOURCE 

Toggles between all the available input sources (TV, Ext. AV, PC, Component, HDMI1, HDMI2/DVI, HDMI3).

 In the on-screen menu, use this button as you would use the **ENTER** button on the remote control.

2 MENU

Press to see an on-screen menu of your TV's features.

3 +  -

Press to increase or decrease the volume. In the on-screen menu, use the +  - buttons as you would use the ◀ and ▶ buttons on the remote control.

4 ^ CH v

Press to change channels. In the on-screen menu, use the ^ CH v buttons as you would use the ▲ and ▼ buttons on the remote control.

5 POWER INDICATOR

Lights up when the power is on.

6  (POWER)

Press to turn the TV on and off.

7 REMOTE CONTROL SENSOR

Aim the remote control towards this spot on the TV.

8 SPEAKERS

Viewing the Connection Panel

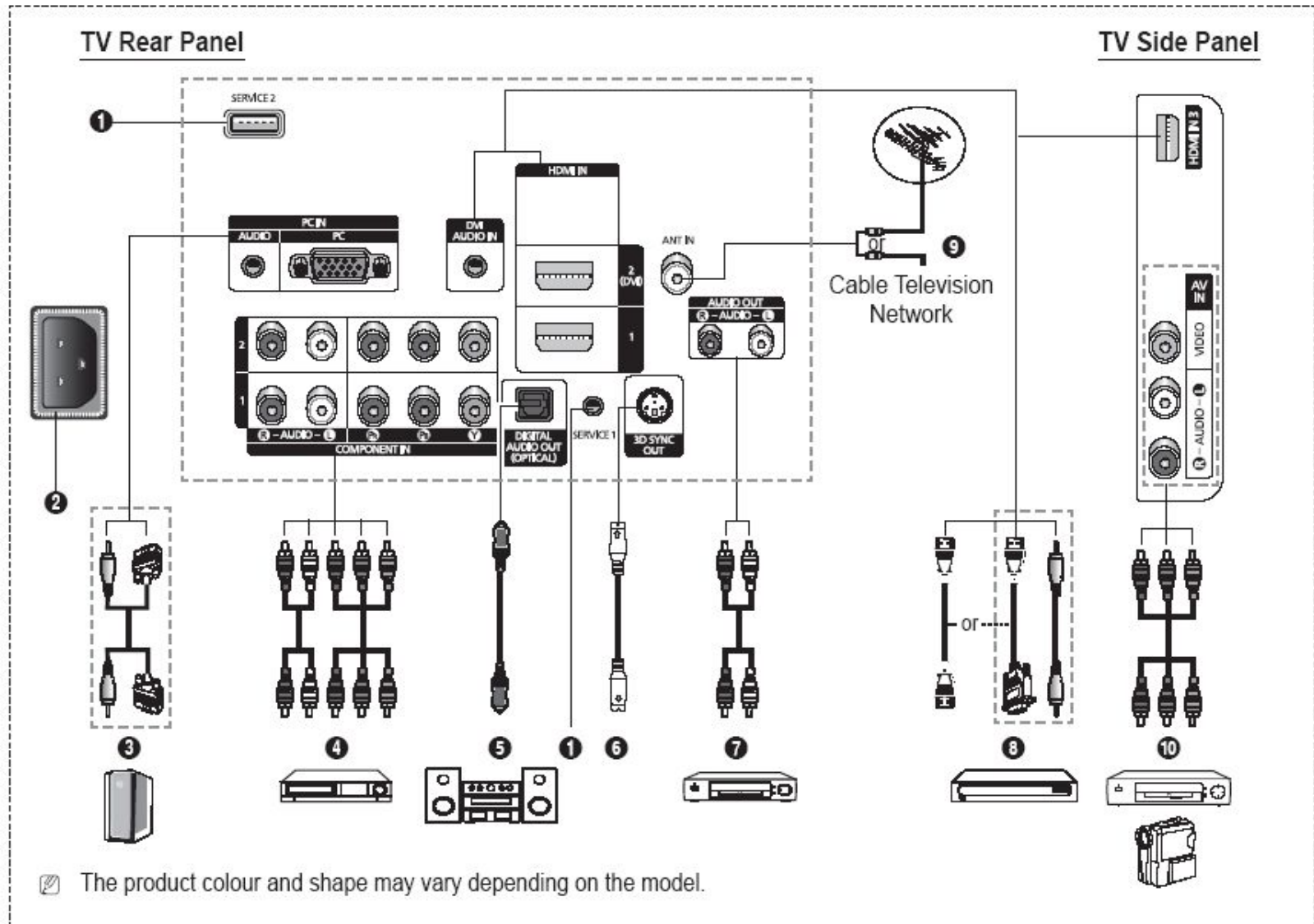

The product colour and shape may vary depending on the model.

- Whenever you connect an audio or video system to your set, ensure that all elements are switched off.
- When connecting an external device, match the colour of the connection terminal to the cable.

- ❶ **SERVICE 1, 2**
Connector for service.
- ❷ **POWER IN**
Connect the supplied power cord.
- ❸ **PC IN(PC) / (AUDIO)**
Connect to the video and audio output jack on your PC.
- ❹ **COMPONENT IN 1, 2**
Audio (AUDIO L/R) and video (Y/P_B/P_R) inputs for Component.
- ❺ **DIGITAL AUDIO OUT (OPTICAL)**
Connect to a Digital Audio Component.
- ❻ **3D SYNC OUT**
Connect to 3D IR Emitter
- ❼ **AUDIO OUT(AUDIO R/L)**
Connect RCA audio signals from the TV to an external source, such as Audio equipment.
- ❽ **HDMI IN 1, 2, 3**
 - No additional Audio connection is needed for an HDMI to HDMI connection.
 - When using an HDMI/DVI cable connection, you must use the HDMI IN 2 (DVI) jack.

✍ **What is HDMI?**

- **High Definition Multimedia interface** allows the transmission of high definition digital video data and multiple channels of digital audio.
- The HDMI/DVI terminal supports DVI connection to an extended device with the appropriate cable (not supplied). The difference between HDMI and DVI is that the HDMI device is smaller in size, has the HDCP (High Bandwidth Digital Copy Protection) coding feature installed, and supports multi - channel digital audio.

DVI AUDIO IN

DVI audio outputs for external devices.

❹ **ANT IN**

75Ω Coaxial connector for Aerial/Cable Network.







❿ **AV IN (VIDEO / AUDIO R/L)**

Video and audio inputs for external devices, such as a camcorder or VCR.

Supported modes for HDMI/DVI and Component

	480i	480p	576i	576p	720p	1080i	1080p
HDMI/DVI 50Hz	X	X	X	O	O	O	O
HDMI/DVI 60Hz	X	O	X	X	O	O	O
Component	O	O	O	O	O	O	O

Accessories



	Accessories	Item	Item code	Remark
Supplied Accessories		Remote Control Batteries	BN59-00863A	Samsung Service center
		Power Cord	3903-000144	
		Owner's Instructions	BN68-01936A	
		Warranty Card Registration Card Safety Guide Manual	BN68-00514E	
		Cloth-Clean	BN63-01798A	
		Ferrite Core for Power Cord	3301-001305	
		Cover-Bottom Screws (2ea)	BN63-03055A 6003-001621	

2. Disassembly

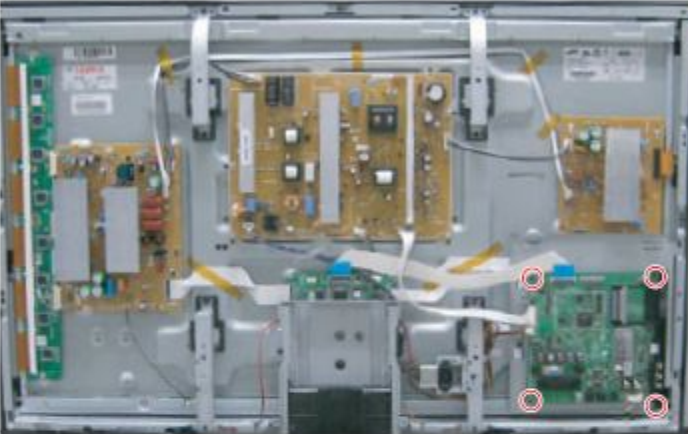

Separation of ASSY COVER P-REAR

Part Name	Description	Description Photo
Cover Rear	<p>① Remove 17 screws. (○) : BH,+,B,M4,L3,ZPC(BLK)</p> <p>② Remove 6 screws. (○) : PH,+,WSP,S,M4,L35,ZPC(BLK)</p> <p>③ Remove the rear cover.</p> <p>⚠: Please lay the PDP unit face down on a soft surface when removing the stand.</p>	 <p>The photo shows the back of a Samsung PDP unit. Red circles mark 17 screw locations: 12 along the top edge, 4 along the bottom edge, and 1 on the right side. Blue circles mark 6 screw locations: 2 on the left side and 4 in the bottom center. To the right of the photo are two inset images: the top one shows a black screw with a red circle next to it, and the bottom one shows a silver screw with a blue circle next to it.</p>

Separation of ASSY PCB MISC-MAIN

Part Name	Description	Description Photo
<p>Main Board</p>	<p>① Detach all connectors from the Main Board.</p> <p>② Remove 4 screws. : PH,+,WWP,M3,L8,NI PLT</p> <p>③ Remove the Main Board.</p> <p>▶ The photo is for 42". 50" is very similiar with 42".</p>	<p><42"></p>  <p><50"></p> 

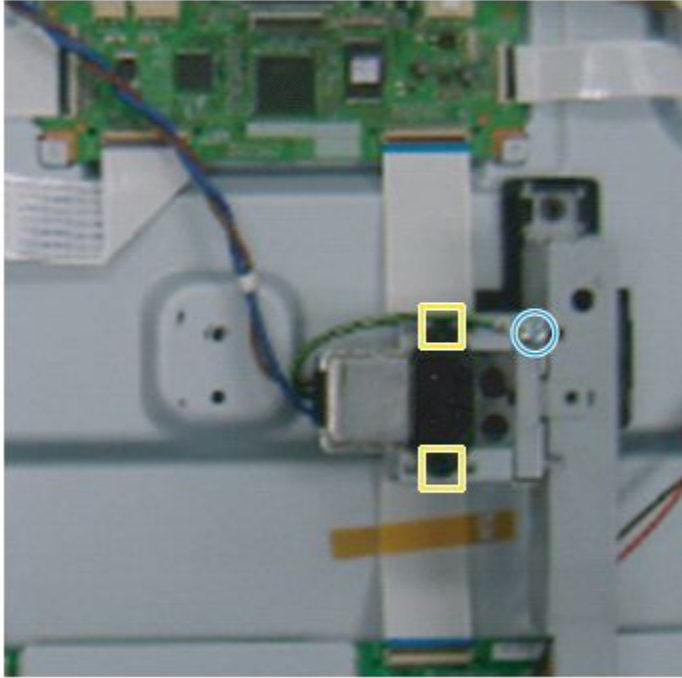

Separation of FILTER-EMI AC LINE

Part Name	Description	Description Photo
FILTER-EMI AC LINE	<ol style="list-style-type: none">① Detach connector from SMPS.② Remove 2 screw. (□) : PH,+,WWP,M3,L8,NI PLT③ Remove 1 screws.(○) : BH,+,S,M4,L10,ZPC(BLK)④ Separate FILTER-EMI AC LINE from bracket.	 <p>The photo shows the internal components of the device. A green PCB is visible at the top. A blue and red cable is connected to a component. A white bracket is mounted on the device. Two yellow squares (□) highlight screws on the bracket. One blue circle (○) highlights a screw on the right side of the device.</p>  <p>The legend shows a blue circle (○) next to a silver screw and a yellow square (□) next to a silver screw.</p>





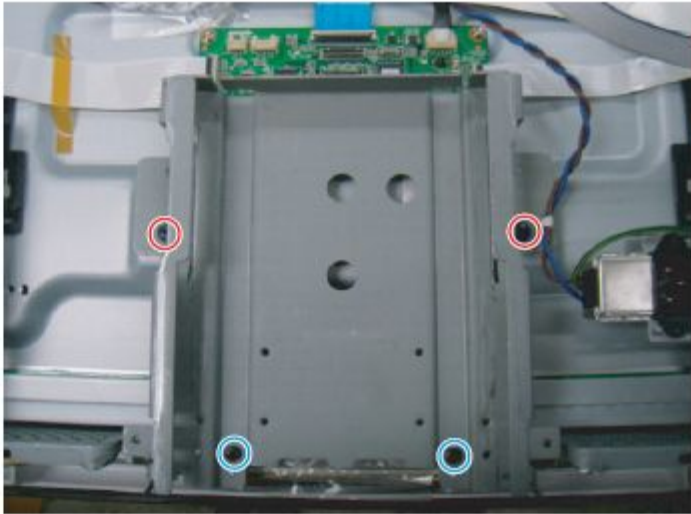



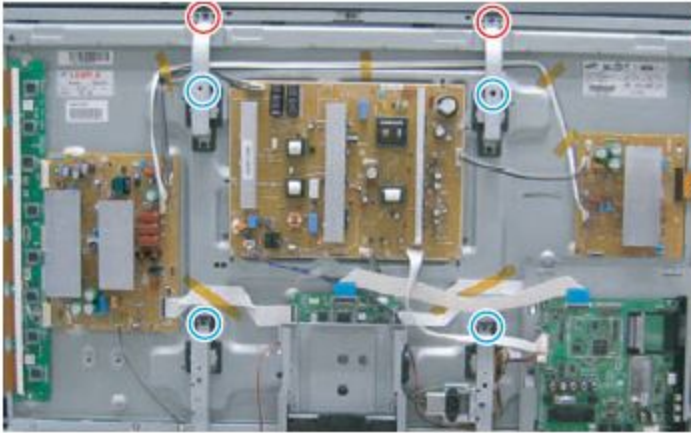

Separation of BRACKET-PCB

Part Name	Description	Description Photo
Bracket PCB	<p>① Remove screw.(○) : BH,+,B,M4,L3,ZPC(BLK)</p> <p>② Remove the BRACKET-PCB.</p>	



Separation of ASSY BRACKET 42"/50"

Part Name	Description	Description Photo
Bracket	<p>① Remove 2 screws. (○) : BH,+,PT,S Tite,M4,L10,ZPC(BLK)</p> <p>② Remove 2 screws. (○) : BH,+,B,M4,L3,ZPC(BLK)</p> <p>③ Remove Bracket.</p>	  



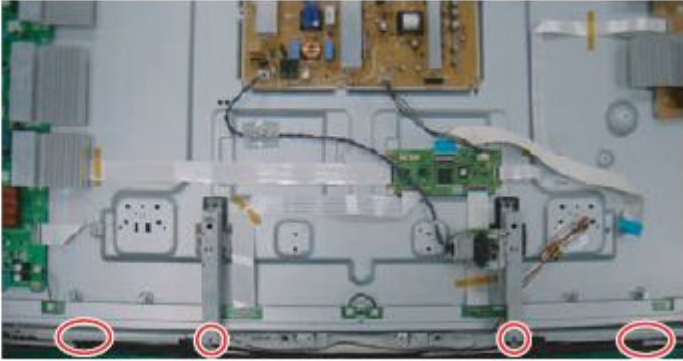

Separation of ASSY BRACKET P-WALL

Part Name	Description	Description Photo
<p>42" Wall Bracket</p>	<p>① Remove 2 screws. (○) : BH,+,B,M4,L3,ZPC(BLK)</p> <p>② Remove 4 screws. (○) : BH,+,S,M4,L10,ZPC(BLK)</p> <p>③ Remove Wall Bracket.</p> <p>⚠: Please lay the PDP panel face down on a soft surface when separating front cover.</p>	 <div data-bbox="1574 268 1802 454">     </div>
<p>50" Wall Bracket</p>	<p>① Remove 2 screws. (○) : BH,+,B,M4,L3,ZPC(BLK)</p> <p>② Remove 4 screws. (○) : BH,+,S,M4,L10,ZPC(BLK)</p> <p>③ Remove Wall Bracket.</p>	 <div data-bbox="1574 761 1802 946">     </div>

Separation of ASSY SPEAKER P

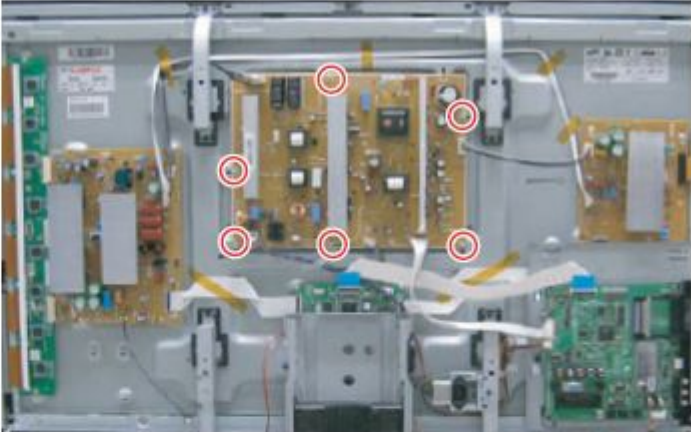
Part Name	Description	Description Photo
Speaker	<p>① Remove 4 screws.(○) : BH,+,WP,B,M4.0,L3,ZPC(BLK), SWRCH18A</p> <p>② Remove the Speaker.</p> <p>▶ The photo is for 42". 50" is very similiar with 42".</p>	 

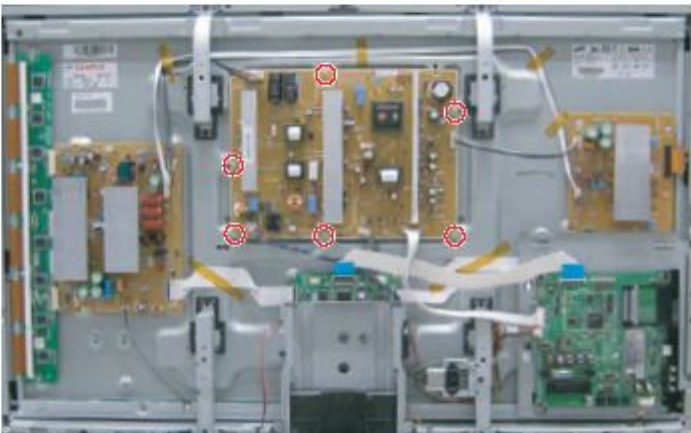
Separation of SMPS-PDP TV

Part Name	Description	Description Photo
42" SMPS	<p>① Detach all connectors from the SMPS.</p> <p>② Remove 6 screws. : PH,+,WWP,M3,L8,NI PLT</p> <p>③ Remove the SMPS.</p> <p>⚠: Wear gloves when handling the power board as there may be some remaining electrical charge in the capacitor. Specifically, avoid touching any part of the capacitor.</p>	 
50" SMPS	<p>① Detach all connectors from the SMPS.</p> <p>② Remove 6 screws. : PH,+,WWP,M3,L8,NI PLT</p> <p>③ Remove the SMPS.</p>	 

Separation of ASSY PDP MODULE

P-LOGIC MAIN BOARD

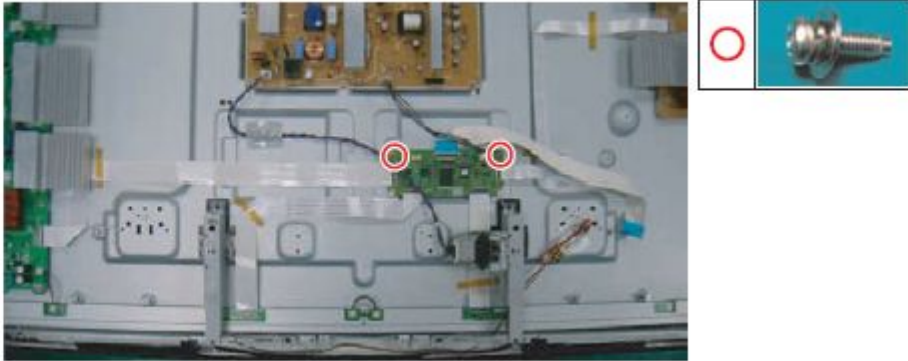
Part Name	Description	Description Photo
Logic Board	<ul style="list-style-type: none">① Detach all connectors from the Logic Main Board. ② Remove 2 screws. : WSP,PH,+,M3,L8,NI PLT ③ Remove the Logic Main Board.	

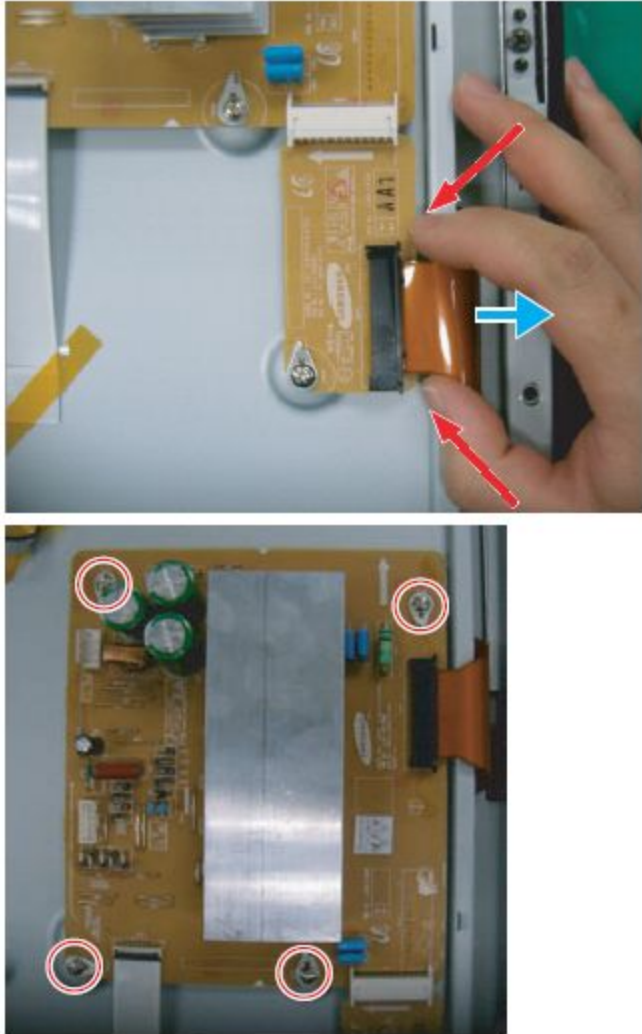

Separation of ASSY PDP MODULE P-X MAIN BOARD

Part Name	Description	Description Photo
42" Flat able	<p>① Detach all Connectors from the X Main Board.</p> <p>※ To separate the Flat Cable of the X-Board, press the upper and the lower sides of the connector.</p> <p>⚠: Pinch the sides, but then push down in the ribbon, it should slide out after that.</p>	

Separation of ASSY PDP MODULE P-X MAIN BOARD

<p>42" X-Main Board</p>	<p>① Remove 7 screws. : PH,+,WWP,M3,L8,NI PLT</p> <p>② Remove the X-Main Board.</p>	
<p>50" X-Main Board</p>	<p>① Remove the X-Main Board.</p>	

Separation of ASSY PDP MODULE P-Y MAIN BOARD

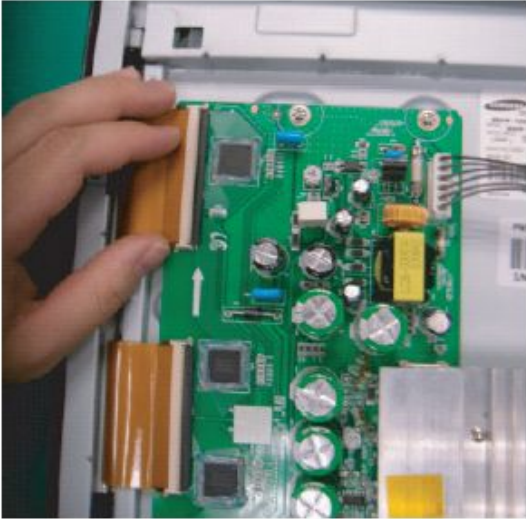
Part Name	Description	Description Photo
42" Flat Cable	① Detach the scan board connectors from the panel .	 
50" Flat Cable	① Detach the scan board connectors from the panel .	

Separation of ASSY PDP MODULE P-Y MAIN BOARD

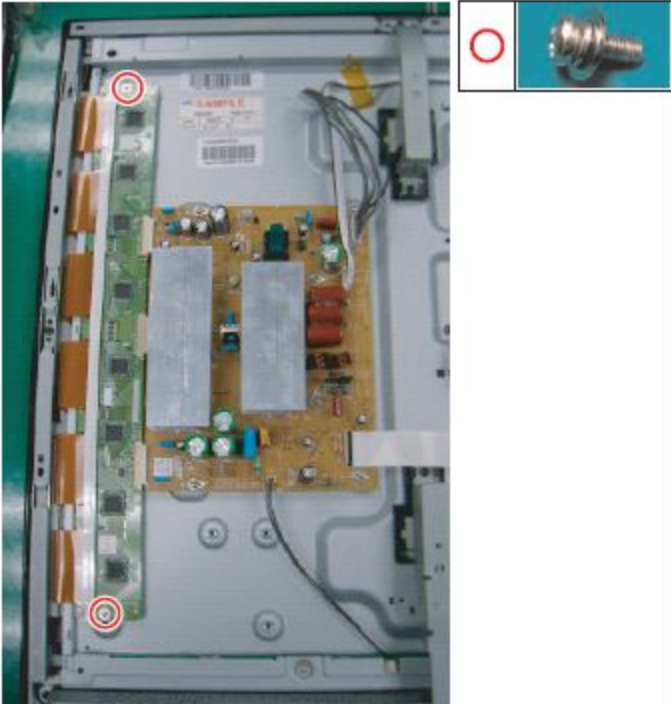

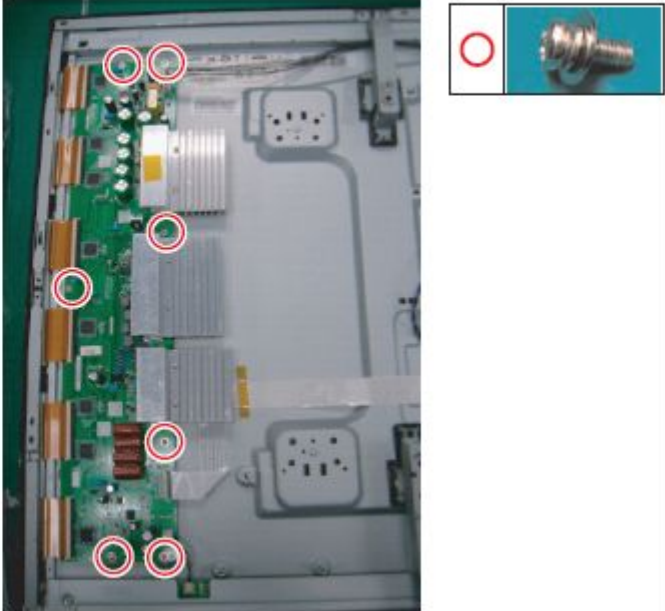

<p>42" Y-Scan Board</p>	<p>① Remove 2 screws. : PH,+,WWP,M3,L8,NI PLT</p>	
---------------------------------	---	--

Separation of ASSY PDP MODULE P-Y MAIN BOARD

Part Name	Description	Description Photo
50" Y-Scan Board	① Remove 7 screws. : PH,+,WWP,M3,L8,NI PLT	

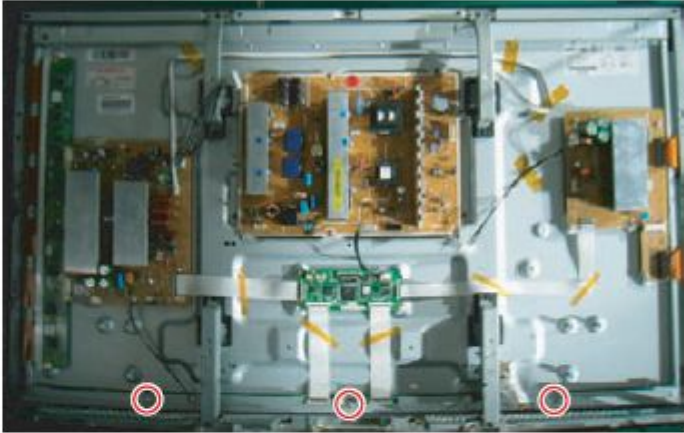
Separation of ASSY PDP MODULE

P-ADDRESS BUFFER BOARD

Part Name	Description	Description Photo
42" Buffer board shield	<ol style="list-style-type: none"> ① Remove 3 screws. : PH,+,WWP,M3,L8,NI PLT ② Remove the still bar. <p>▶ Before removing the still bar, you should lift up the panel a little.</p>	 
50" Buffer board shield	<ol style="list-style-type: none"> ① Remove 3 screws. : PH,+,WWP,M3,L8,NI PLT ② Remove the still bar. <p>▶ Before removing the still bar, you should lift up the panel a little.</p>	 

Separation of ASSY PANEL BRACKETS

Part Name	Description	Description Photo
Panel Brackets	<p>① Remove 7 screws. (○) : BH,+,B,M4,L3,ZPC(BLK)</p> <p>② Remove the Side Panel Brackets.</p>	

3. Trouble shooting

● PS50A450 SW update method using the D/L jig

1. Connect the PC and PDP using D-SUB Cable and D/L jig

Step by Step



2. Run the Flash download program ISP_Tool v4.3.0



Picture of D/L jig

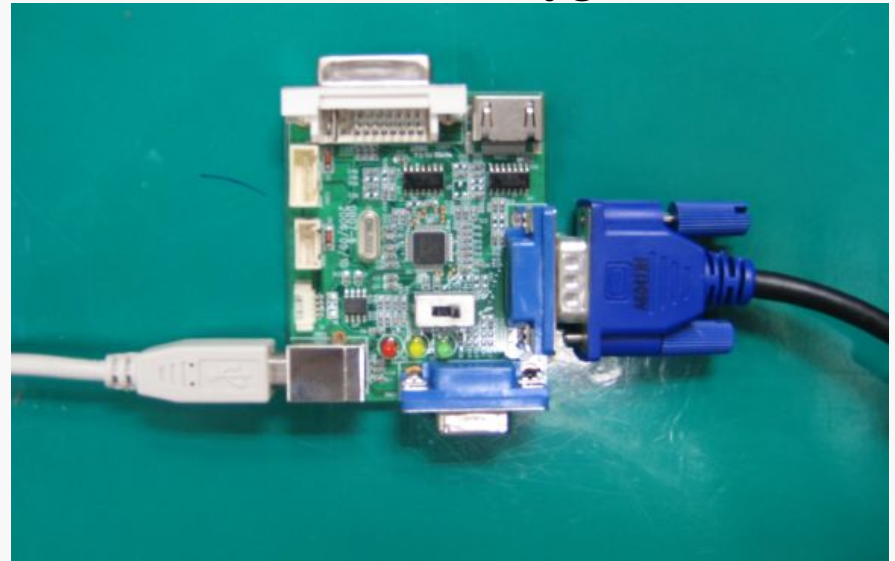

3. Click “Connect” button



4. Now the connection with the SET is established. Click the “확인”

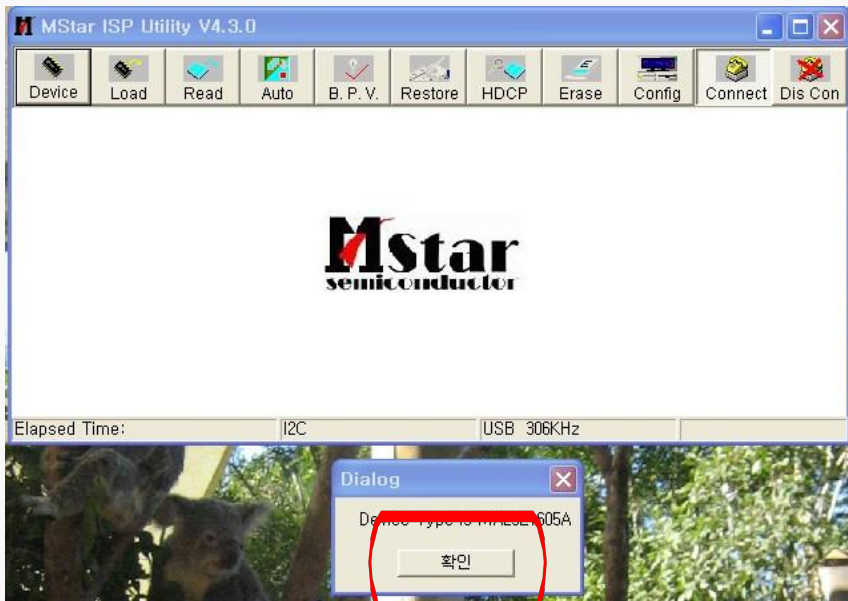

5. Connect the Power cord and click “Read”

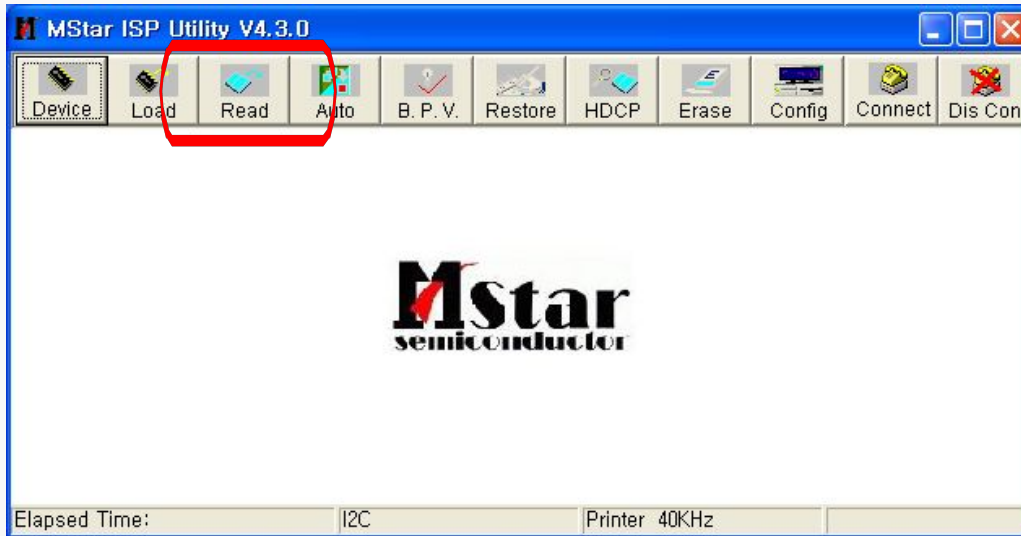

6. Click the new “Read” button

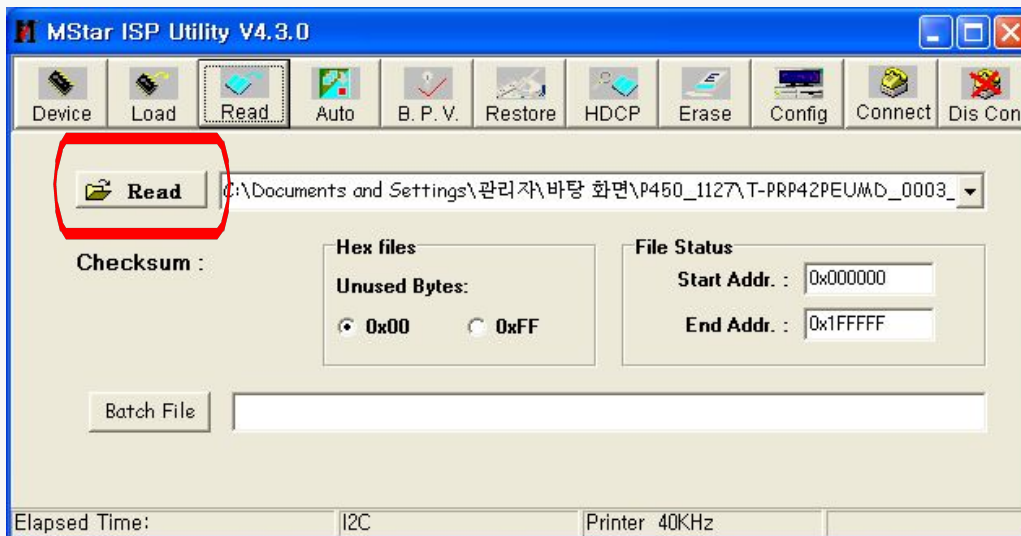

7. Select the upgrade file

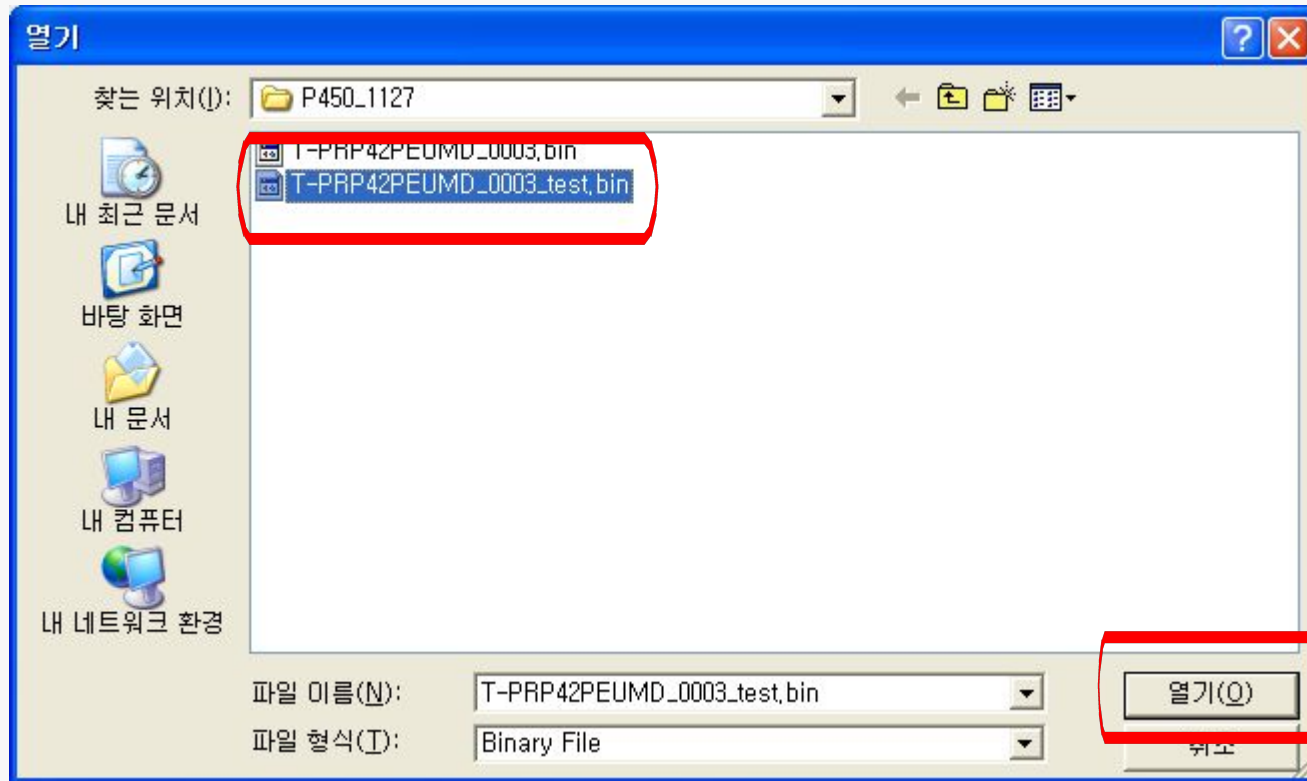

8. Click “Auto” button, uncheck the Blank and Verify options and click “Run”

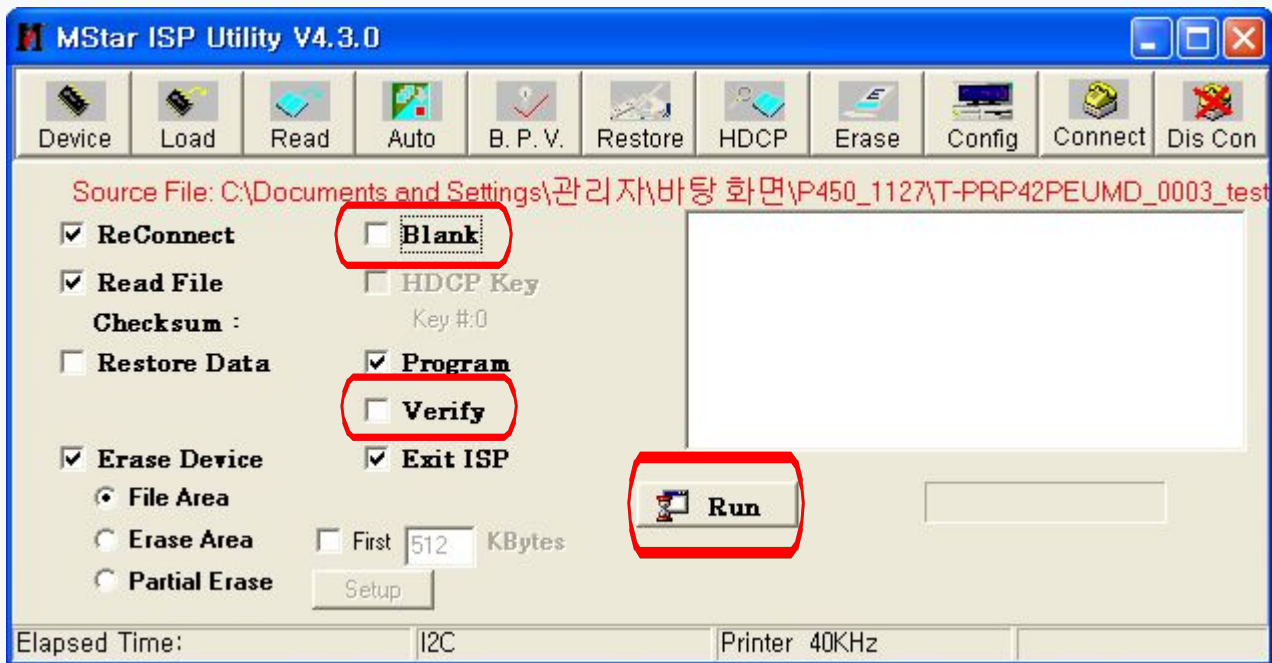

9. The download progress bar appears and D/L information is shown in the info window

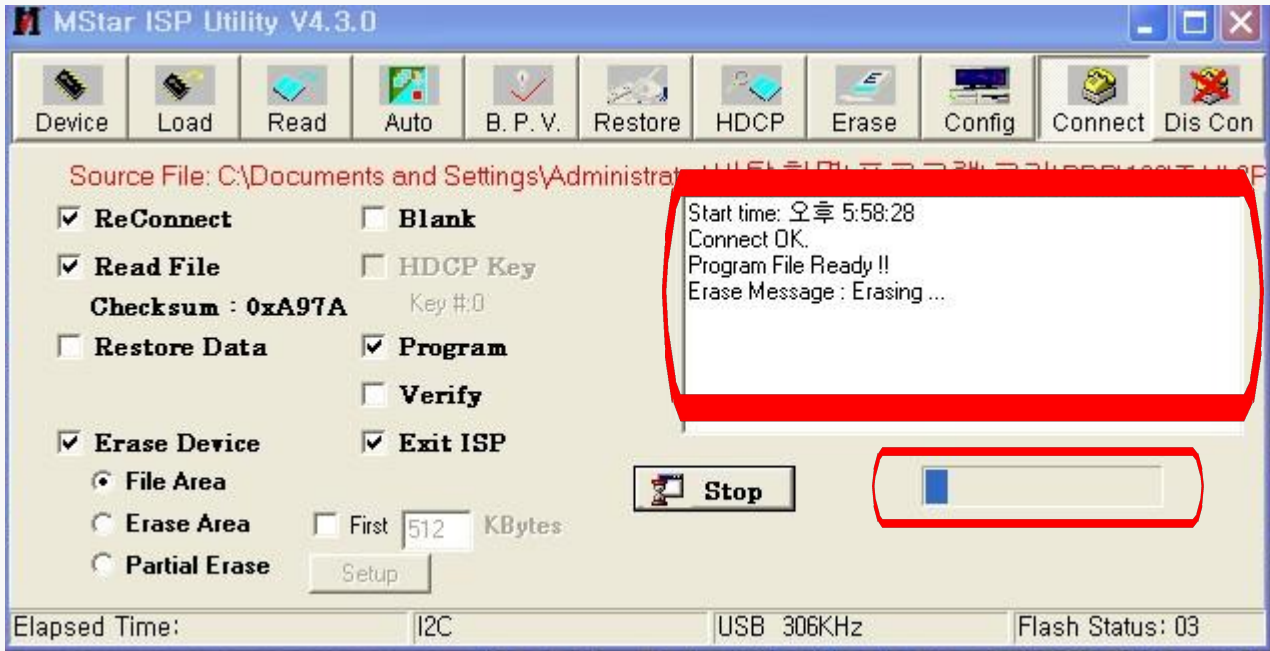

● PS50A450 SW update method using the USB

1. Copy the Upgrade Files into the path "T-CRLAUSC" in USB flash driver.

2. USB Download

- ① Insert the USB Memory Stick to the USB port in Stand-by mode.
- ② Turn the power on.
- ③ Press "MENU" and find "SW Upgrade" in Menu "SETUP".
- ④ Select the "SW Upgrade" from the menu.
- ⑤ Select "USB" from the menu.
- ⑥ The banner OSD "Scanning for USB..." is displayed.
- ⑦ The banner OSD "Upgrade version **** to version *****" is displayed.
Select "Yes".
- ⑧ The banner OSD "Upgrade version **** to version *****" is displayed.
It takes about 30 sec.
(Warning: Don't remove USB flash driver during upgrade.)
- ⑨ The banner OSD "Upgrade is completed" is displayed when the upgrade is completed.
- ⑩ Remove the USB flash driver from PDP TV and check the program version.

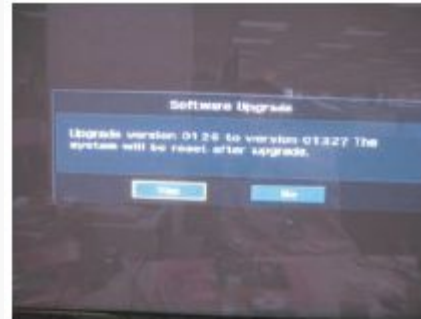

● Check List in advance

■. Each cable connection condition check

- Cable is connected correctly ?

■. Check Voltage

- SMPS □ □ Video main Board, SMPS □ □ X,Y Drive board, SMPS □ □ Logic board

■. The chart below shows abnormal condition

Condition Name	Description	Related Board
No Voltage Output	Operating Voltages don't exist.	SMPS
No Display	Operating Voltages exist, but an Image doesn't exist on screen	Y-MAIN, X-MAIN, Logic Main, Cables, Main
Abnormal Display	Abnormal Image(not open or short) is on screen.	Y-MAIN, X-MAIN, Logic Main
Sustain Open	some horizontal lines don't exist on screen	Scan Buffer, FPC of X / Y
Sustain Short	some horizontal lines appear to be linked on screen	Scan Buffer, FPC of X / Y
Address Open	some vertical lines don't exist on screen	Logic Main, Logic Buffer, FFC, TCP
Address Short	some vertical lines appear to be linked on screen	Logic Main, Logic Buffer, FFC, TCP

● No Power

- Not operate front LED
- Not operate SMPS relay

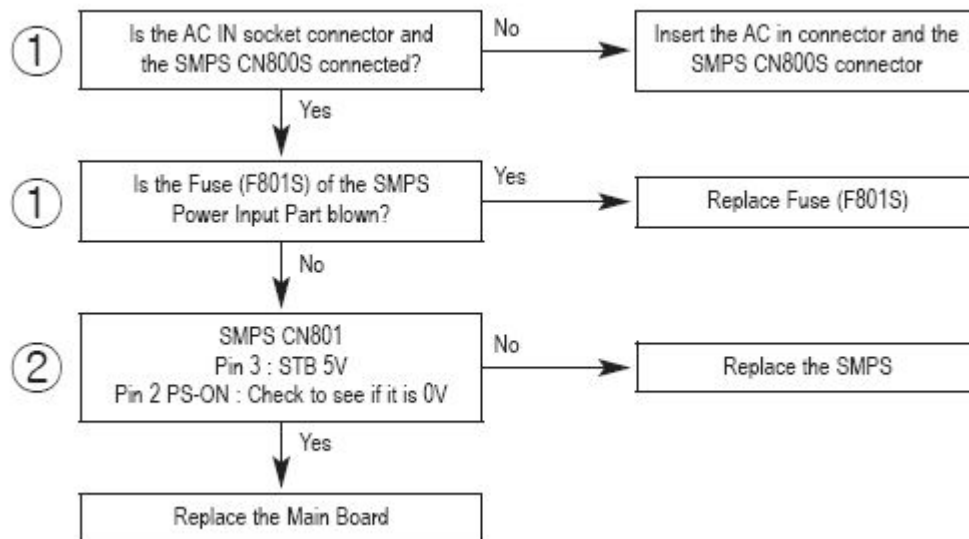
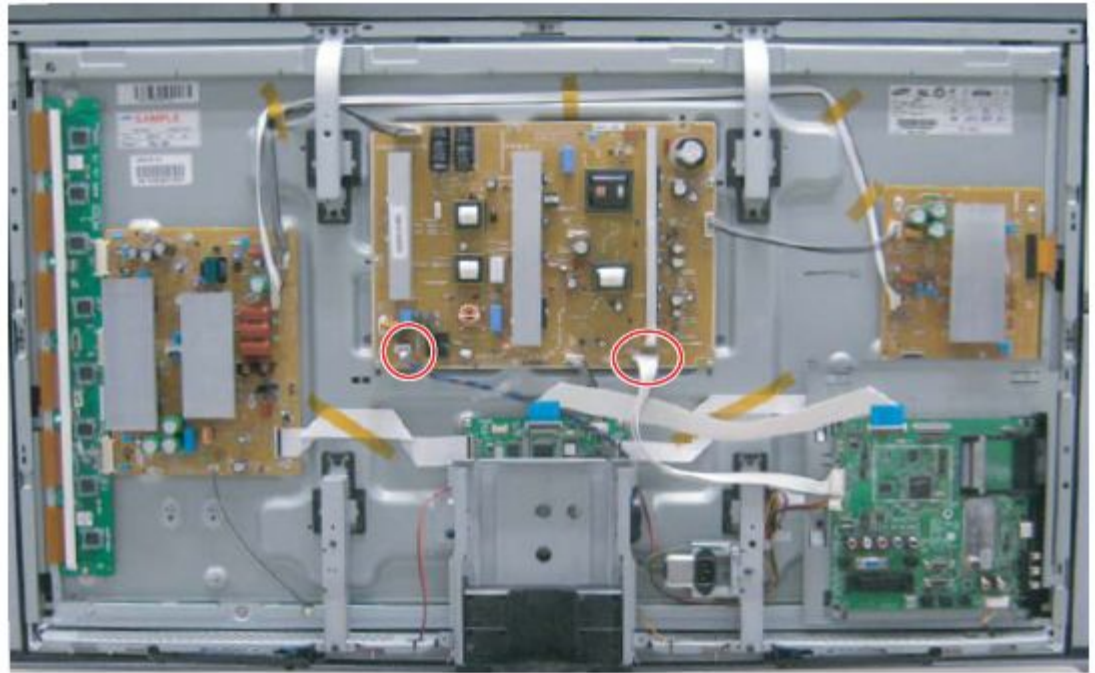

● SMPS relay on <-> off continually

- Operate Protection circuit because
- of some Ass'y problem

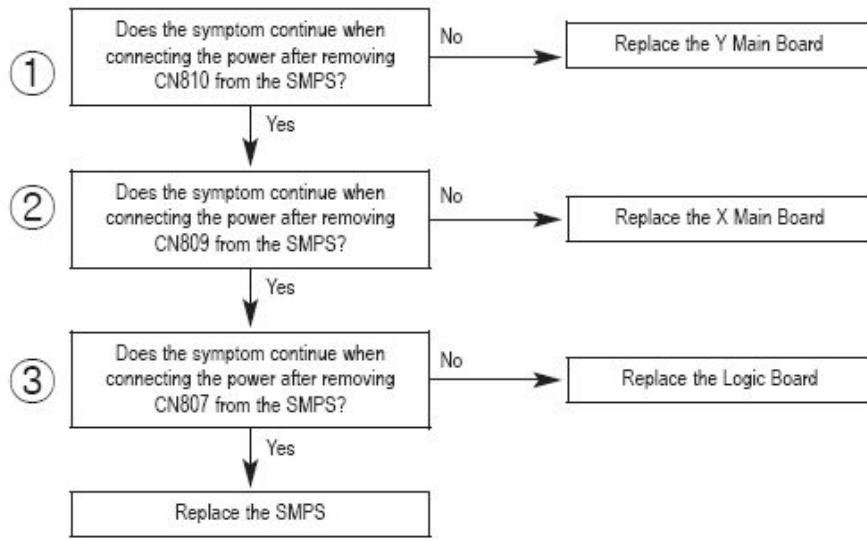
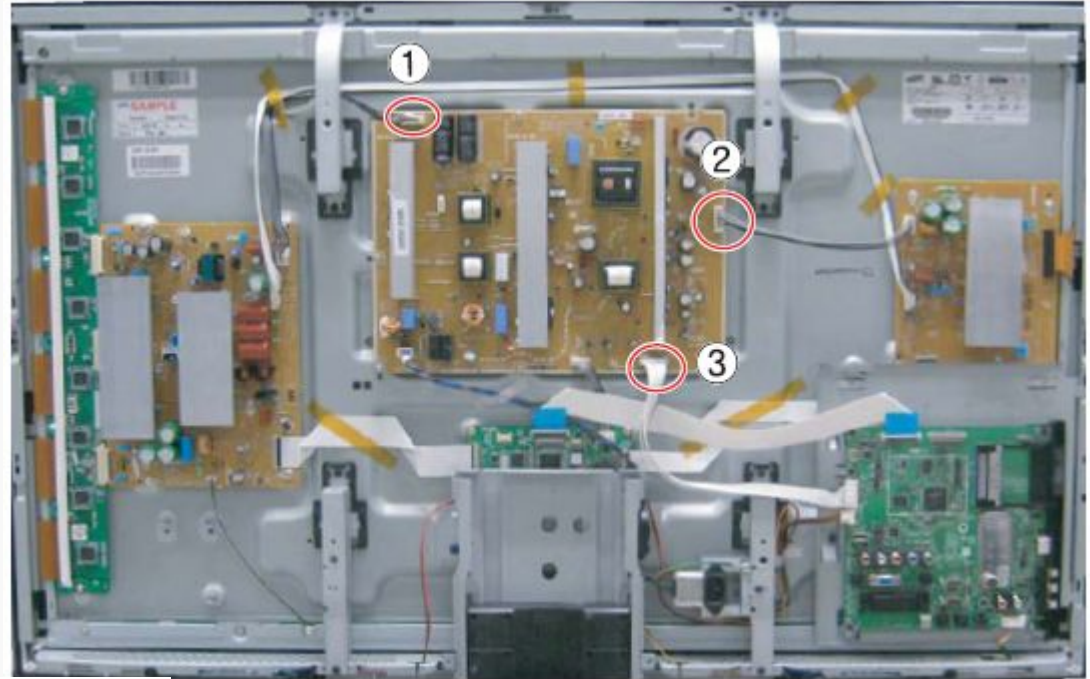

● No display but sound is normal

- X or Y or Logic or Y Buffer board is abnormal
- SMPS output Voltage is abnormal

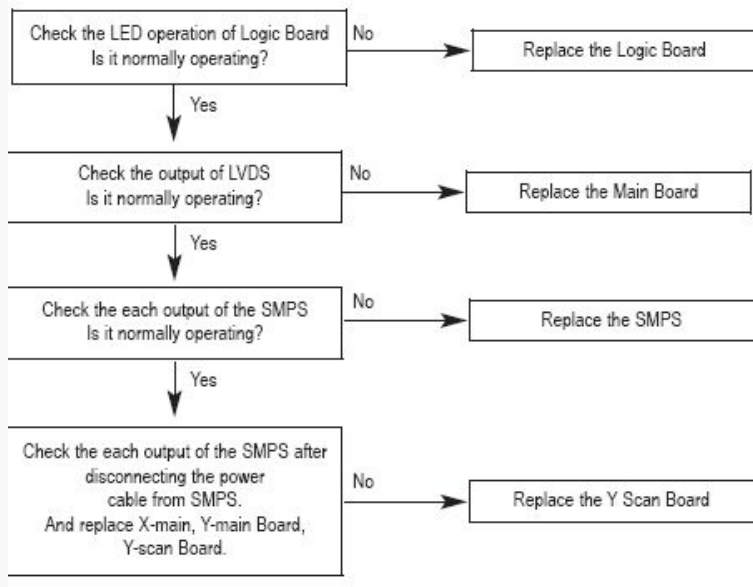
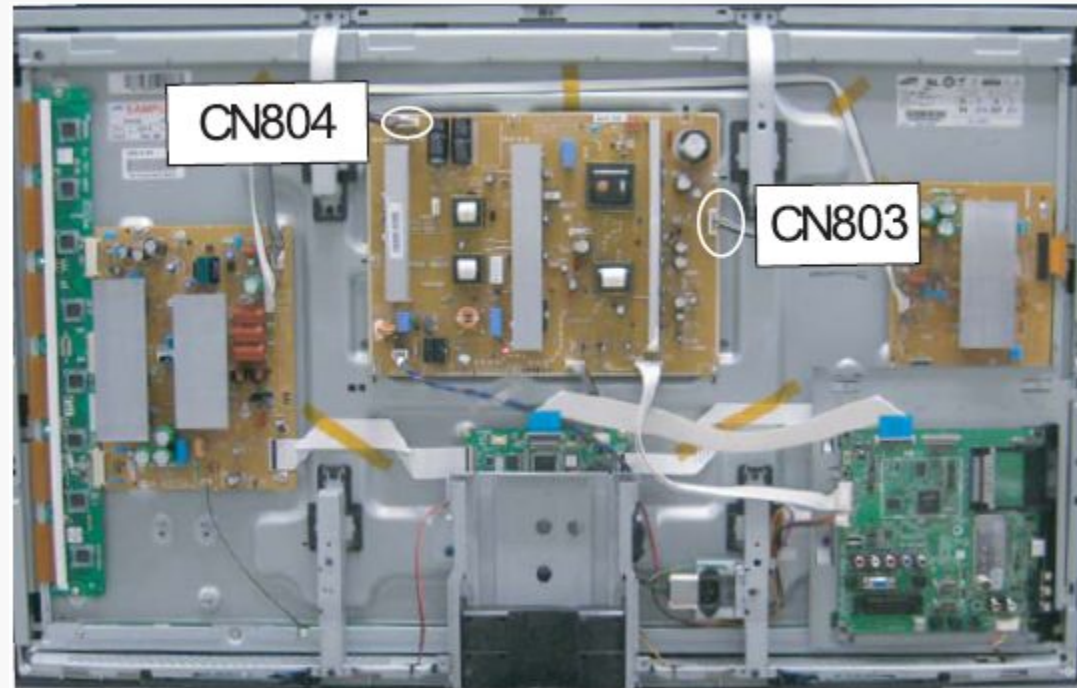

● No sound but display is normal ●

- Speaker wire is not connect
- Video main board sound part defect
- Speaker part defect
- Volume level is "0"(Non-sense)

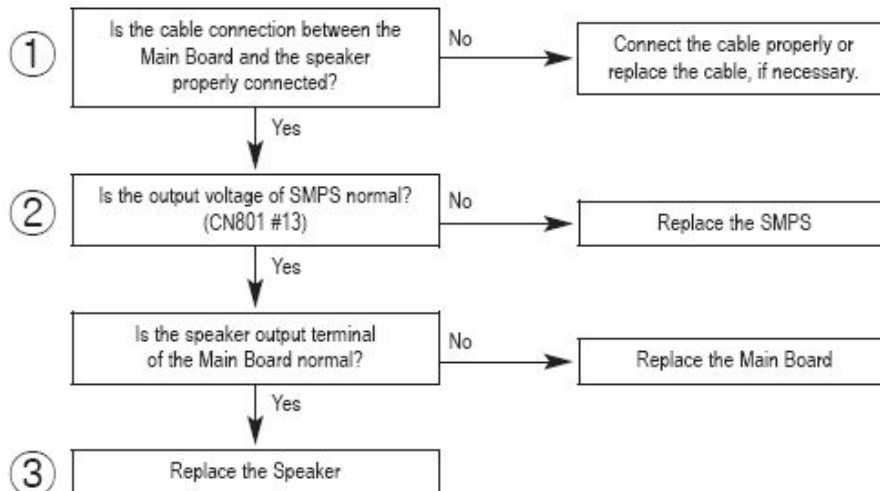
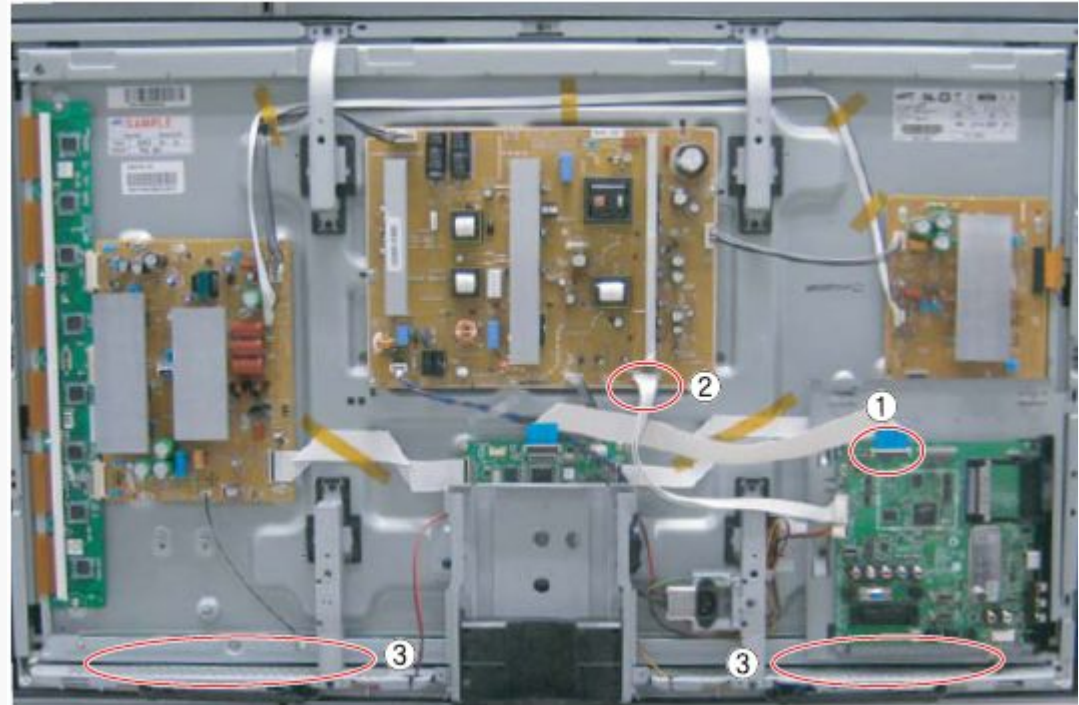

● PDP Dot Module SPEC – SDI module

Item		A Zone	B Zone	Remark
Product	Type			
42" (SD)	Dar k	1	6	
	Br i ght	0	1	
	Fl i cker i ng	0	1	
	TOTAL	7		
42" (HD)	Dar k	3	8	
	Br i ght	0	1	
	Fl i cker i ng	1	2	
	TOTAL	10		
50"	Dar k	3	8	
	Br i ght	0	1	
	Fl i cker i ng	1	2	
	TOTAL	10		
63"	Dar k	3	8	
	Br i ght	0	1	
	Fl i cker i ng	1	2	
	TOTAL	10		

✳ Special Management Items

1) It is Cell-Defect if there are dark, bright, flickering cells over **2 points** within **1.5cm** in the boundary section.

2) Before vibration/dropping test, it should be decided whether the module is good / badness first.

And after vibration/dropping test, if Cell-Defect happens more than preceding descriptions on Specification, it is Cell-Defect module.

- **A-Zone / B-Zone Size**

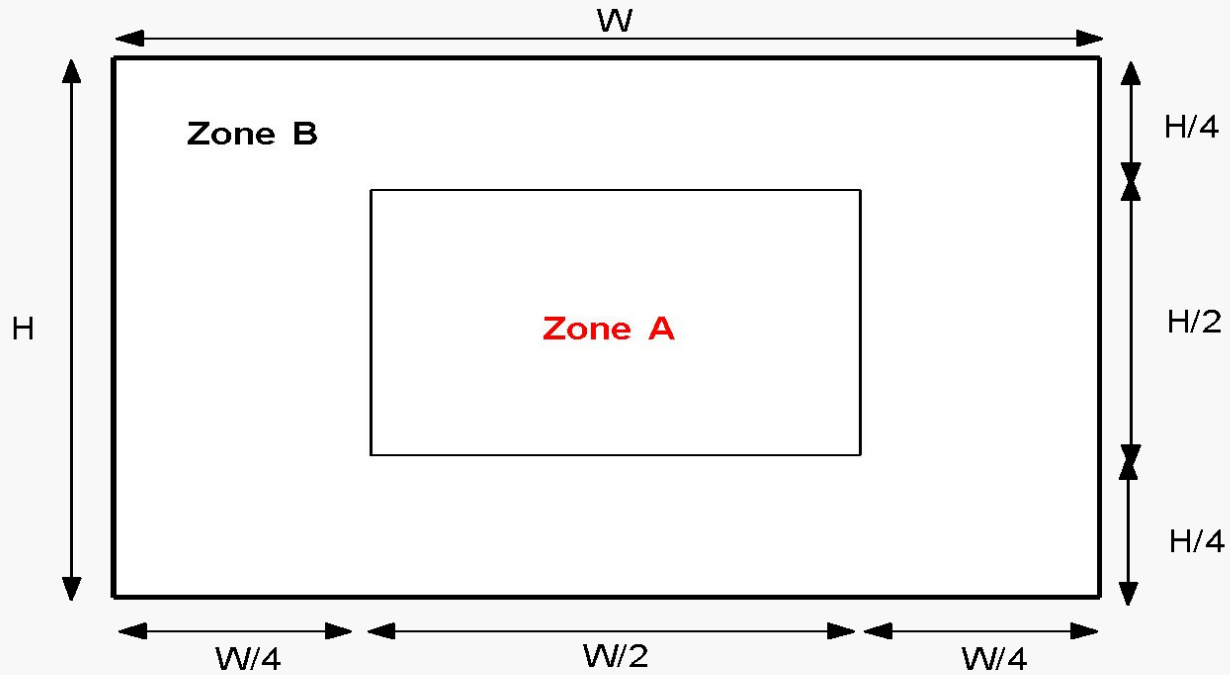
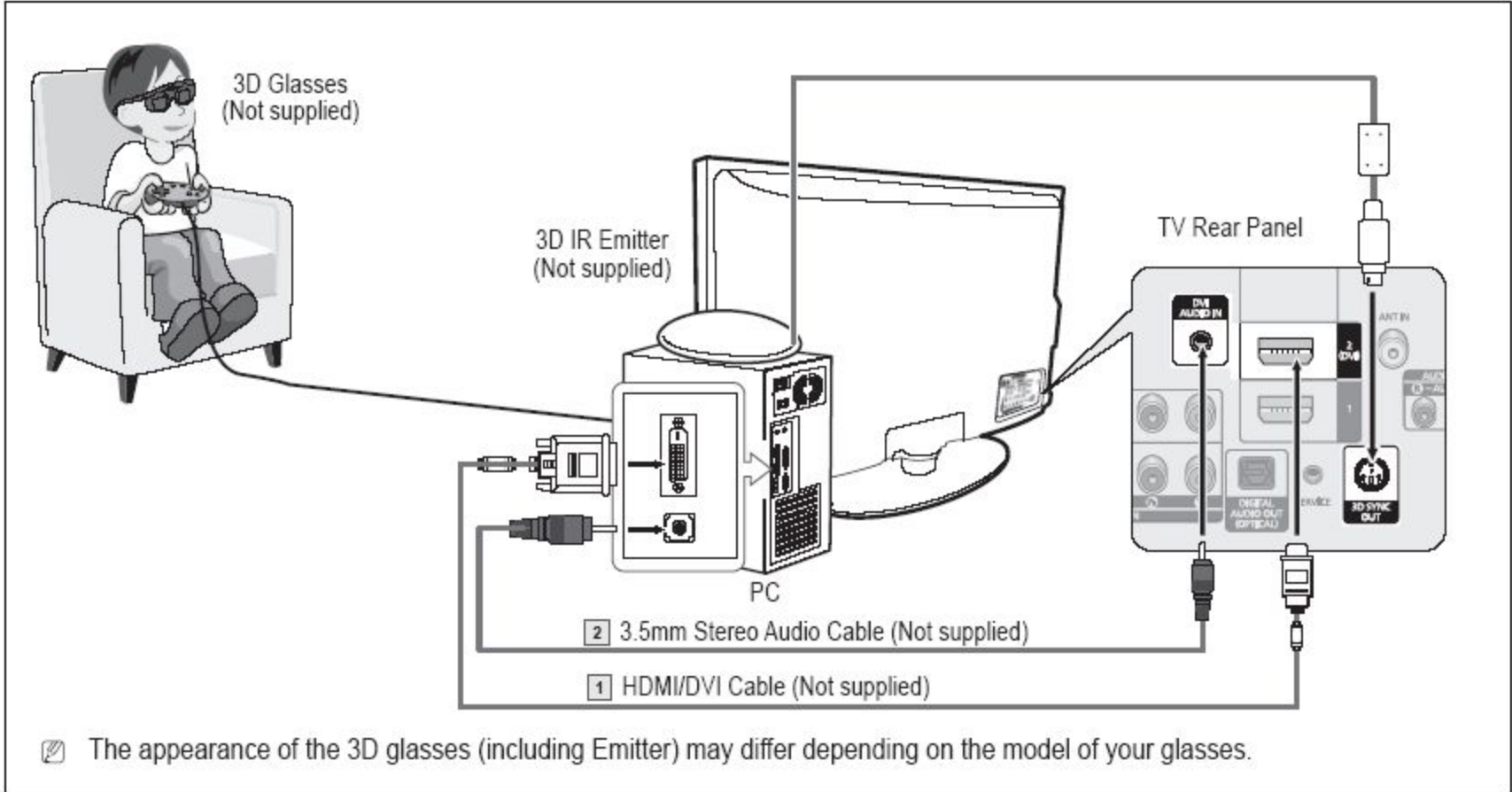

Figure-5. Measuring Area

PC timing

Mode	Resolution	Horizontal Frequency (kHz)	Vertical Frequency (Hz)	Pixel Clock Frequency (MHz)	Sync Polarity (H/V)	PS42B450B1D	PS50B450B1D
IBM	640 x 350	31.469	70.086	25.175	+ / -	✓	✓
	720 x 400	31.469	70.087	28.322	- / +	✓	✓
MAC	640 x 480	35.000	66.667	30.240	- / -	✓	✓
	832 x 624	49.726	74.551	57.284	- / -	✓	✓
VESA DMT	640 x 480	31.469	59.940	25.175	- / -	✓	✓
		37.861	72.809	31.500	- / -	✓	✓
		37.500	75.000	31.500	- / -	✓	✓
	800 x 600	37.879	60.317	40.000	+ / +	✓	✓
		48.077	72.188	50.000	+ / +	✓	✓
		46.875	75.000	49.500	+ / +	✓	✓
	1024 x 768	48.363	60.004	65.000	- / -	✓	✓
		56.476	70.069	75.000	- / -	✓	✓
		60.023	75.029	78.750	+ / +	✓	✓
	1360 x 768	47.712	60.015	85.500	+ / +		✓
VESA CVT	720 x 576	35.910	59.950	32.750	- / +	✓	✓
	1280 x 720	56.456	74.777	95.750	- / +		✓
		44.772	59.855	74.500	- / +		✓
VESA GTF	1280 x 720	52.500	70.000	89.040	- / +		✓

3D Function



1. Connect a HDMI/DVI cable between the HDMI IN 2(DVI) jack on the TV and the PC output jack on your computer.
 2. Connect a 3.5mm Stereo Audio Cable between the DVI AUDIO IN jack on the TV and the Audio Out jack of the sound card on your computer.
 3. Connect the Emitter to the 3D SYNC OUT port on the rear panel of the TV.
 4. Turn the TV on and set the source of the TV to HDMI2/DVI.
- ☑ For more information on the 3D glasses (including the Emitter), refer to the user manual of your 3D glasses.
 - ☑ **Adjust the PC resolution:**
 - PS42B450B1D : 1024 x 768@60Hz
 - PS50B450B1D : 1024 x 768@60Hz, 1360 x 768@60Hz
 - ☑ Optimum PC resolution for PS50B450 is 1360x768. When 1024x768 signal is connected in 3D mode, the picture will be shown in 4:3 format with left and right side grey bars appeared.
 - ☑ The 3D IR Emitter communicates with the 3D glasses.
Therefore, the 3D IR Emitter should be located near the 3D glasses.
 - ☑ It is activated when the HDMI or DVI input signal is RGB, and DVI Sound is supported.
 - ☑ When the power is turned on or off, the mode changes to the default (**Off**) and the **Format** is saved.
 - ☑ To use the 3D Effect function, a graphics card supporting 3D or 3D software is required.
 - ☑ The 3D glasses and the Emitter must be manufacturer by the same company.
 - ☑ If you play a game or watch TV while wearing the 3D glasses for long periods of time, you may experience eyestrain or a headache.
 - ☑ 3D glasses (including the Emitter) not manufactured by Samsung may not be supported.
 - ☑ If you find the screen flickering while the 3D function is used, change the environmental lighting darker or turn off the fluorescent lamp to watch the screen for its best condition.