

LARGE POLYMER CONVERTING INDUSTRIAL COMPLEX

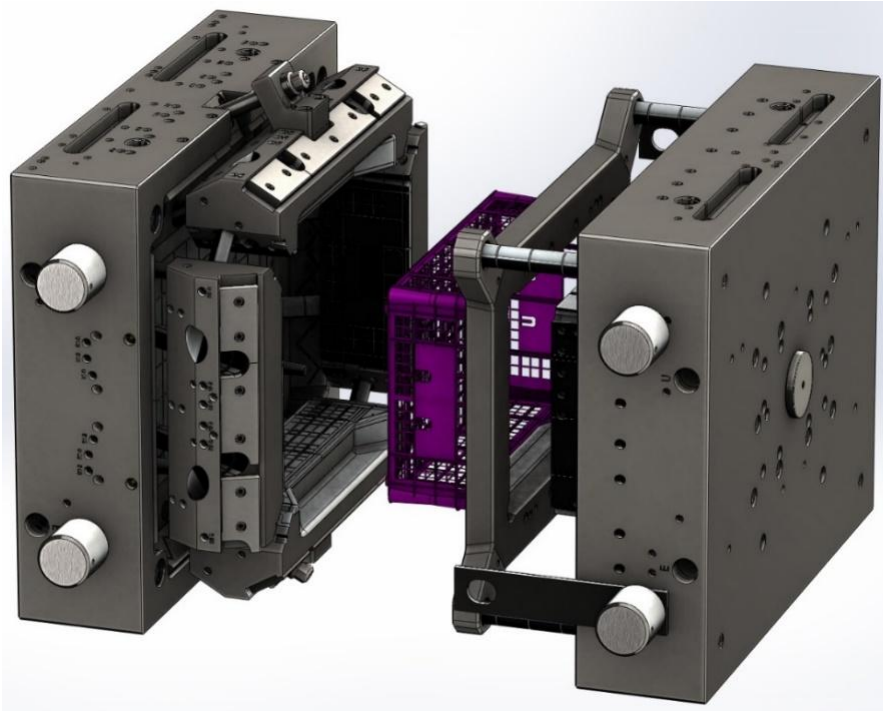



Purpose of the project :

Creation of modern innovative production at the site of the "Kulibin" Special Economic Zone (SEZ), aimed at import substitution, using the current competencies in the field a tool production.

Product:

- Process tooling, including large-sized, for injection molding of plastics
- Compression molds
- Extrusion tooling

Project objectives :

- Purchase of the necessary equipment.
- Site preparation for equipment installation.
- Equipment installation.

Prerequisites for successful project implementation :

- Lack of production of large-sized tooling in Russia
- Large volume of import of molds to Russia



TERRITORY OF THE NIZHNY NOVGOROD REGION

The Nizhny Novgorod Region is one of the largest regions of Russia, located in the central part of the East European Plain. It is part of the Volga Federal District, the administrative center of which is Nizhny Novgorod.



NIZHNY NOVGOROD
REGION

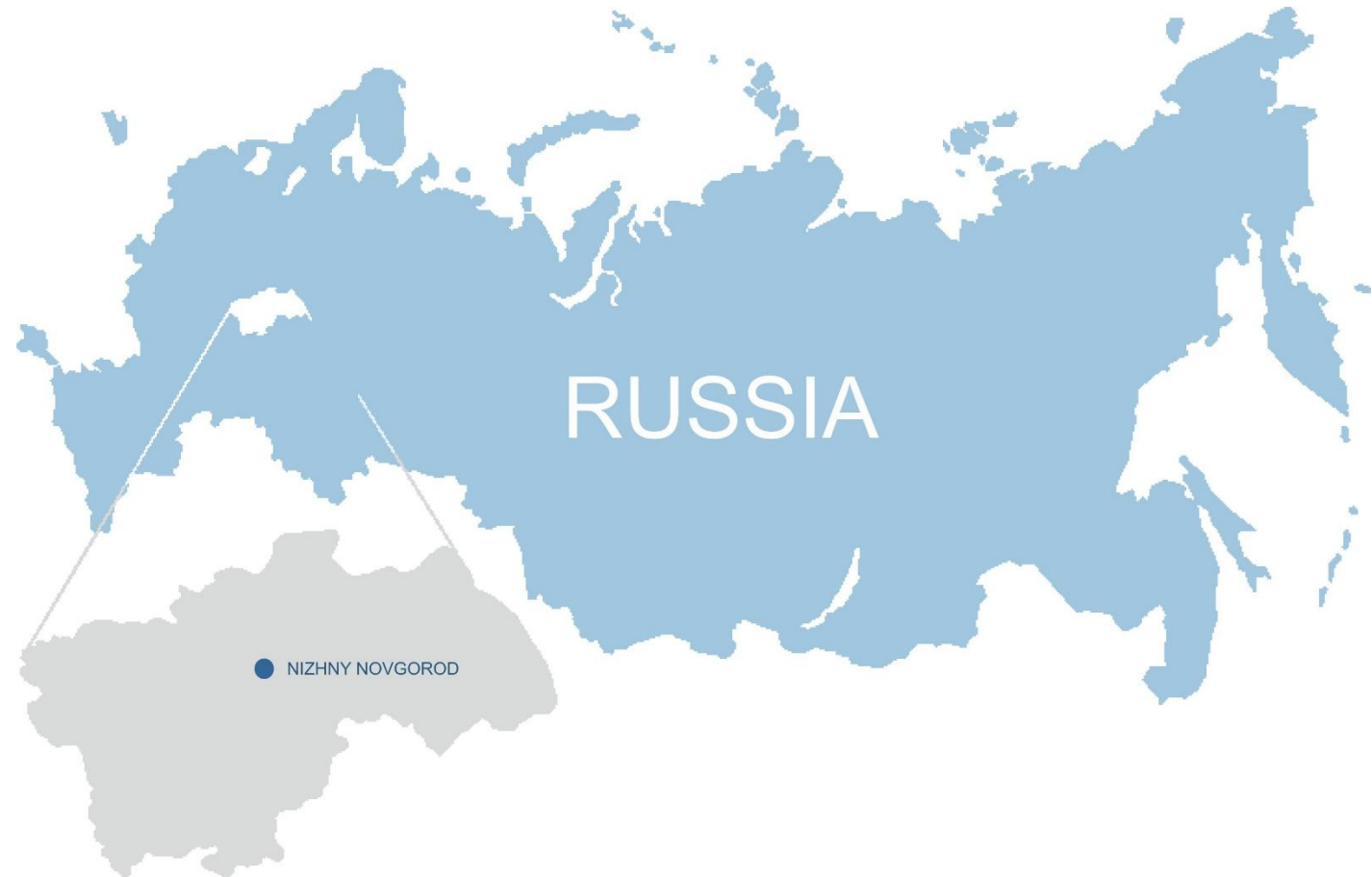



GEOGRAPHY OF THE TERRITORY OF THE NIZHNY NOVGOROD REGION

Center of the European part of Russia

Moscow - 400 km - Nizhny Novgorod



Eight cities with a population of over one million citizens within a radius of 1,000 km.



International transport corridors:
MTK No. 9 and **"North-South"**



Access to five seas: Caspian, Black, Azov, Baltic, and White Sea

POTENTIAL OF THE TERRITORY OF NIZHNY NOVGOROD REGION

STRUCTURE OF THE INDUSTRY

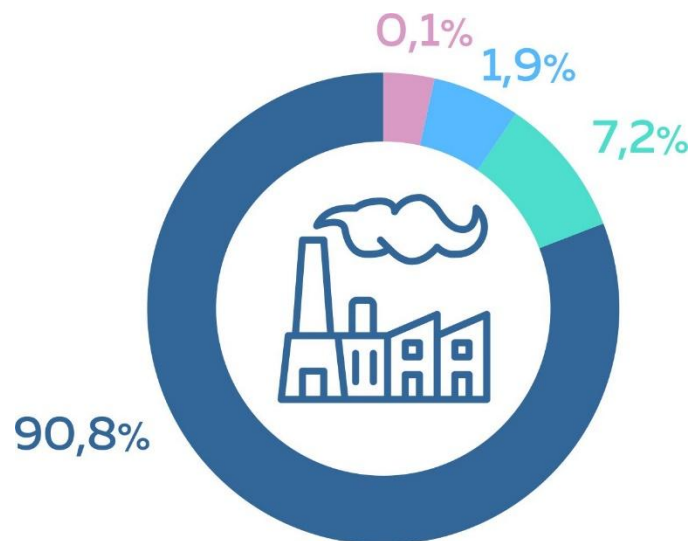

- Manufacturing industries - 90.8%
- Provision of electricity, gas and steam; air conditioning - 7.2%
- Water supply; wastewater disposal, waste collection and disposal, activities to eliminate pollution - 1.9%
- Mineral extraction - 0.1%

VOLUME OF INDUSTRIAL PRODUCTION

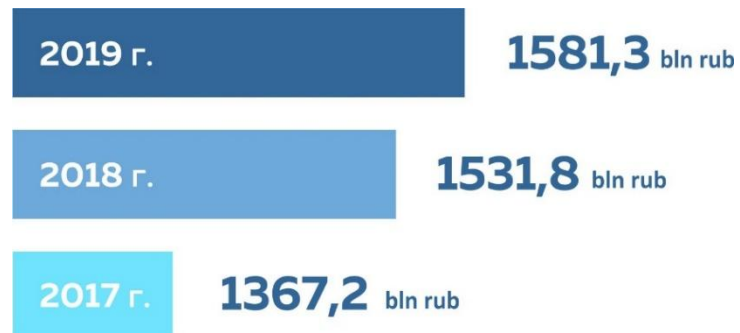

104.3%

The industrial production index off Nizhny Novgorod region is ahead of the national average.

102.3%

The industrial production index off Russia.

High scientific and technical potential



Availability of highly qualified personnel

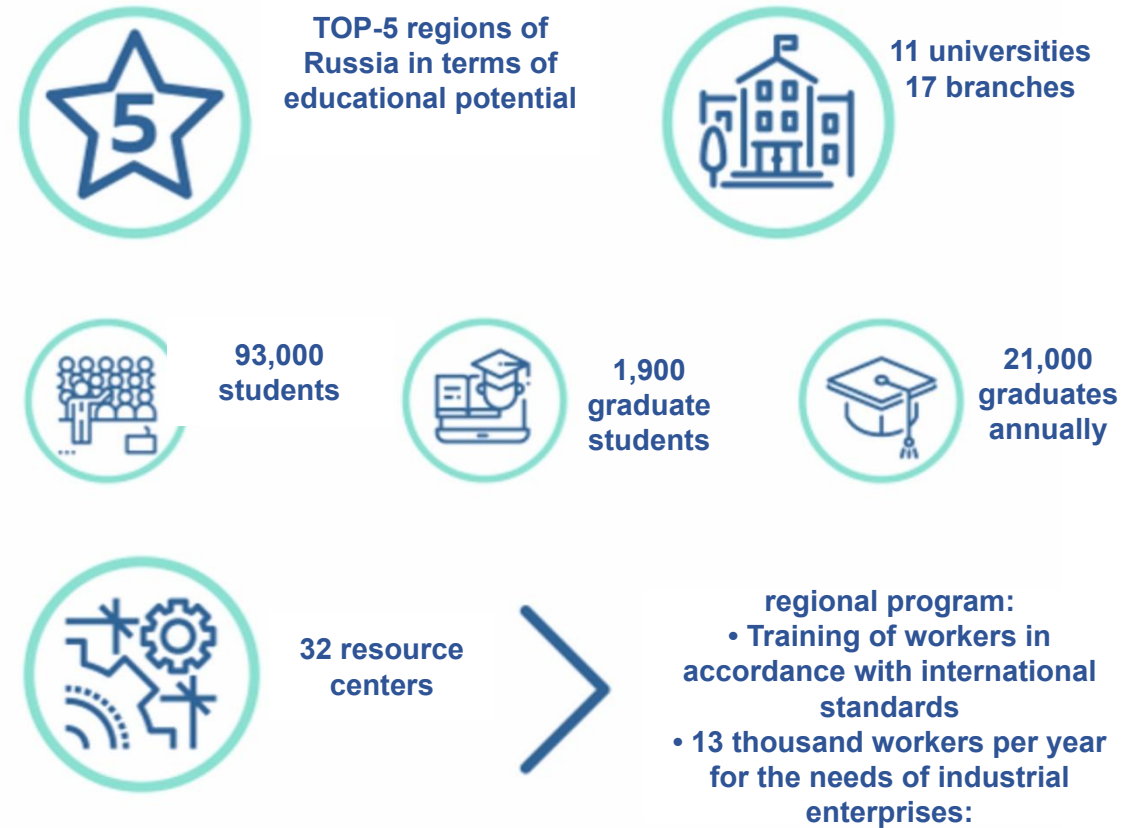



Kulibin

SPECIAL ECONOMIC ZONE

“Kulibin” industrial production type special economic zone in the Nizhny Novgorod region







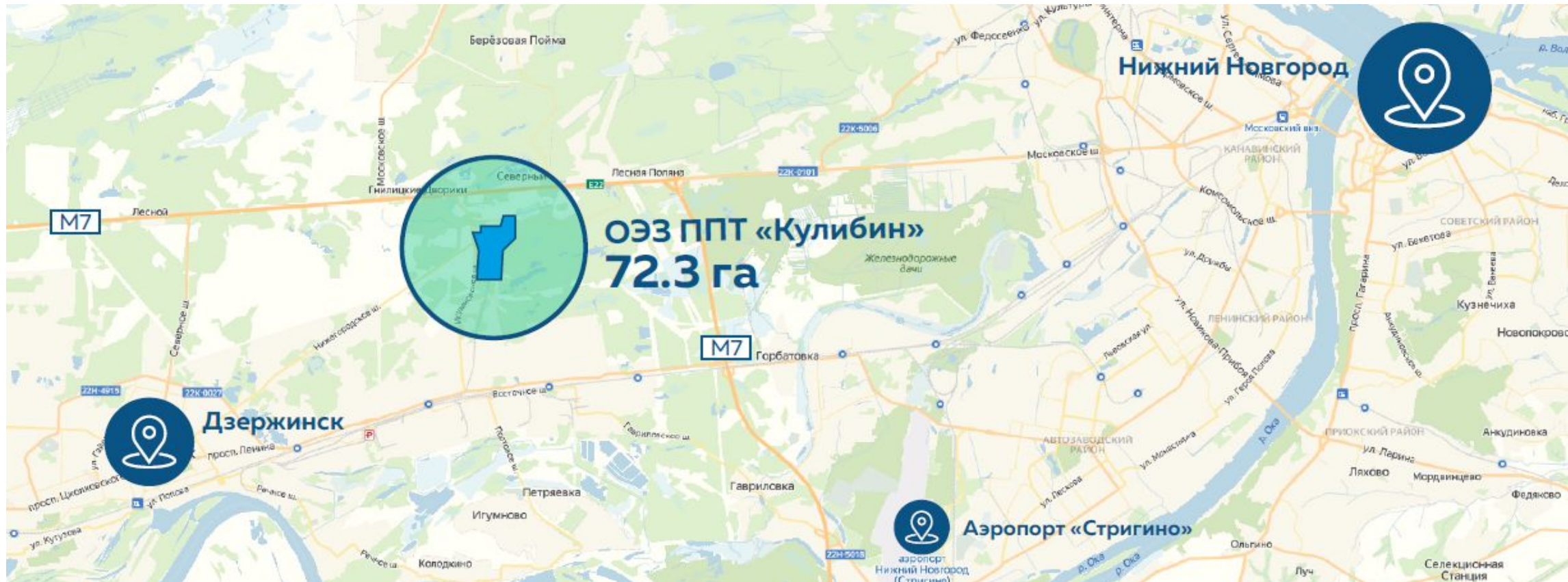

НИЖЕГОРОДСКАЯ
ОБЛАСТЬ



“KULIBIN” IPT SEZ. LOCATION



Priority areas of activity:

-  Manufacture of chemical products
-  Manufacture of pharmaceutical products
-  Manufacture of rubber and plastic products
-  Manufacture of composite products
-  Manufacture of automotive components
-  Allocation of logistics and warehouse complexes



“KULIBIN” IPT SEZ. SUPPORT MEASURES



SUPPORT MEASURES

types of taxes and fees

	1	2	3	4	5	6	7	8	9	10	20	30	40	50
Income	2%	2%	2%	2%	2%	5%	5%	5%	5%	5%	14,5%	14,5%	14,5%	14,5%
Property	0%	0%	0%	0%	0%	0%	0%	0%	0%	0%	standard rate – 20%			
Land property	0%	0%	0%	0%	0%	standard rate – average 1.5%								
Transport	0%	0%	0%	0%	0%	0%	0%	0%	0%	0%	standard rate – differentiated			

II-nd STAGE OF “KULIBIN” IPT SEZ (AVAILABLE FOR RESIDENTS IN 2022)

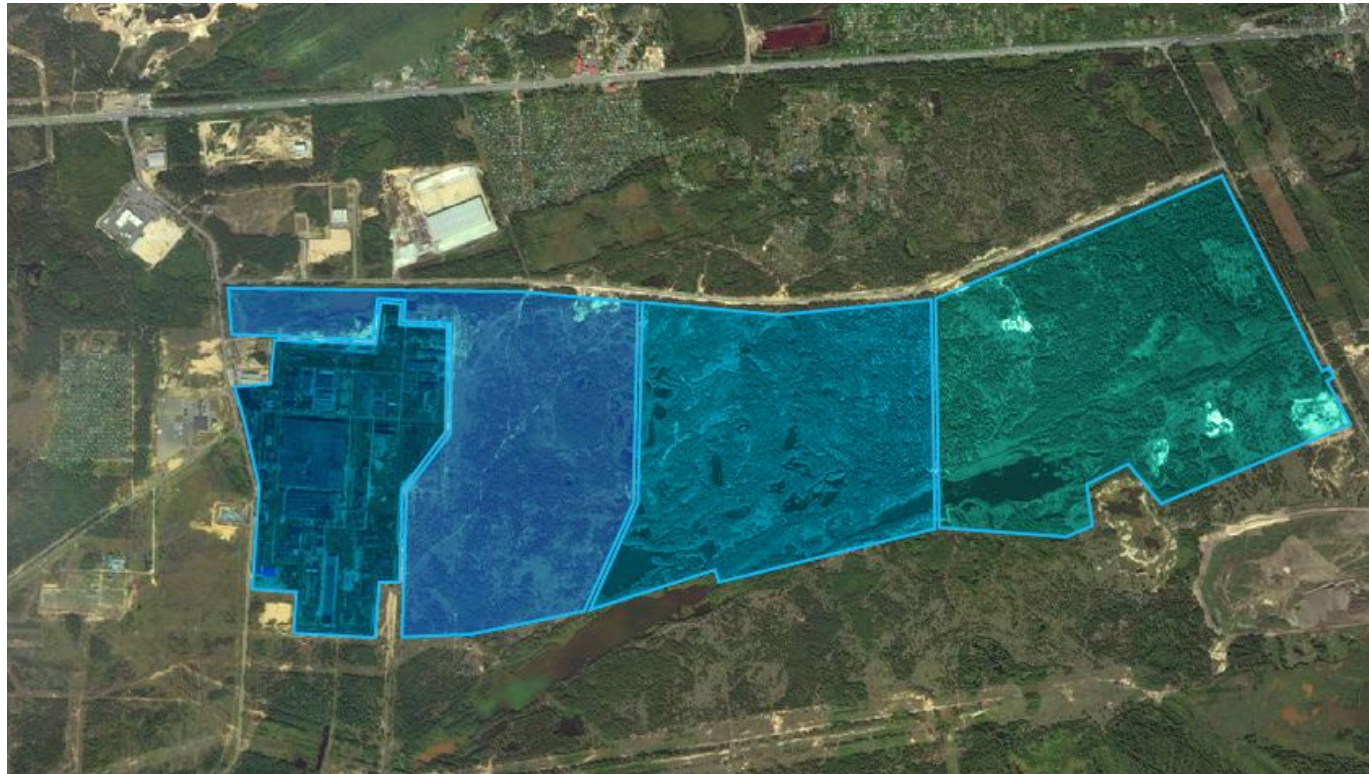

- “Kulibin” SEZ
S – 72,3 hectares
- 2-nd stage of development
S – 98.5 hectares
- 3-rd stage of development
S – 150 hectares
- 4-th stage of development
S – 180 hectares



ABOUT THE ENTERPRISE

JSC “DPO “Plastik” is fully provided with energy resources, the company has an in-house repair shop, warehouses and an extensive network of access roads.

The area of the enterprise is 75 hectares. The number of employees is more than 1,000 people.

The structure of the company includes 7 production departments:



- Polyethylene film
- Rigid PVC films
- Injection molded products
- Compression molded products
- Extrusion products
- Fiberglass products



COMPETENCES of JSC DPO PLASTIK

Experience in tool production and production of injection molded products for various industries:

- Automotive components
- Polymer pallets, containers and boxes
- Garbage containers
- Elements of water collection and drainage systems
- Consumer goods



Schoeller Allibert





INJECTION MOLDING PRODUCTION FACILITY

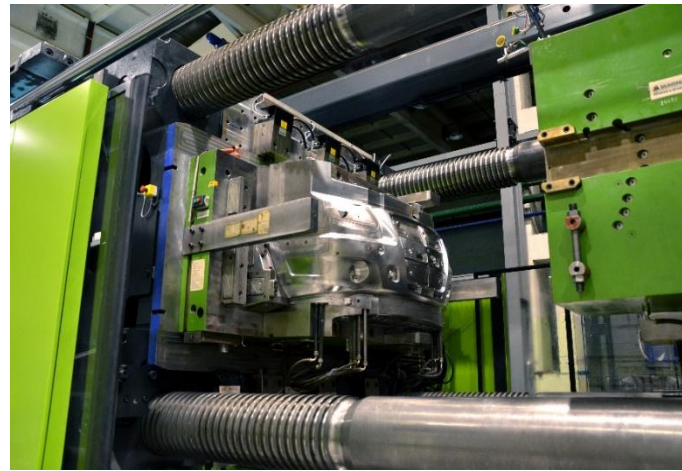

The production facility of injection molded products has a unique production base for the processing and manufacture of plastic products. All injection molding machines (IMMs) are fully robotic:

- 18 IMMs from 28 up to 580 tons
- 8 IMMs from 650 up to 3,200 tons



In 2020, the equipment park was supplemented with IMMs with clamping forces of

- 1600 t
- 2100 t
- 3300 t



EXISTING TOOL PRODUCTION FACILITY



- JSC DPO Plastik possesses significant experience in tool production for the development, manufacture and repair of the necessary process equipment.
- The available equipment (EDM machines, milling machining centers and other CNC machines) allow us to repair compression and injection molds, extrusion equipment, fixtures, non-standard equipment and tools of varying degrees of complexity.



IMPORT OF THE MOLDS TO 2019

Import of molds to Russia in 2019 in the amount of 4 bln rub

Structure of import of molds to Russia in 2019,%, rubles

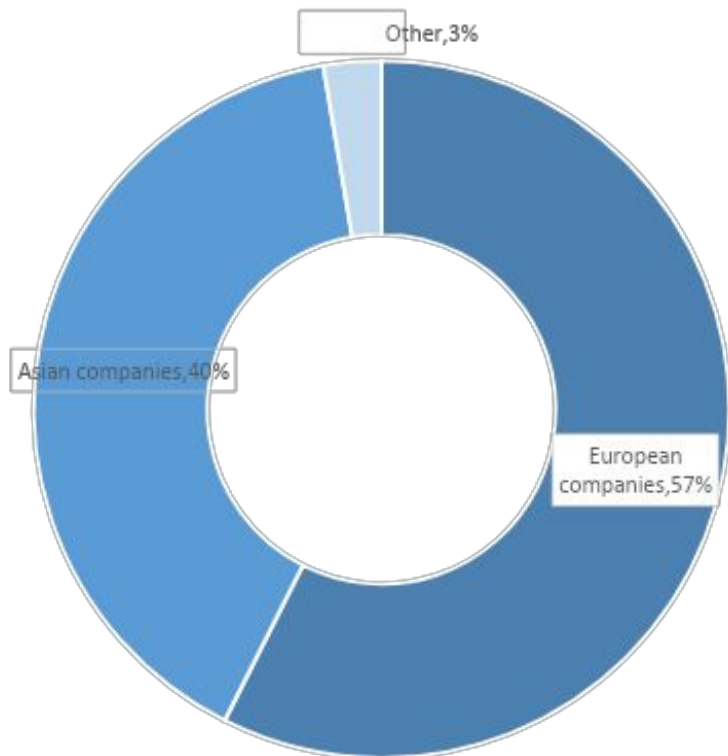

JSC DPO Plastik has experience of cooperation with some of the largest mold manufacturing companies.

The largest importers in 2019



Name	Country
Zhejiang Kaihua Moulds Co.,Ltd.	China
OTTO HOFSTETTER AG	Switzerland
Zhejiang Taizhou Meiduo Mould Co.	China
MD MOLDES	Portugal
FCPK BYTOW SP.ZO.O.	Poland
SUM HING	Malaysia
Shenzhen HuaYiSheng Mould Co., Ltd	China
Haidlmair Gmbh Werkzeugbau	Austria
Moliporex, S.A.	Portugal
HMC	Korea
Hasco Hasenclever Gmbh + Co Kg	Germany
Fodesco	Finland
Asg Moldes	Portugal



PRODUCTION SITE IN THE AREA OF “KULIBIN” SEZ

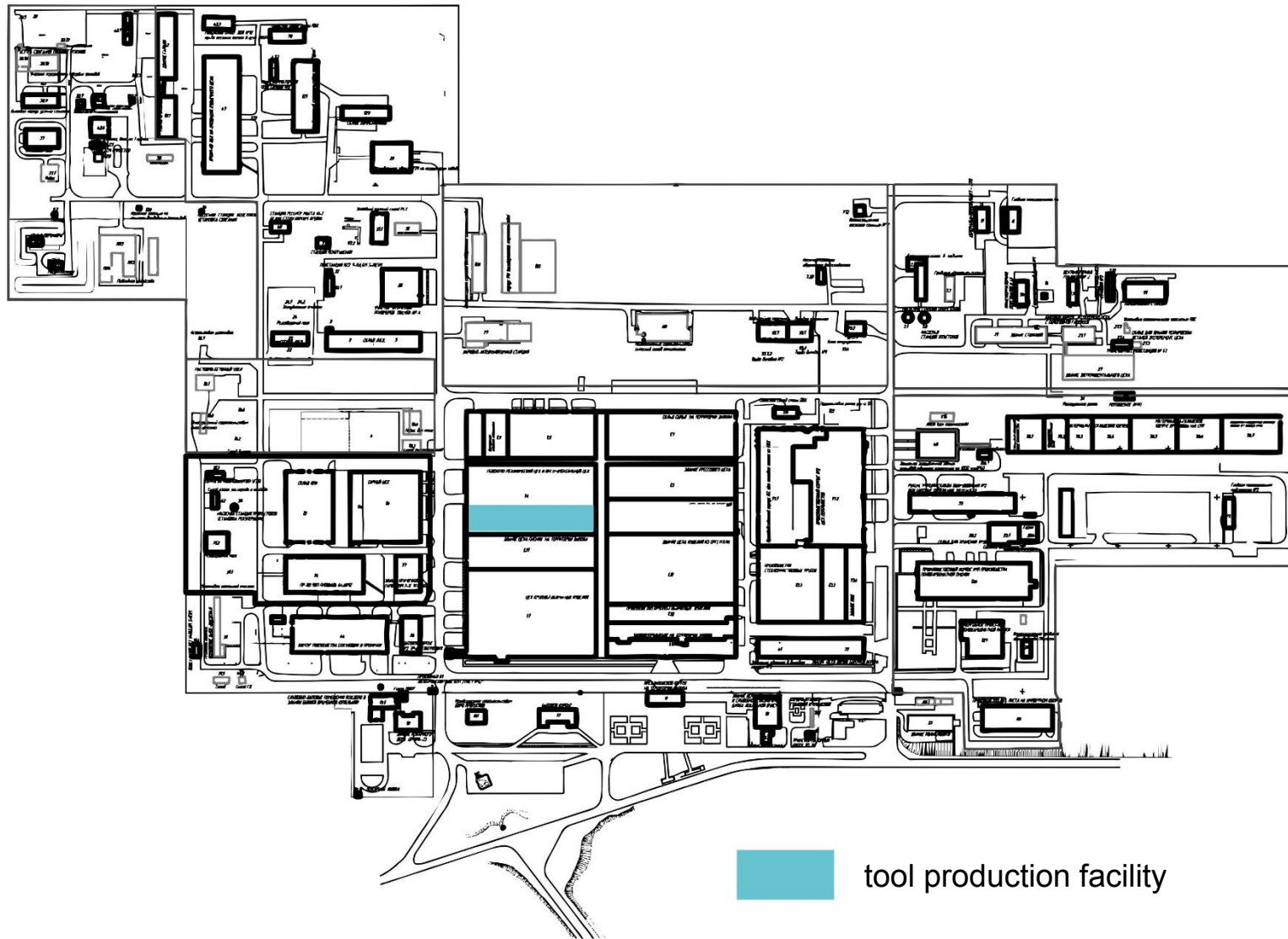

- Possibility of allocation of a **large-sized equipment**.
- Bridge crane with a lifting capacity of **50 tons**;
- All necessary **communications**;
- Availability of **galvanic and thermal** department in the production facility.

FLOW CHART - PROPOSED TOOLING PRODUCTION FACILITY

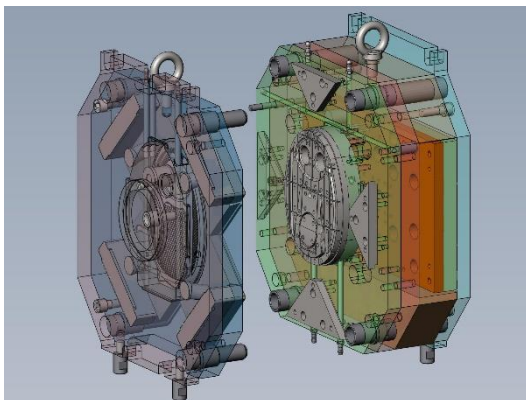
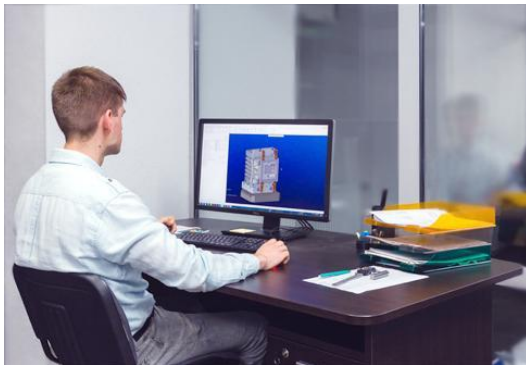

- **Administration**
- **Designers**
- **Section of CNC machines**
- **Section for processing the parts and equipment assembly**
- **Mechanical section**
- **Tooling service area**
- **Repair team**

THANK YOU FOR YOUR ATTENTION!



WWW.DPLAST.RU

8 800 550 09 05

15a Igumnovskoe highway, Dzerzhinsk, Nizhny Novgorod region,
606000, Russia

