

Bobcat ATTACHMENTS

LANDSCAPING SOLUTIONS

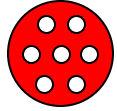



Attachment requires electrical control kit installed on the loader



Attachment requires drain line



Attachment requires loader with high flow



Attachment will have higher performance when working on loader with high flow



Attachment works with standard flow only

- **Mower**
- **Brushcat Rotary Cutter**
- **Flail Cutter**
- **Forestry Cutter**
- **Wood Chipper**
- **Stump Grinder**
- **Combination Bucket**
- **Dozer Blade**
- **Fork & Bucket Grapple**

- **Mower**
- **Brushcat Rotary Cutter**
- **Flail Cutter**
- **Forestry Cutter**
- Wood Chipper
- Stump Grinder
- Combination Bucket
- Dozer Blade
- Fork & Bucket Grapple

Land Clearing Applications



FLAIL CUTTER Heavy Duty



FORESTRY CUTTER



ROTARY CUTTER Medium Duty



MOWER Light Duty

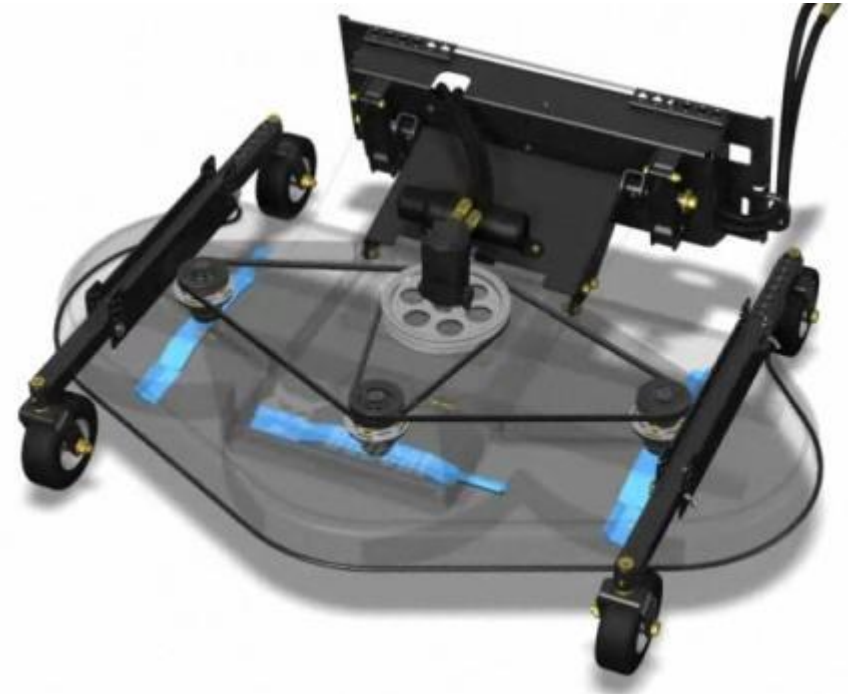

Mower 72" S100 S330, A300, T140 T190

Mower 90" S150 S330, A300, T140 T190

ROTARY CUTTER Medium Duty Applications



s h H



Rotary Cutter 60", **two models RC60S and RC60H**
Standard Flow and High Flow versions

Rotary Cutter 72", **three models RC72S, RC72H and RC72X**
Standard Flow and High Flow versions

- **RC60S Standard Flow (57-83 l/min)**
 - S150, S160, S175, S185, S205, S220, S250, S300, S330, A300, T190, T250, T300, T320
- **RC60H High Flow (76-121 l/min)**
 - S160H, S175H, S185H, S205H, S220, S250, S300, S330, A300, T190H, T250, T300, T320
- **RC72S Standard Flow (57-83 l/min)**
 - S175, S185, S205, S220, S250, S300, S330, A300, T190, T250, T300, T320
- **RC72H High Flow (76-121 l/min)**
 - S175H, S185H, S205H, S220, S220H(*), S250, S250H(*), S300, S300H(*), S330, A300, A300H(*), T190H, T250, T250H(*), T300, T300H(*), T320, T320H(*)
 - (*) not approved for use on 151 l/min high flow loaders.
- **RC72X X-High Flow (114-151 l/min)**
 - S220H, S250H, S300H, S330H, A300H, T250H, T300H, T320H

FLAIL CUTTER Heavy Duty Applications



FLAIL CUTTER Heavy Duty Applications

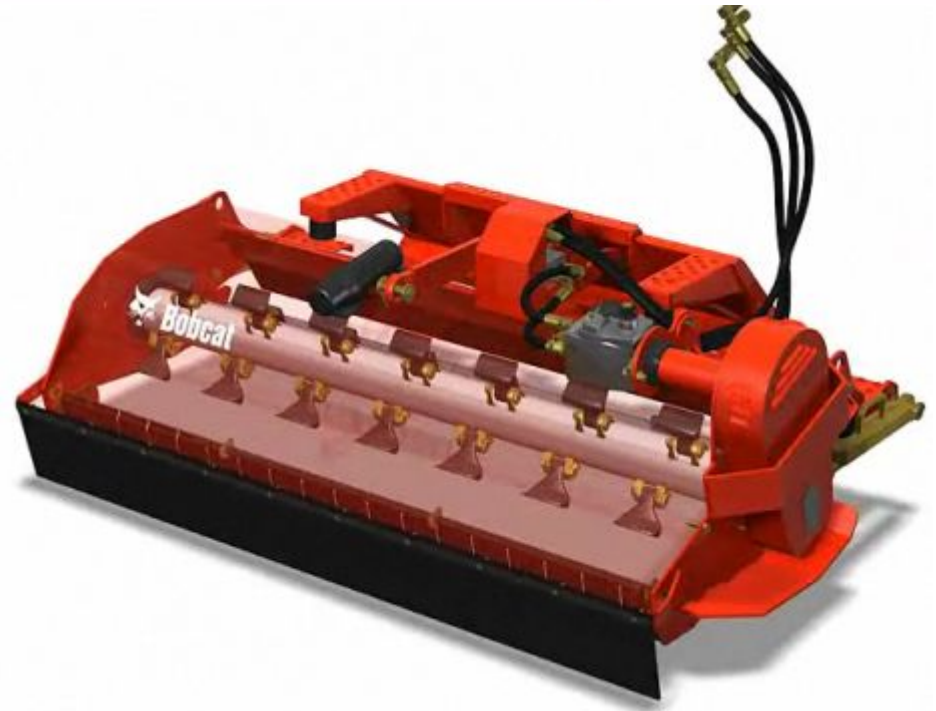

Flail Cutter FC155 S130 S205, T140 T190

Flail Cutter FC175 S175 S330, A300, T190 T320

Flail Cutter FC200 S175 S330, A300, T190 T320



Exclusive Bob-Tach mounting device (patented)

The exclusive Bob-Tach mounting device features a host of improvements that greatly simplify using the flail mower on virtually any kind of terrain.



Axial piston motor

The adjustable swash plate allows the user to accurately adjust the motor speed (and thus the flail shaft speed) according to the oil flow present in the carrier.

MAX. 2200 RPM

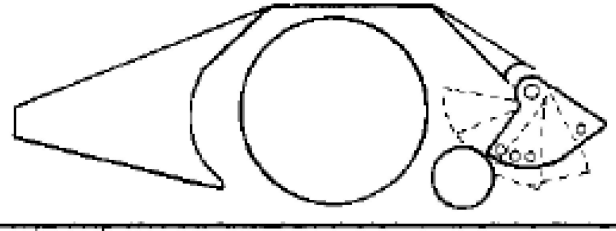

Adjustable mulch hood

The mower has been equipped with a mulch hood, situated at the rear of the frame, above the roller.

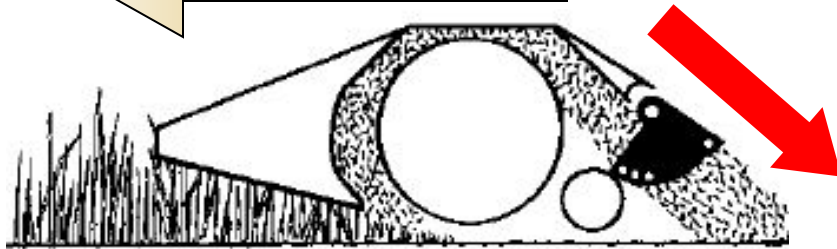

Fully open position

This position allows optimal cutting when moving forward at high speeds, reducing fuel consumption and hydraulic power requirements.

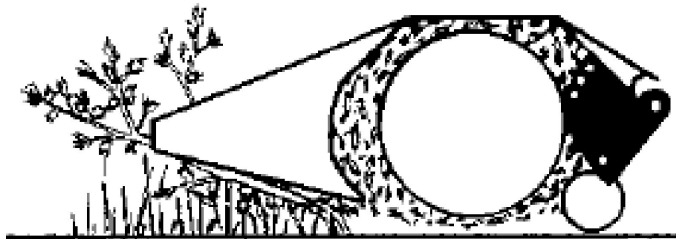

When the rear cover is fully open, the material being cut is ejected via the flail mower roller.

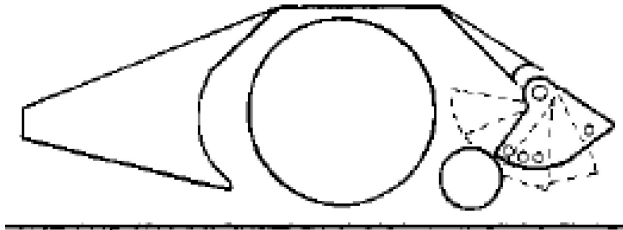

Adjustable mulch hood

The mower has been equipped with a mulch hood, situated at the rear of the frame, above the roller.

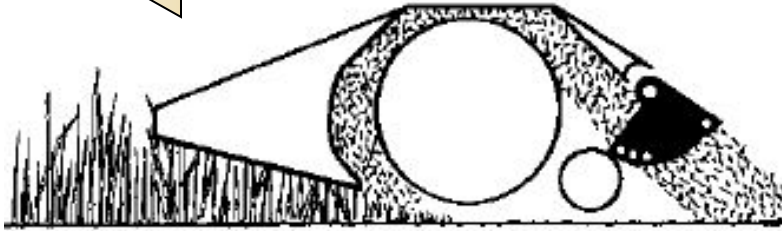

Fully closed position

This position is typically used for processing pruning waste into mulch or when fine-grade, homogeneous mulch is needed. The material to be mulched is milled between the rotor and roller when the rear cover is in the fully closed position.

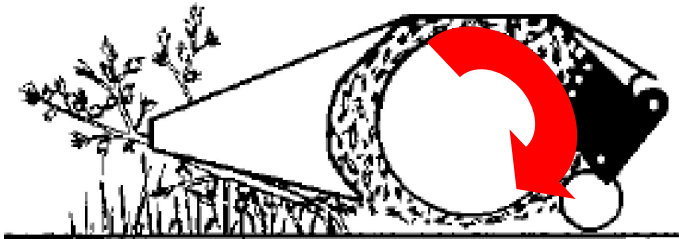

FORESTRY CUTTER



Forestry Cutter FRC150 and Forestry Application Kit



AGRICULTURE

- Vineyards / Orchards
- Nurseries / Tree Care

BUILDINGS / GROUNDS

- Perimeter maintenance of facilities
- Wildlife and outdoor management

CONSTRUCTION

- Site development

LANDSCAPING

- Land clearing
- Areas of greenspace

MAINTENANCE Right-of-Way

- Utilities
- Railroad
- Highway

GOVERNMENT / INSTITUTES

- Military Bases
- National Parks

FORESTRY

- Forestry services
- Fire breaks
- Forestry clearing
- Remove undergrowth
- Remove unwanted trees



Bobcat can provide you with
a **complete system** :

Bobcat Loader □ with adequate hydraulic horsepower

Forestry Applications Kit □ to protect operator and machine

Forestry Cutter Attachment □ with its unique and durable design to withstand extreme working conditions

FORESTRY CUTTER : Quick Specs



Overall width : 1834 mm

Cutting width : 1500 mm

Operating weight : 1265 kg

Number of teeth : 24

Tree diameter

- **Continuous :** 10-12 cm
- **Intermittent :** 18-22 cm

Approved carriers : **S300H, S330H, A300H, T250H, T300H, T320H**



Note : **CARRIER MUST BE EQUIPPED WITH THE FORESTRY APPLICATION KIT**



The **tube-style drum** has 24 fixed twin-teeth, they provide faster production and a smooth cut.

Teeth are mounted with a **spiral pattern**, this allows one tooth to engage at a time, contributing to a smooth cut increasing operator comfort and at the same time requiring less hydraulic horsepower.

The **drum brake** stops the drum from full speed in approximately 10 seconds, resulting in additional safety.



Creating fine mulch

The skid shoes should be parallel with the ground and slightly elevated. In this position material will be thrown against the counter combs reducing the chips' size. The lift arms can be lowered to till into the soil – this process is very HP intensive, so use it only if necessary. Closing the front gate will help retain material.

- Mower
- Brushcat Rotary Cutter
- Flail Cutter
- Forestry Cutter
- **Wood Chipper**
- Stump Grinder
- Combination Bucket
- Dozer Blade
- Fork & Bucket Grapple

WOOD CHIPPER



WOOD CHIPPER : Quick Specs



Model : 8B

Operating weight : 753 kg

Feeder opening : 230 mm

Branch diameter

- **Continuous :** up to 130 mm

Blades : 4 reversible

Approved carriers : S160H □ S330H, A300H, T190H □ T320H



Eliminate tree limbs, branches and other debris quickly, safely and easily with the Bobcat chipper attachment

Reduces branch volume 10 to 1

Chipper 8B



Bobcat Remote Attachment Control (RAC) system - This system allows the operator to start or stop the loader's engine and chipper rotation when standing beside the attachment.

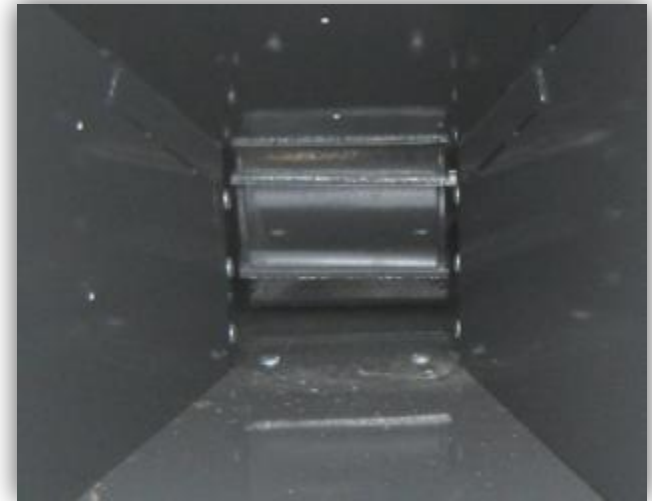

- **Automatic hydraulic feeder with load sensing system**
- **Feed roller speed control**
- **Reversible direction feed roller**



Reversible and replaceable cutters



- **360° discharge chute with adjustable deflector**
- **Dual mounting locations which allow material to be fed from the front or right side of the loader**

- Mower
- Brushcat Rotary Cutter
- Flail Cutter
- Forestry Cutter
- Wood Chipper
- **Stump Grinder**
- Combination Bucket
- Dozer Blade
- Fork & Bucket Grapple

STUMP GRINDER





Bobcat stump grinders are powerful grinding attachments that make fast work of **removing entire tree stumps without repositioning.**

Models : SG30, SG60 and SGX60

STUMP GRINDER : Models



SG30
Small loaders



SG60 and SGX60
Medium and large loaders

SG60, SGX60 can grind stumps of 1.10 m diameter without repositioning.



SG60 versus SGX60

SG60 and SGX60 have approx. the same RPM and work at the same pressure.

SGX60 has a **larger displacement motor** for **additional torque** to the cutting wheel, as well as a new valve package to accommodate the higher hydraulic flow capacity of machines.

SGX60 for High Flow loaders only.

- Mower
- Brushcat Rotary Cutter
- Flail Cutter
- Forestry Cutter
- Wood Chipper
- Stump Grinder
- **Combination Bucket**
- Dozer Blade
- Fork & Bucket Grapple

COMBINATION BUCKET



COMBINATION BUCKET



Sizes

44"

62"

68"

74"

80"

84"

Also referred to as : Multi-Purpose Bucket or 4-in-1 Bucket

COMBINATION BUCKET

- **Most versatile bucket in the range**
- **Designed for :**
 - **Dozing**
 - **Digging**
 - **Grappling**
 - **Loading**
 - **Dumping**
 - **Levelling**
 - **Scraping**

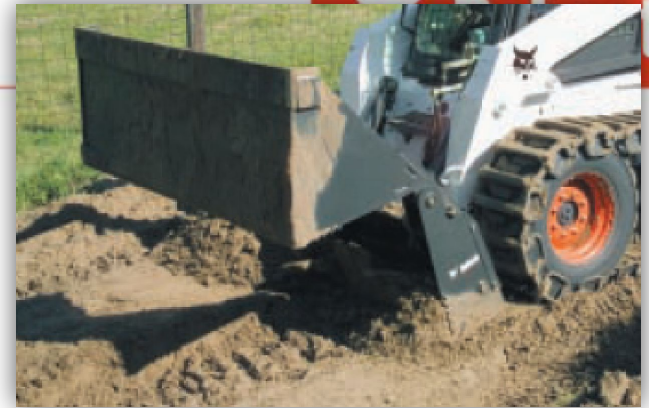



Interlocking serrated grapple edges hold objects securely – even heavy or oddly-shaped materials.



Increased dumping height.

Opening the clamshell spreads material evenly and provides a height advantage for loading trucks without tipping the bucket.

- Mower
- Brushcat Rotary Cutter
- Flail Cutter
- Forestry Cutter
- Wood Chipper
- Stump Grinder
- Combination Bucket
- **Dozer Blade**
- Fork & Bucket Grapple

DOZER BLADE





48" model : also referred to as **Utility Blades**

30° left/right angle – no oscillation

68", 80", 90", 96" models : also referred to as **6-way Dozer Blades**

30° left/right angle and 8° left/right oscillation



Turn your loader into a mini crawler with a Bobcat dozer blade.

The dozer attachment is ideally suited for levelling, piling or grading loose dirt, gravel or sand.

Use it to backfill around foundations, fill trenches, create run-off grades and sculpt landscape areas.



Snow blades have :
One hydraulic function, blade angle left/right
Optional rubber / PU cutting edges and end wings
Trip springs for component and operator protection



- Mower
- Brushcat Rotary Cutter
- Flail Cutter
- Forestry Cutter
- Wood Chipper
- Stump Grinder
- Combination Bucket
- Dozer Blade
- **Fork & Bucket Grapple**

- **Farm/Utility Grapple**

- Light/Medium Duty
- Ag Market
- Landscaping



- **Industrial Grapple**

- Heavy Duty
- Ag Market
- Landscaping
- INDUSTRY



Farm / Utility Grapple



**Utility FORKS 36", 48", 54"
+ 32" Farm GRAPPLE**

**Utility FORKS 60", 66", 72"
+ 55" Utility GRAPPLE**



**General Purpose BUCKET 36", 48", 50", 56"
+ 32" Farm GRAPPLE**

**General Purpose BUCKET 62", 68", 74"
+ 55" Utility GRAPPLE**



Farm / Utility Grapple

Applications : Light and Medium Duty



Landscaping



Ag



Renovation



Industrial Grapple



- **Move hard to handle materials easily**
- **Hydraulically controlled grapple is easy to operate**
- **Handles bulky, uneven loads securely**

Industrial Bucket Grapple



- 60" Bucket Grapple
- 66" Bucket Grapple
- 72" Bucket Grapple
- 80" Bucket Grapple



It's recommended to install a **port relief valve** on the loader for use with industrial grapples. Optional **open/close restrictor** is available to slow down open/close functions.



- **66" Fork Grapple**
 - Std with 7 teeth
 - Max. 13 teeth
- **78" Fork Grapple**
 - Std with 8 teeth
 - Max. 15 teeth

It's recommended to install a **port relief valve** on the loader for use with industrial grapples. Optional **open/close restrictor** is available to slow down open/close functions.