

**МАТЕРИАЛЫ  
И ИЗДЕЛИЯ  
ИЗ ДРЕВЕСИНЫ**

**ЛЕСОМАТЕРИАЛ  
Ы  
И ИЗДЕЛИЯ ИЗ  
НИХ**

# Рубленое бревно



# Оцилиндрованное бревно



# Брусья и бруски



# Доска (обрезная)



# Доски шпунтованные



# Доски фальцованные

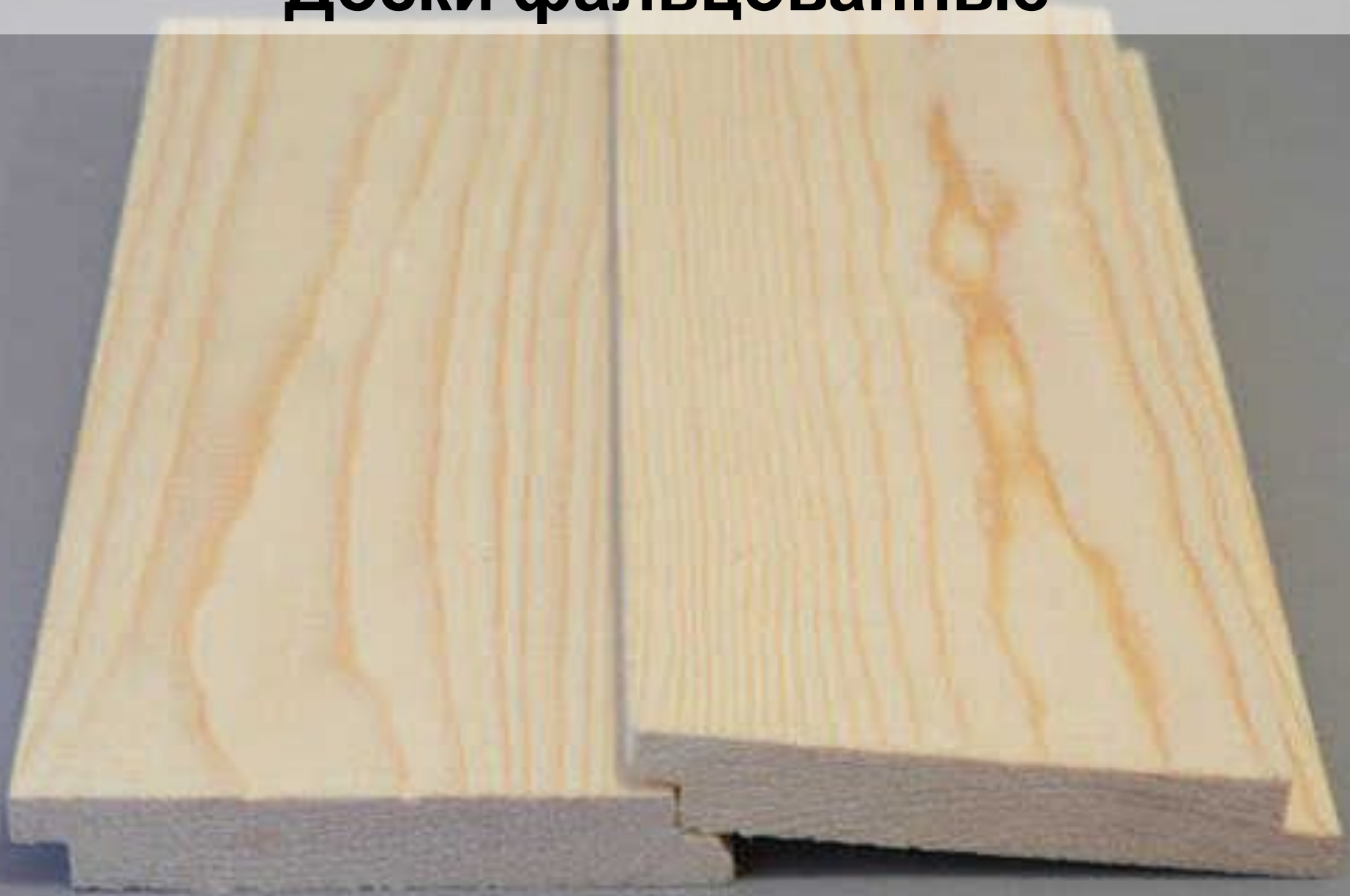



# Вагонка



# Штучный паркет



# Фрезерованные изделия



**Шпон**



# Кровельная плитка и гонт



# Лемех



# Кровельная дрань



# Кровельная щепа





# Дрань штукатурная



**КЛЕЕНЫЕ  
МАТЕРИАЛЫ  
И ИЗДЕЛИЯ**

# Фанера обычная

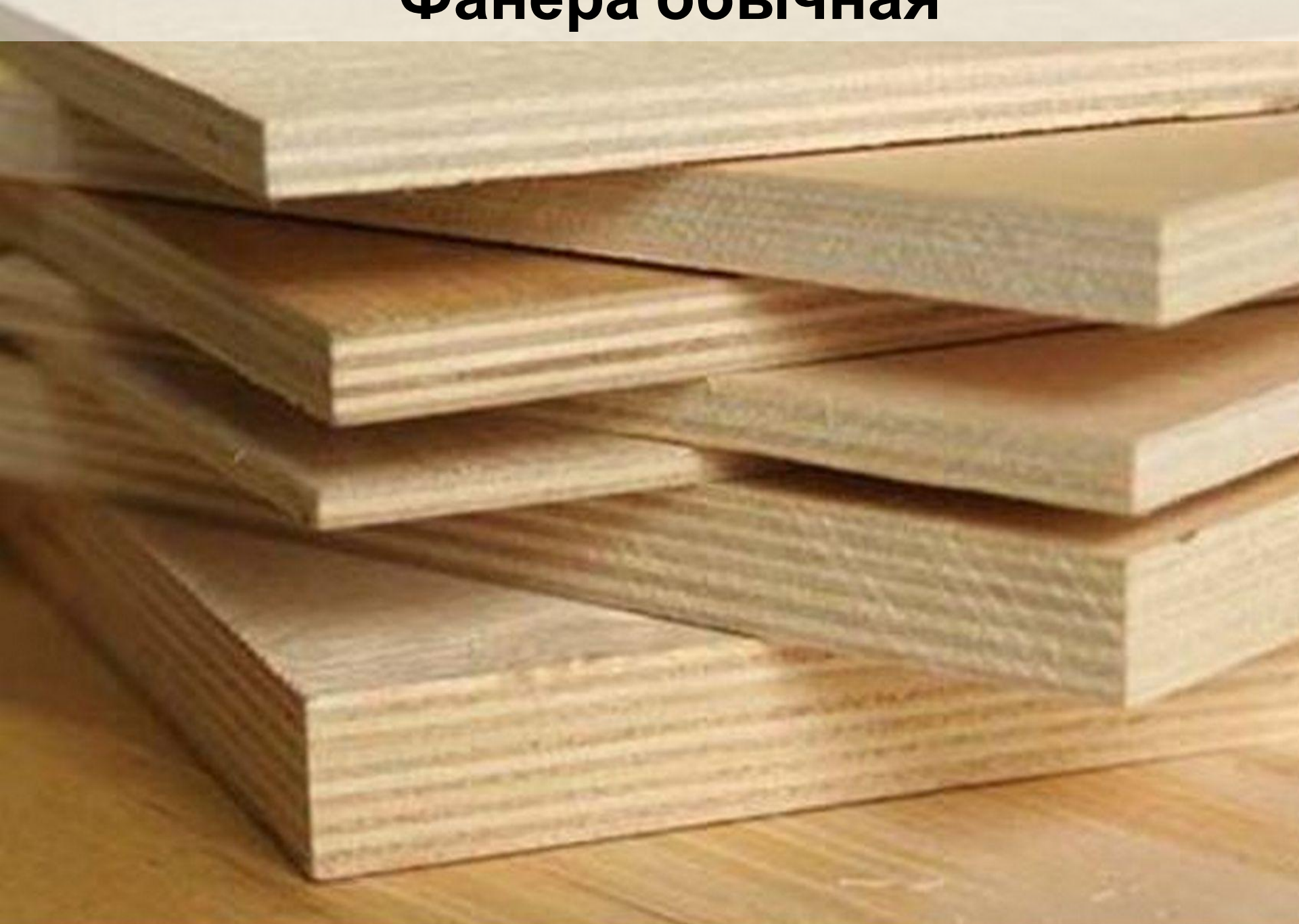



# Фанера декоративная (ламинированная)

# Брус LVL

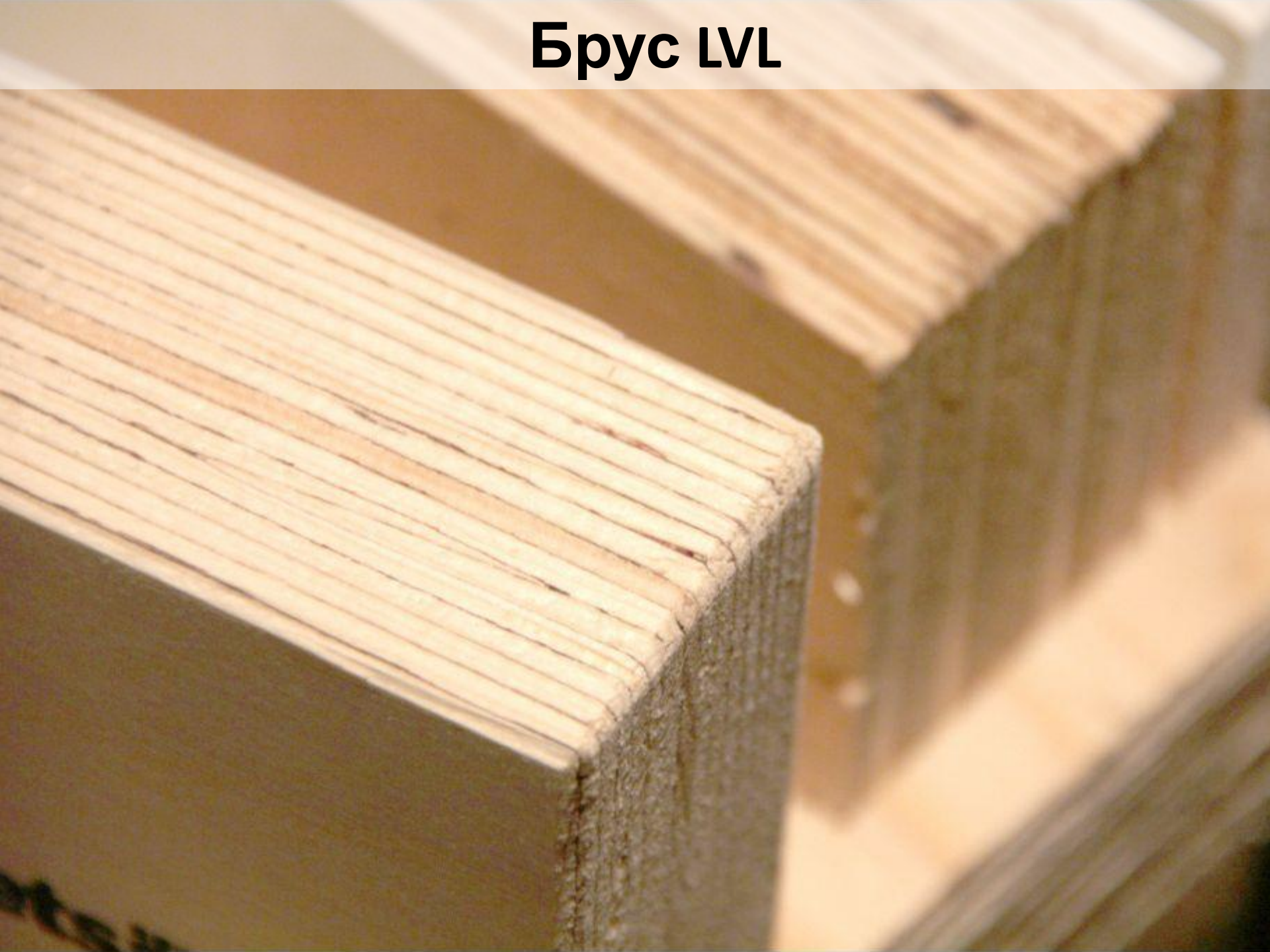

# Клееный брус



# Столярные плиты



# Паркетная доска





# Щитовой паркет



# **МАТЕРИАЛЫ ИЗ ОТХОДОВ ДРЕВЕСИНЫ**

**Древесноволокнистая плита (ДВП),  
мягкая**



**Древесноволокнистая плита (ДВП),  
твердая**

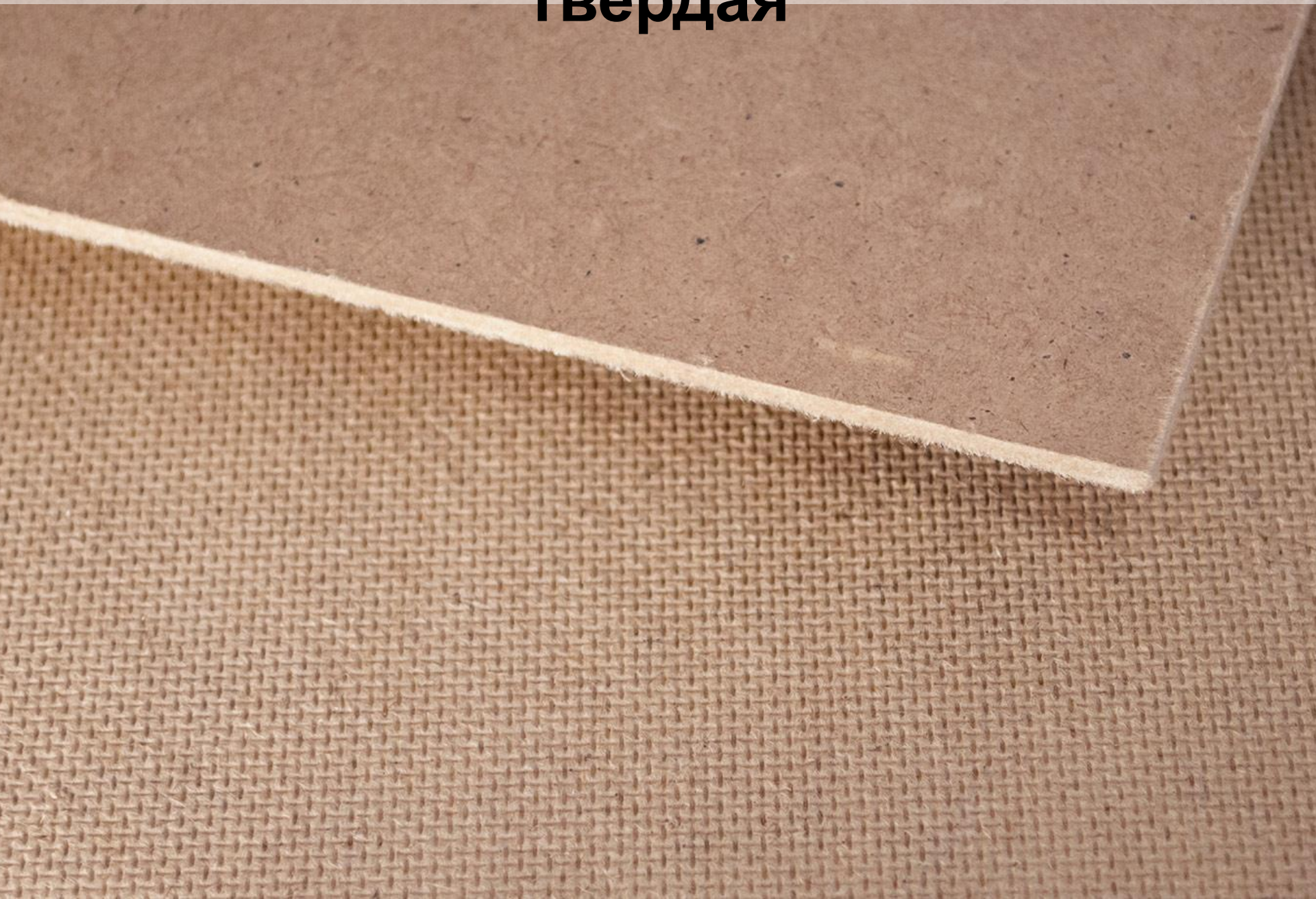

# Оргалит (ламинированная ДВП)



# Ламинат



# Древесноволокнистая плита (МДФ)



# Древесно-стружечная плита (ДСП)





# Ламинированная ДСП (ЛДСП)



# Ориентированно-стружечная плита (ОСБ)



**ДЕРЕВА  
ПРИ  
ВОЗВЕДЕНИИ  
НЕСУЩИХ  
ОСТОВОВ  
ЗДАНИЙ**



**Бревенчатые рубленые дома**



# Дома из бруса





# Каркасные дома



















<http://stroidoms.tiu.ru>

# Щитовые дома







# Панельные дома









# **ДЕРЕВЯННЫЕ КЛЕЕННЫЕ КОНСТРУКЦИИ**

**БАЛКИ**

# Деревянные балки и фермы

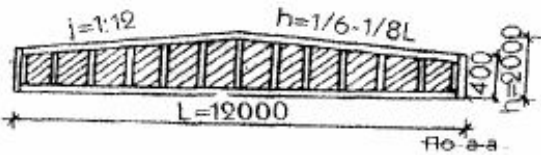

**а**

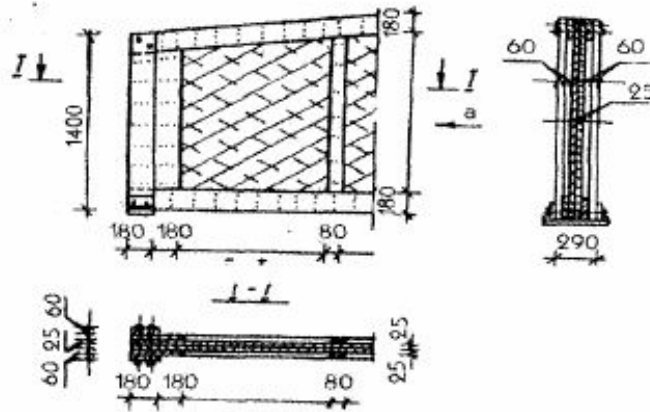

**а** – деревянная балка из досок на гвоздях;

**б**

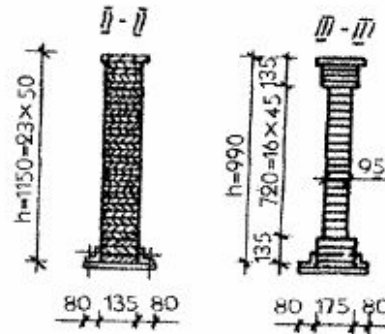
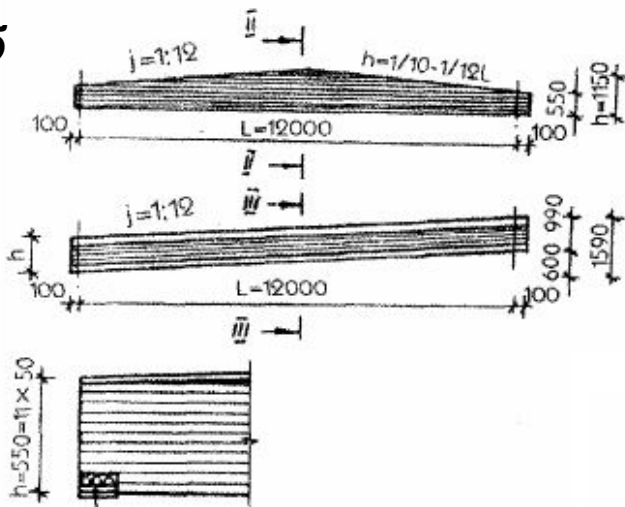

**б** – деревянные клееные балки

**в** – деревянная ферма

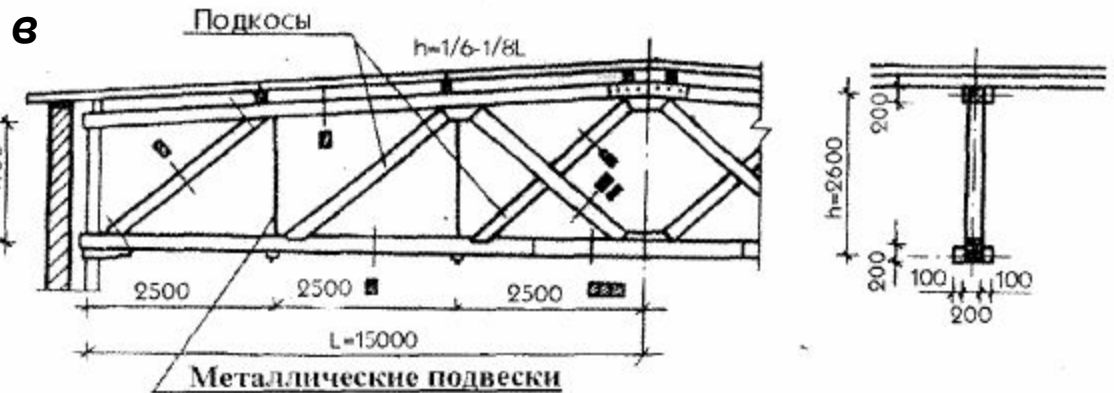









US-KONZERT™  
ДРУЖЕСТВО

VANICEK







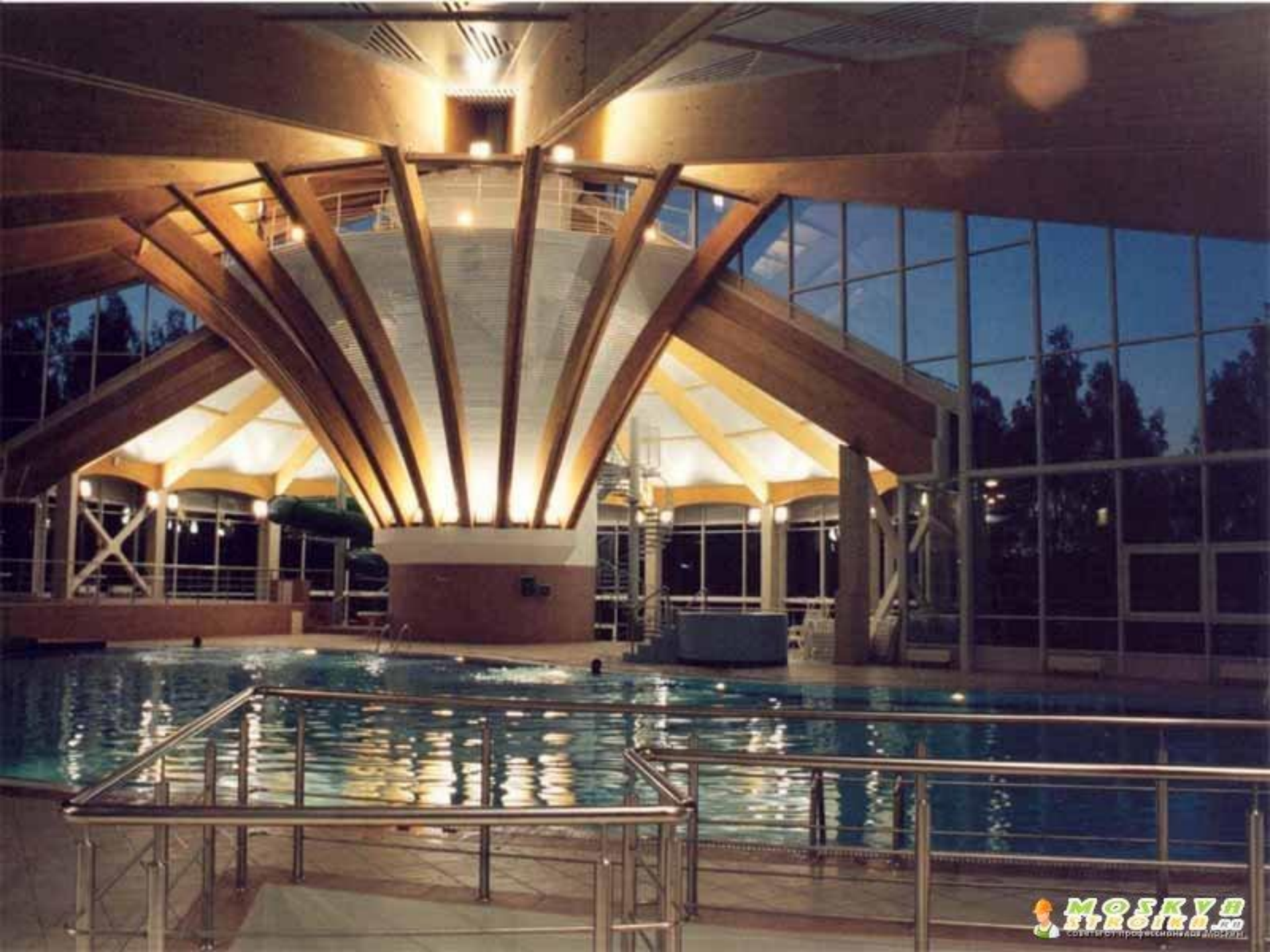









**ФЕРМЫ**

# Деревянные фермы

№ п/п	l, м	Фермы с брусчатыми элементами	№ п/п	l, м	Фермы с клееными элементами
1	12		13	12	
2	15		14	15 18	
3	18		15	21 24	
4	21 24 36		16	36	
5	9 12		17	12 18	
6	12 15		18	21 24 (36)	
7	18 21		19	21 24	
8	36		20	36	
9	9 12		21	12 15 18	
10	15 18		22	12 15 18	
11	12 15 (18)		23	12 15 18 24	
12	18 21 24				





[www.arkom.su](http://www.arkom.su)









**РАМЫ**







2s2!



2011 KONZEPT™











**АРКИ**

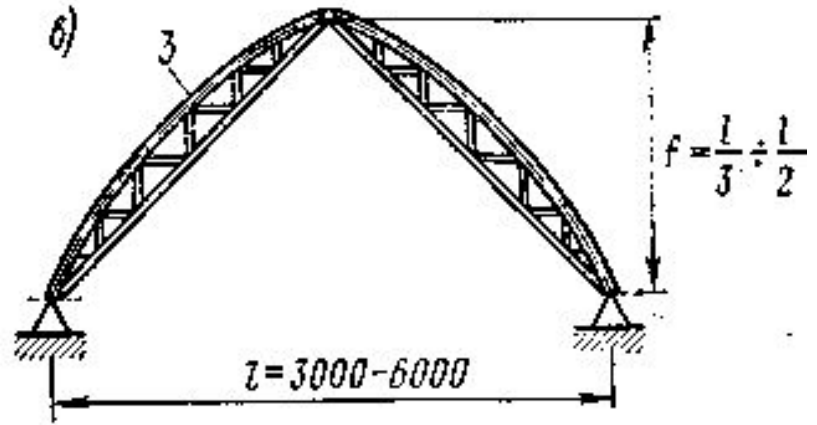
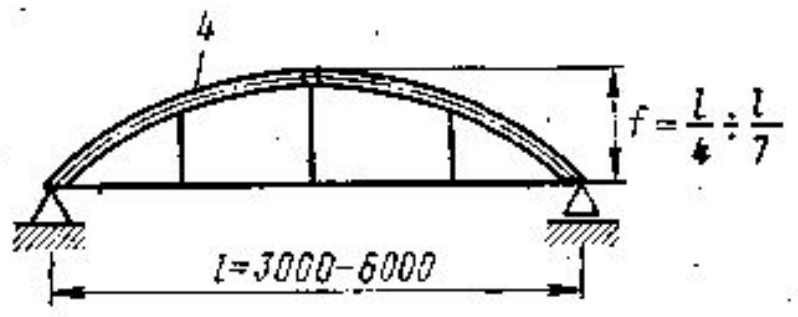
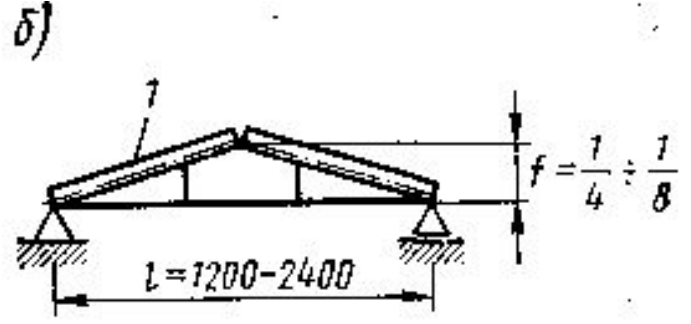
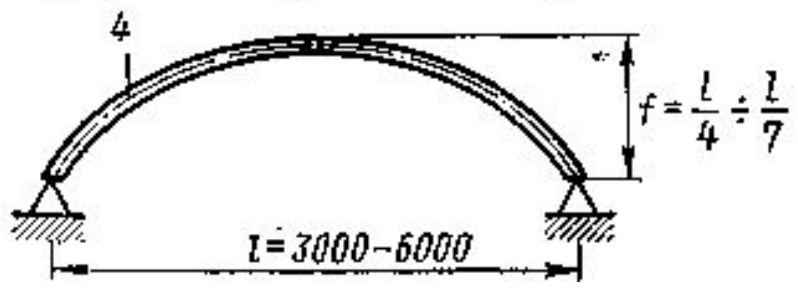
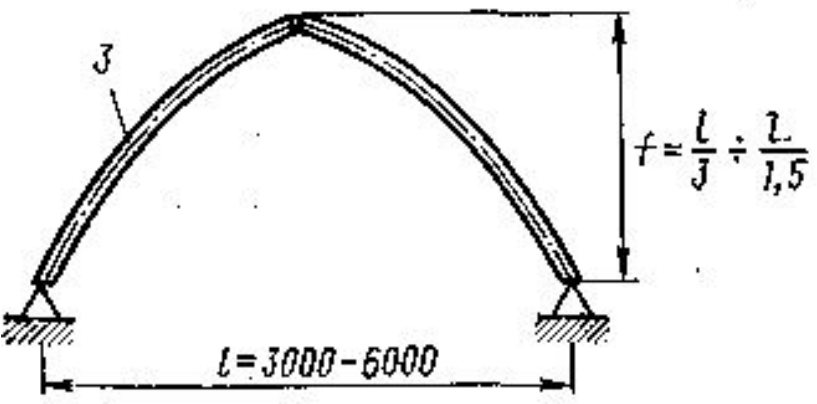
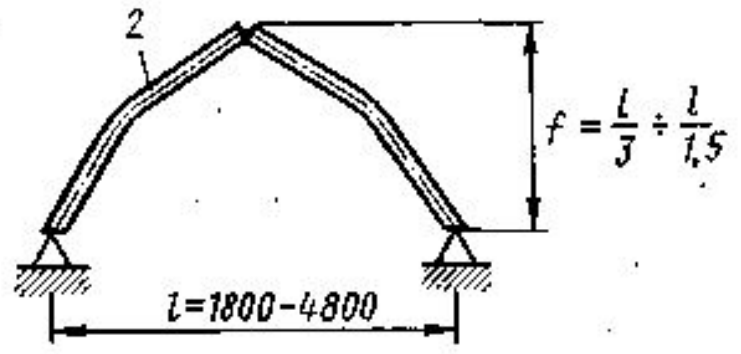
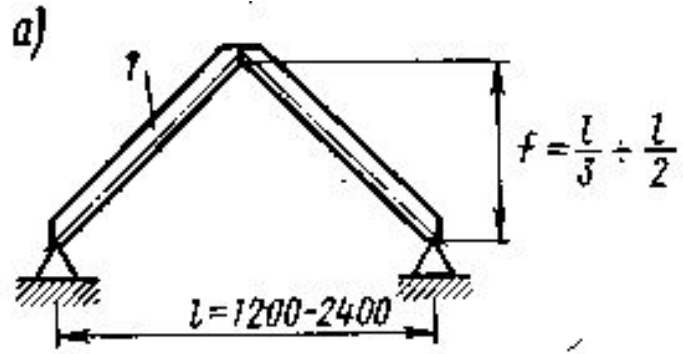

**Схемы деревянных арок:**

а — арки без затяжек; б — арки с затяжками;

в — сквозные арки; 1 — треугольная;

2 — пятиугольная; 3 — стрельчатая; 4 — сегментная















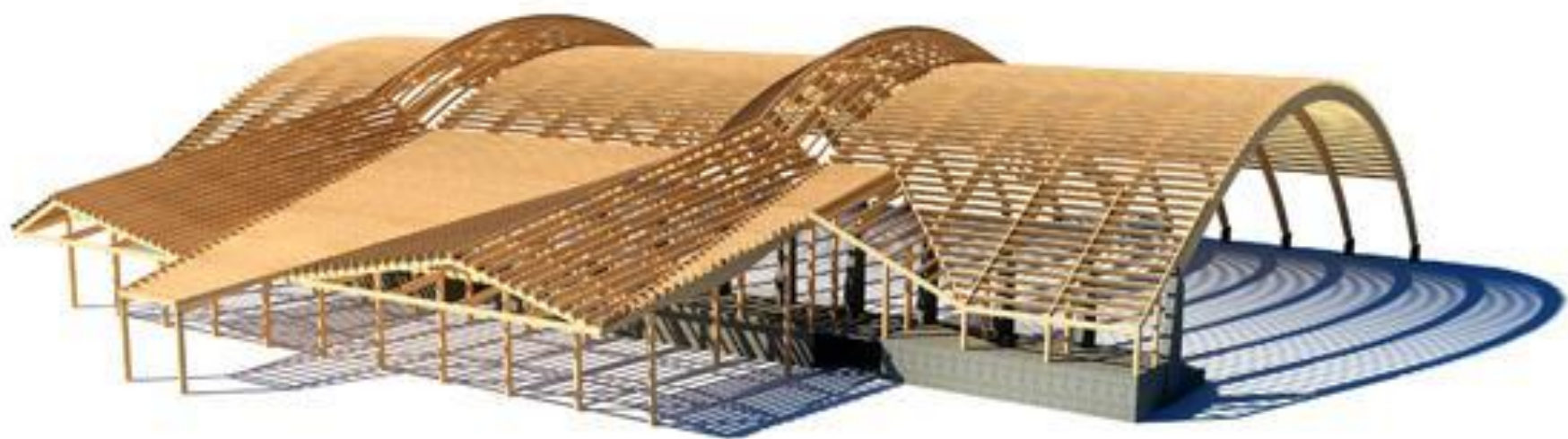



**КУПОЛА**

**Купол над зданием  
рынка  
в г. Волоколамске**

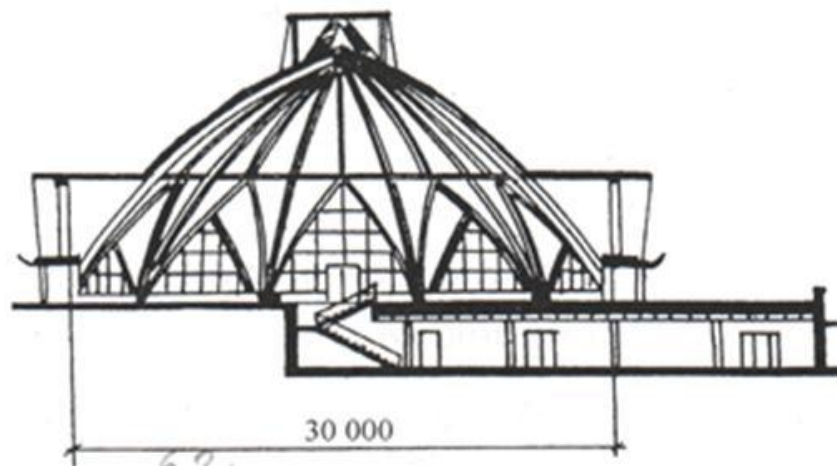

**Купол рынка в г.  
Бресте**

