

**ПОСТРОЕНИЕ  
ТРЕТЬЕГО  
ВИДА  
ПО ДВУМ  
ДАНЫМ**

# Задание № 1

Задание.

Построить третий вид по двум данным

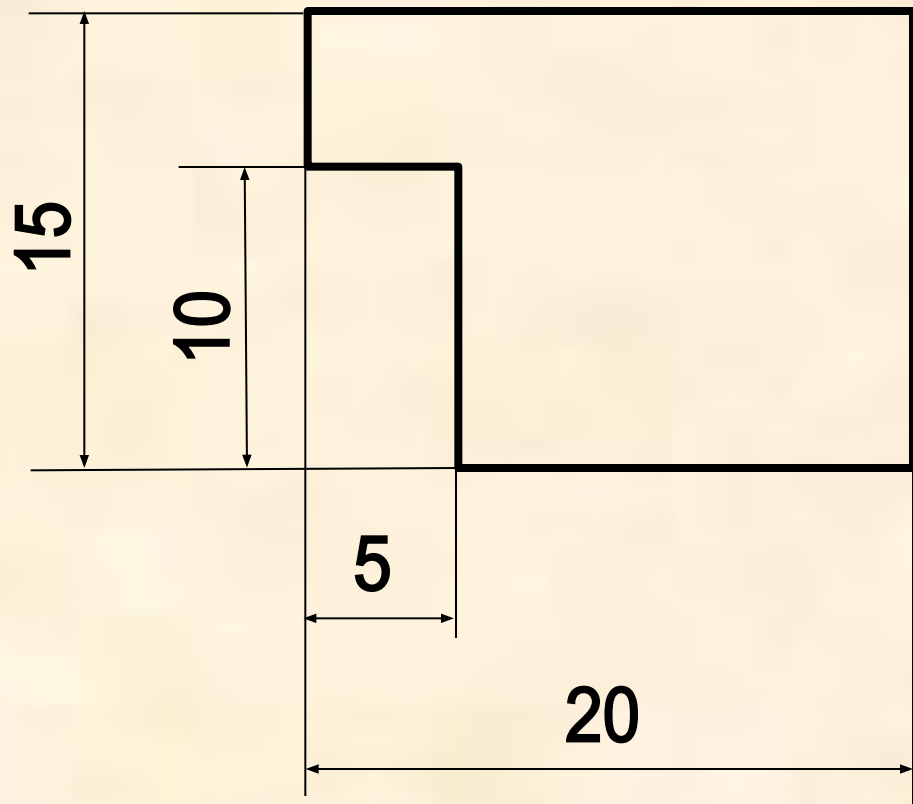

1. Построить оси



X

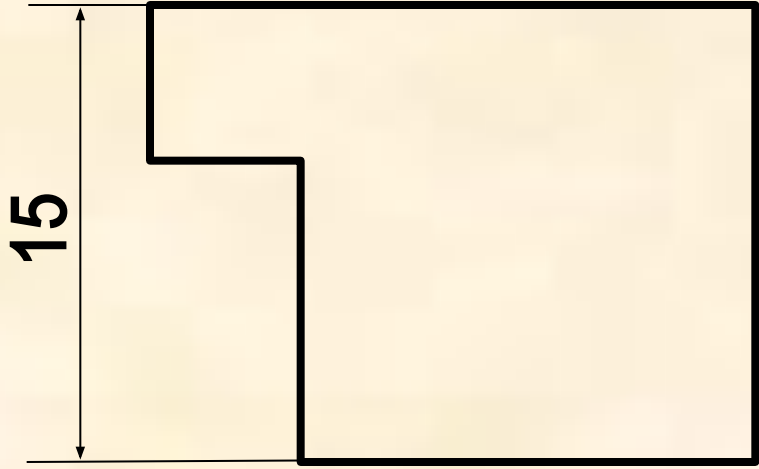

15

z

45°

y

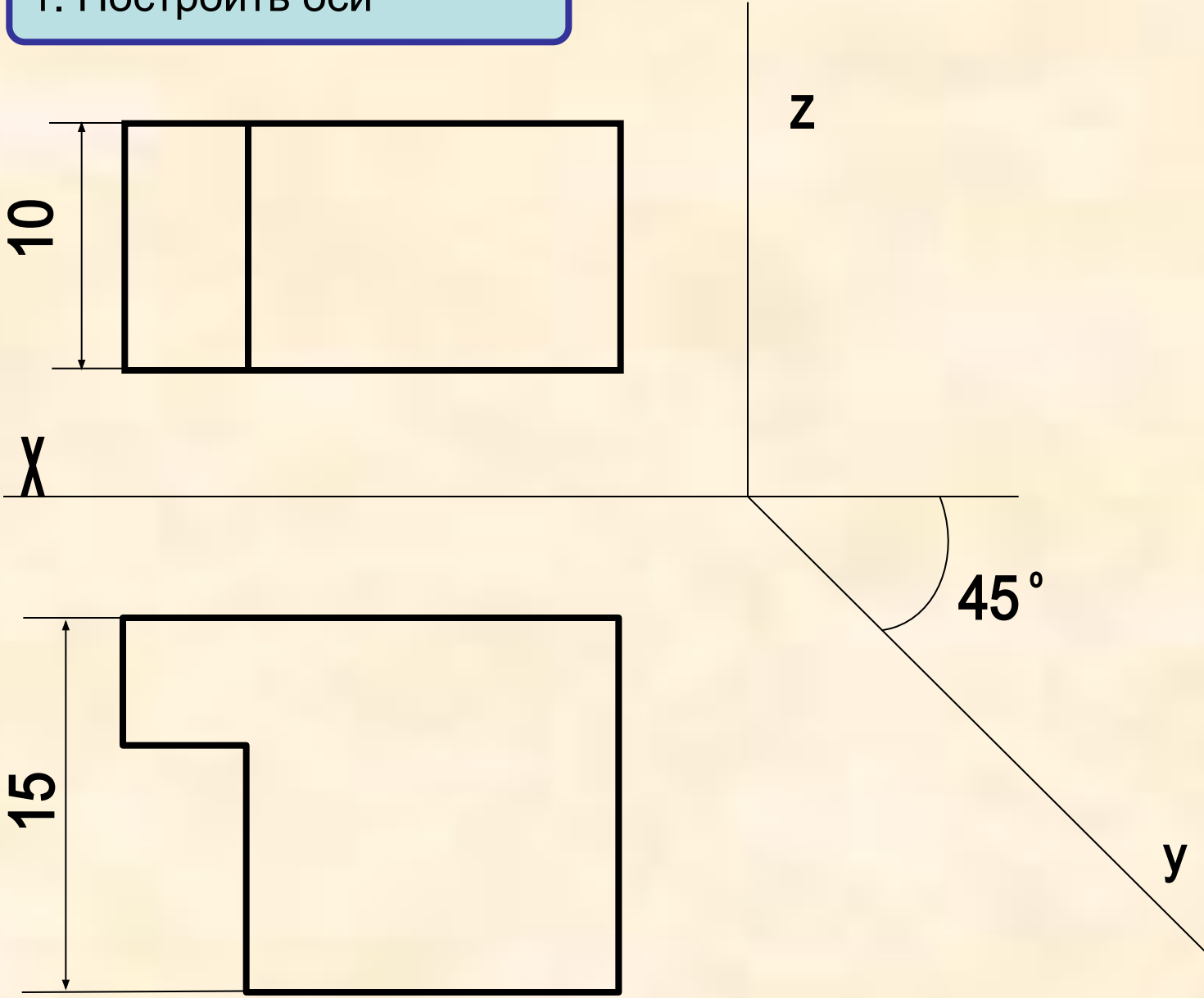

2. Построить общую форму вида слева

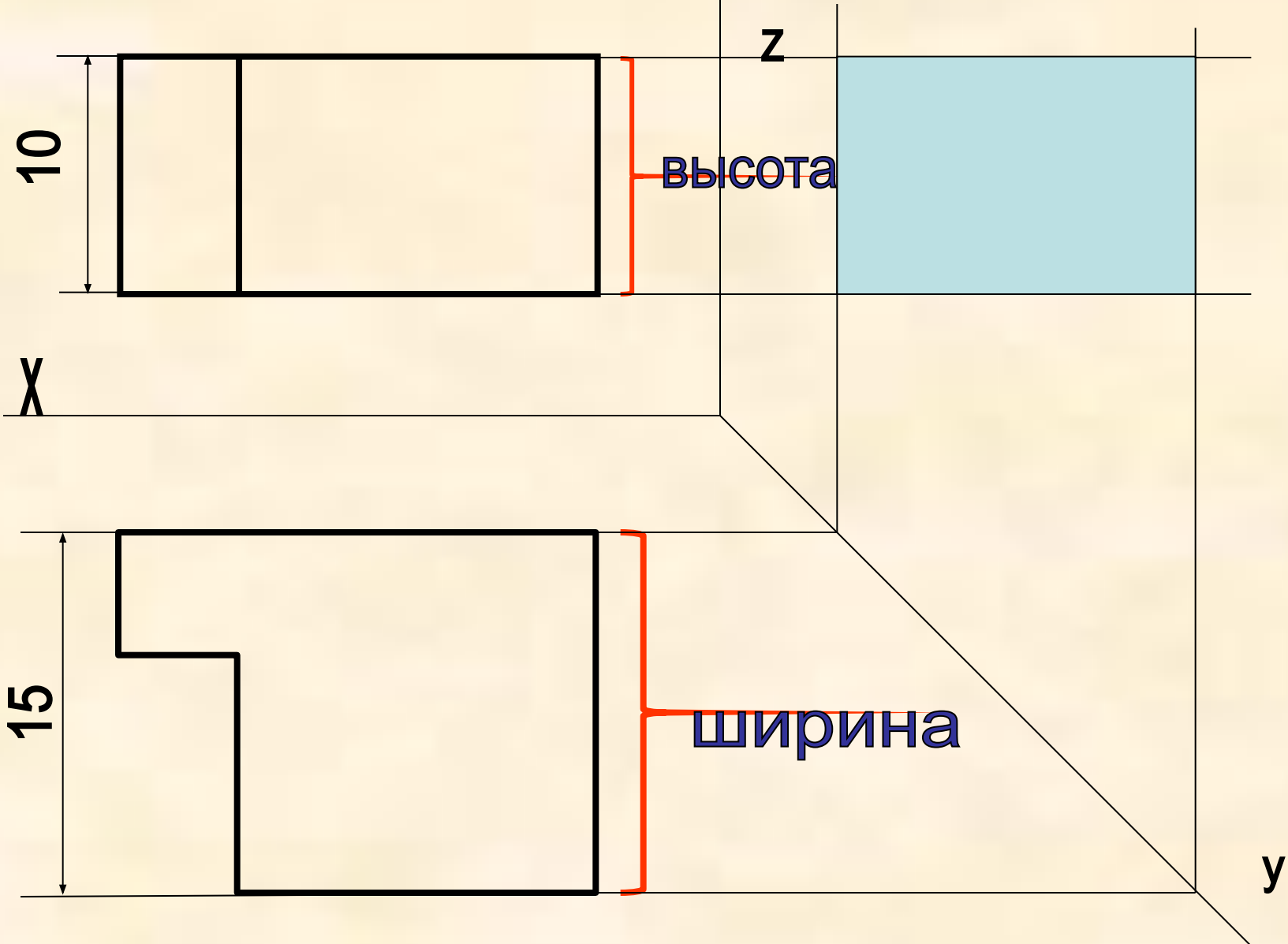

3. Построить вырез

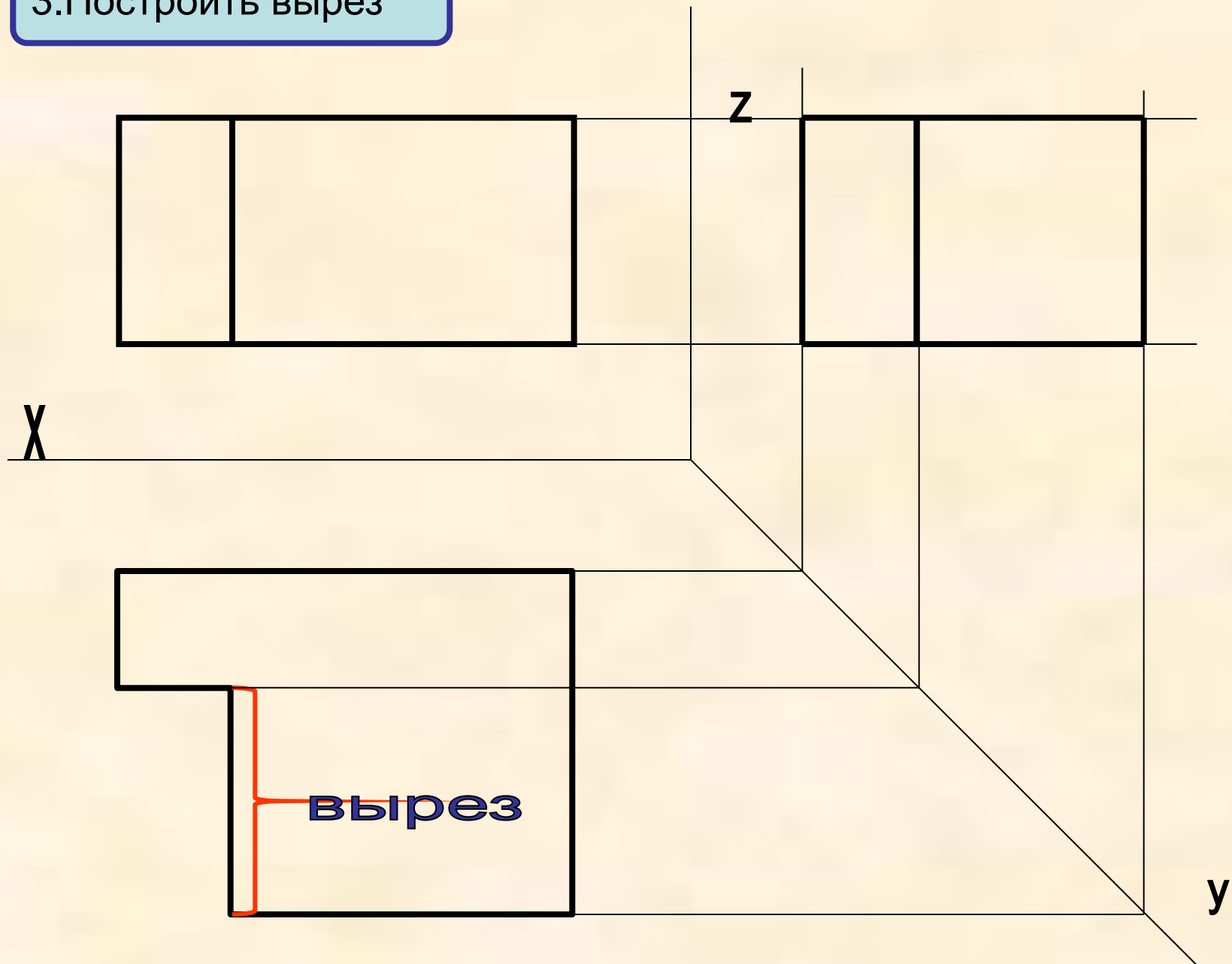

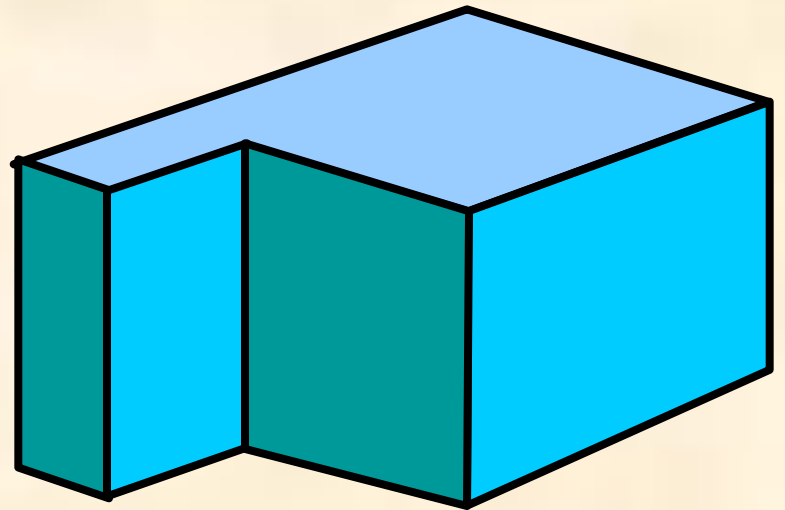

# Задание № 2



Построить третий вид

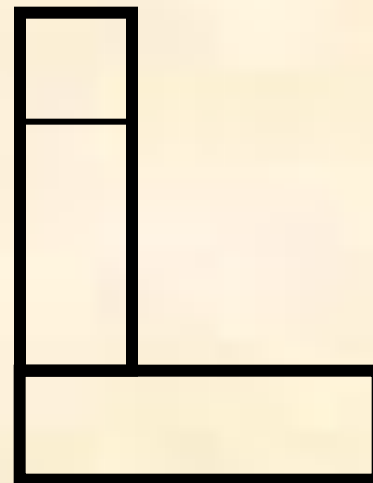
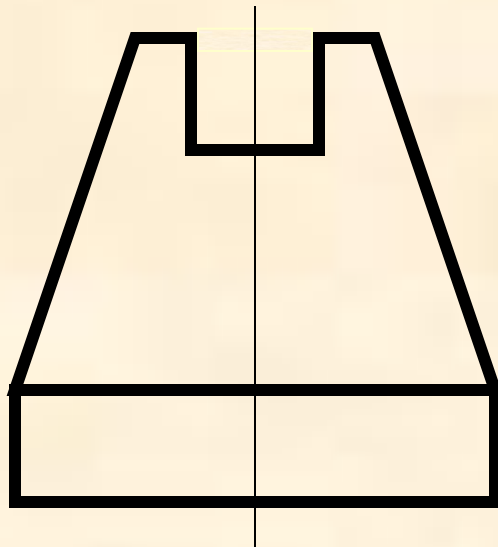

Построить третий вид

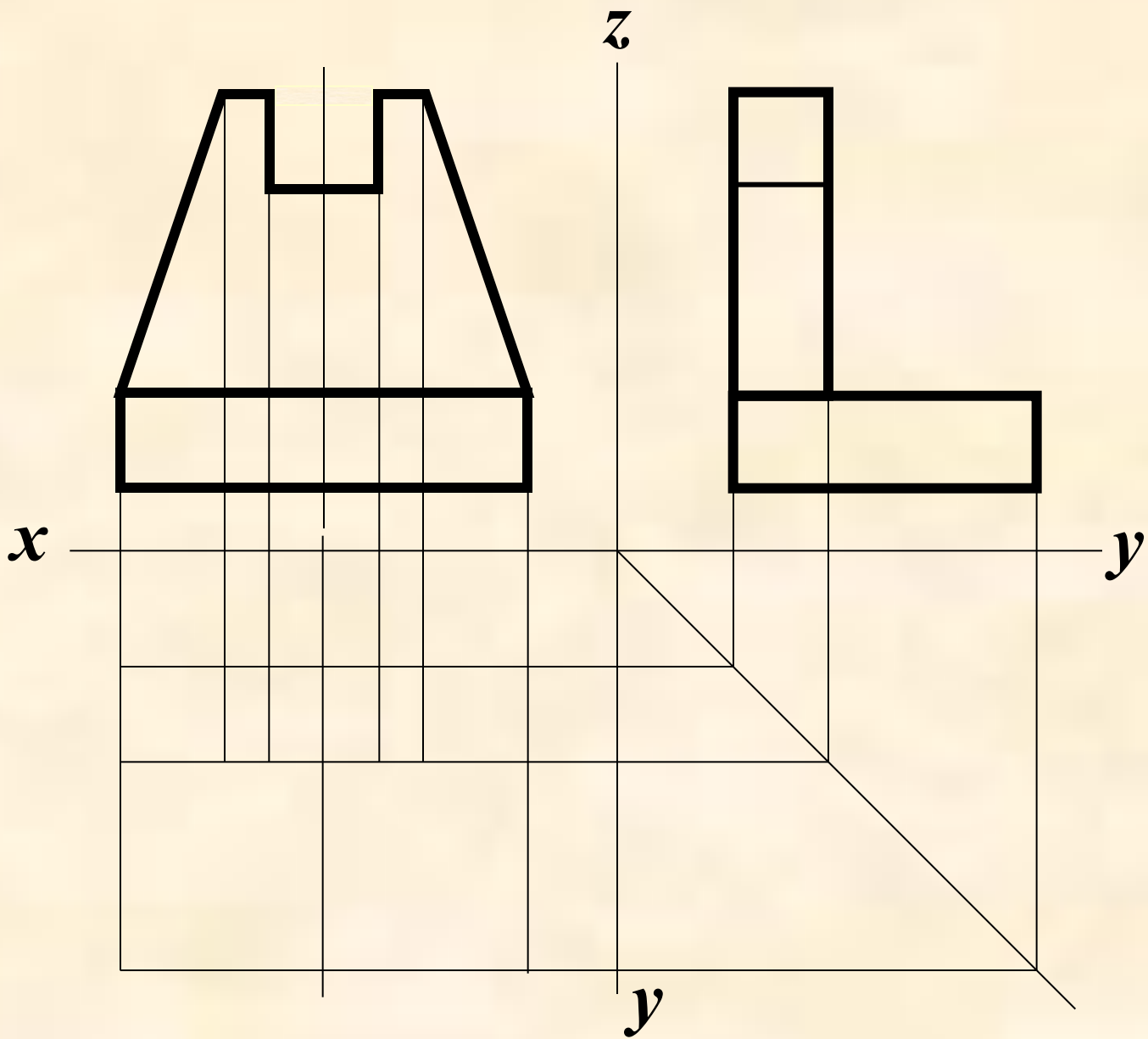

Построить третий вид

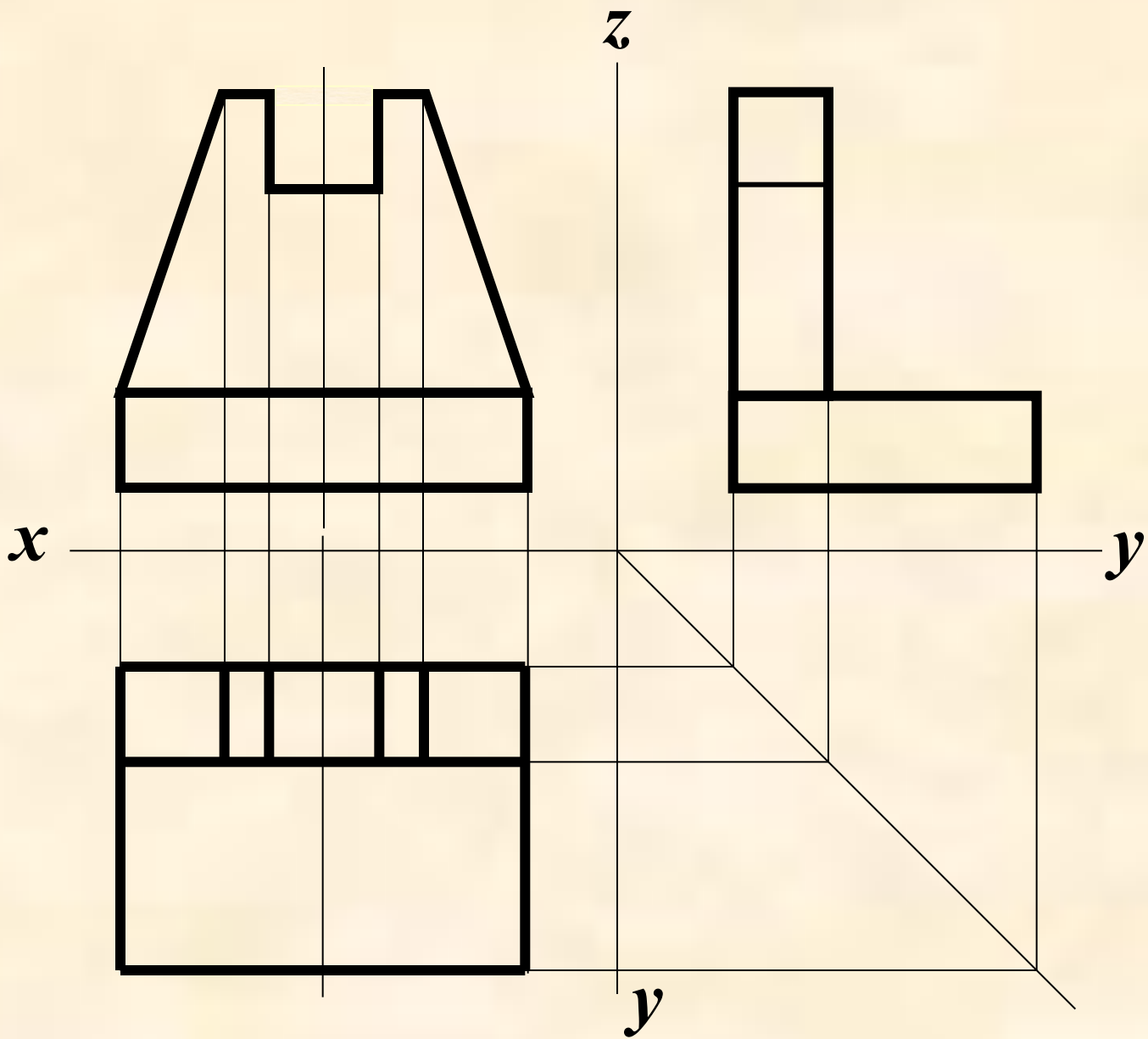

Построить третий вид

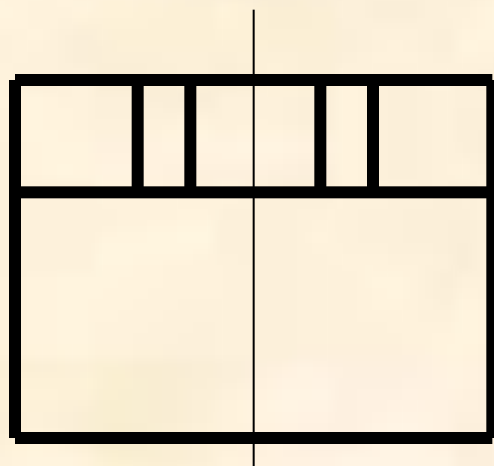
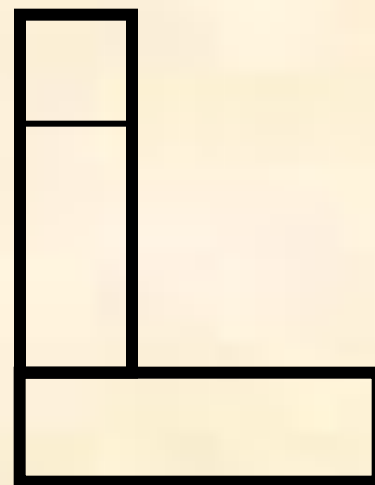
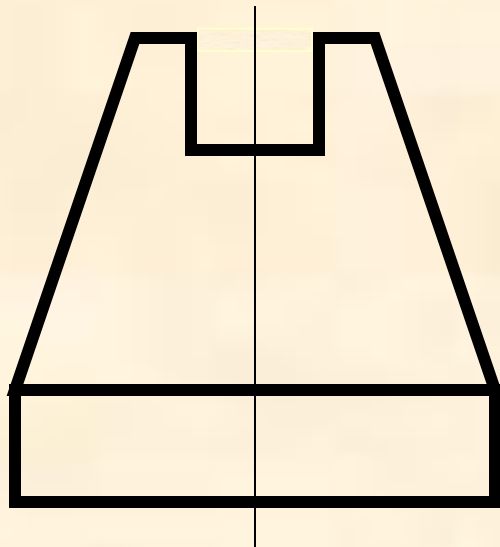

# Задание № 3

# Построить третий вид

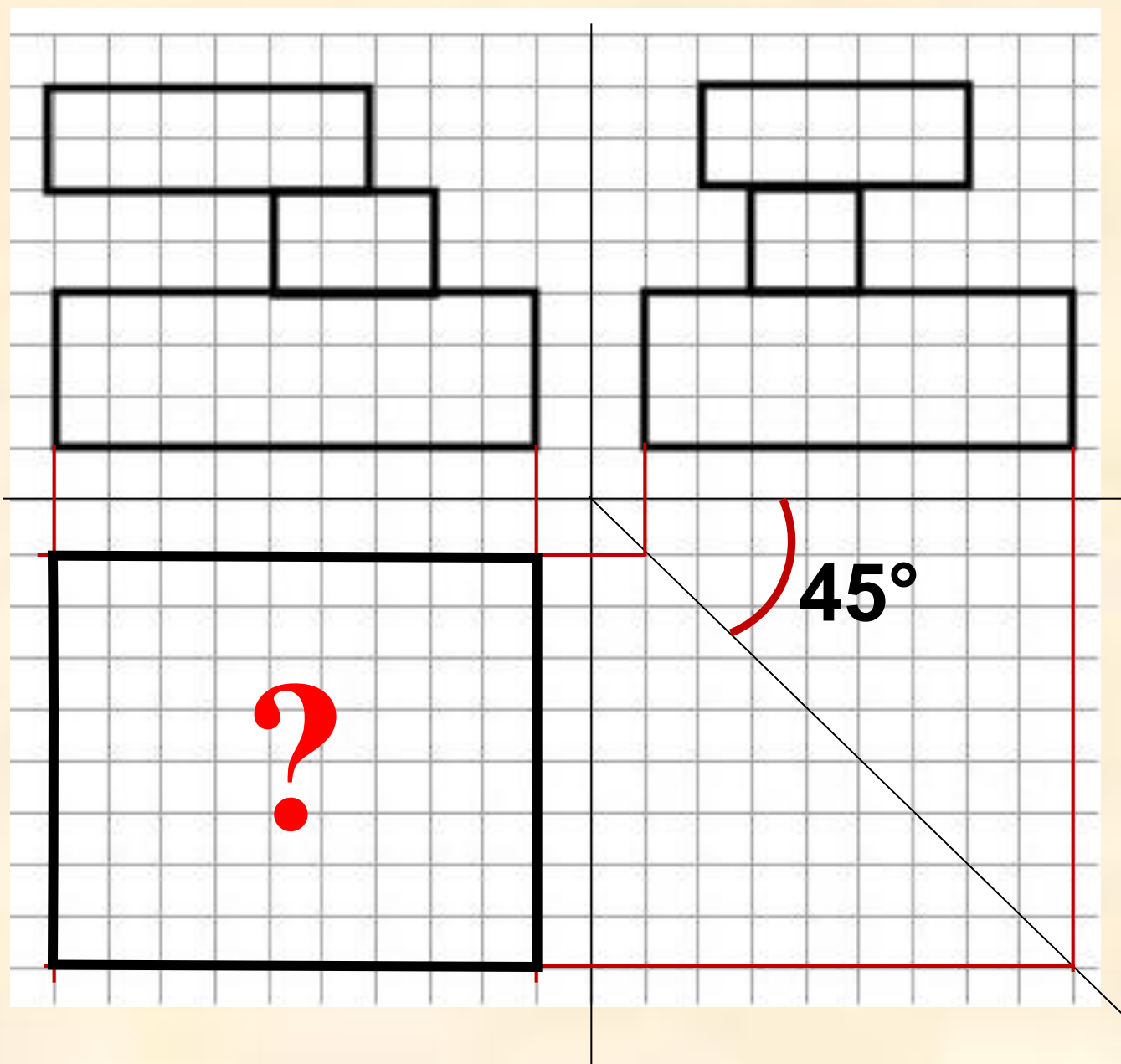

# Построить третий вид

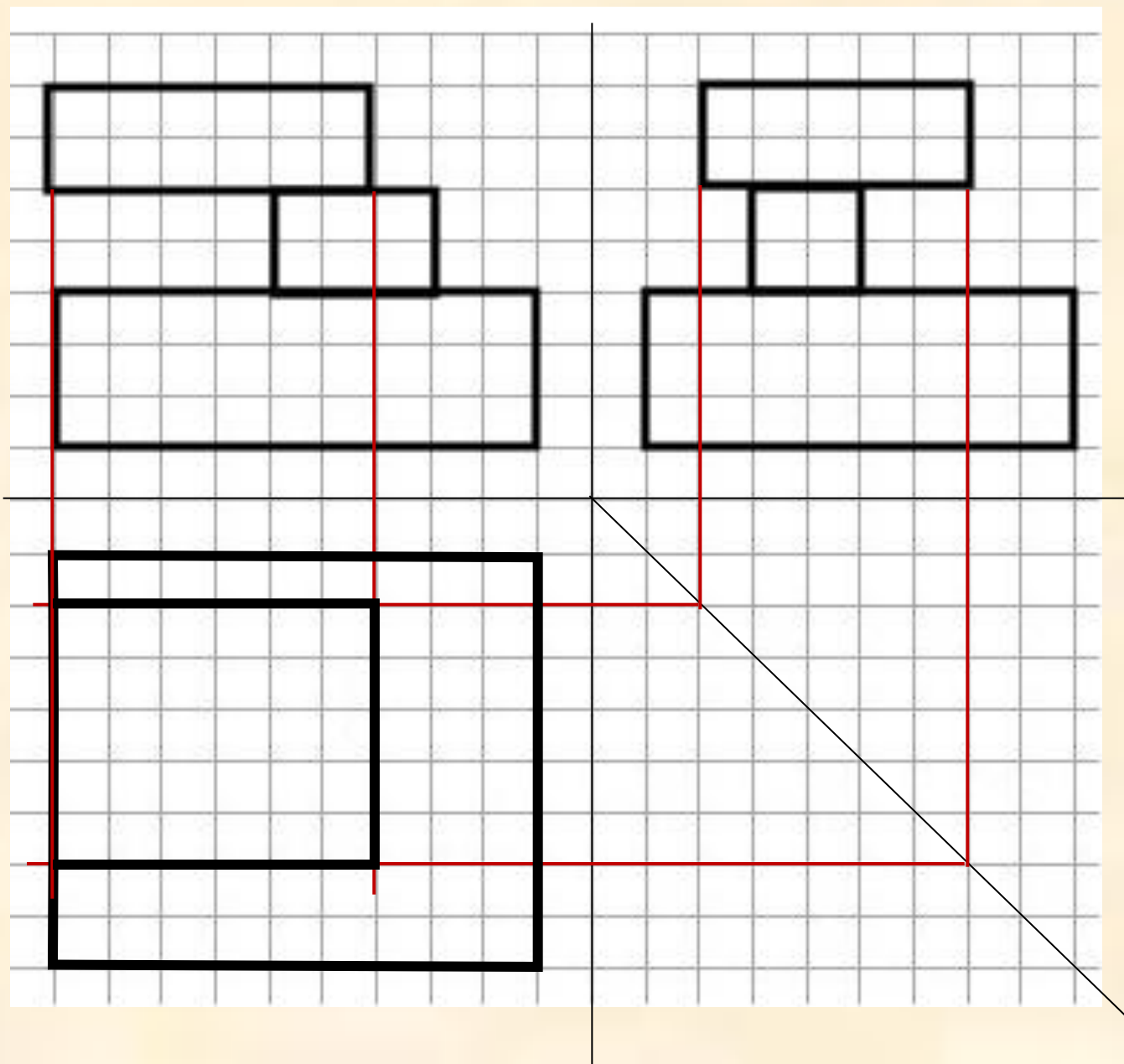

# Построить третий вид

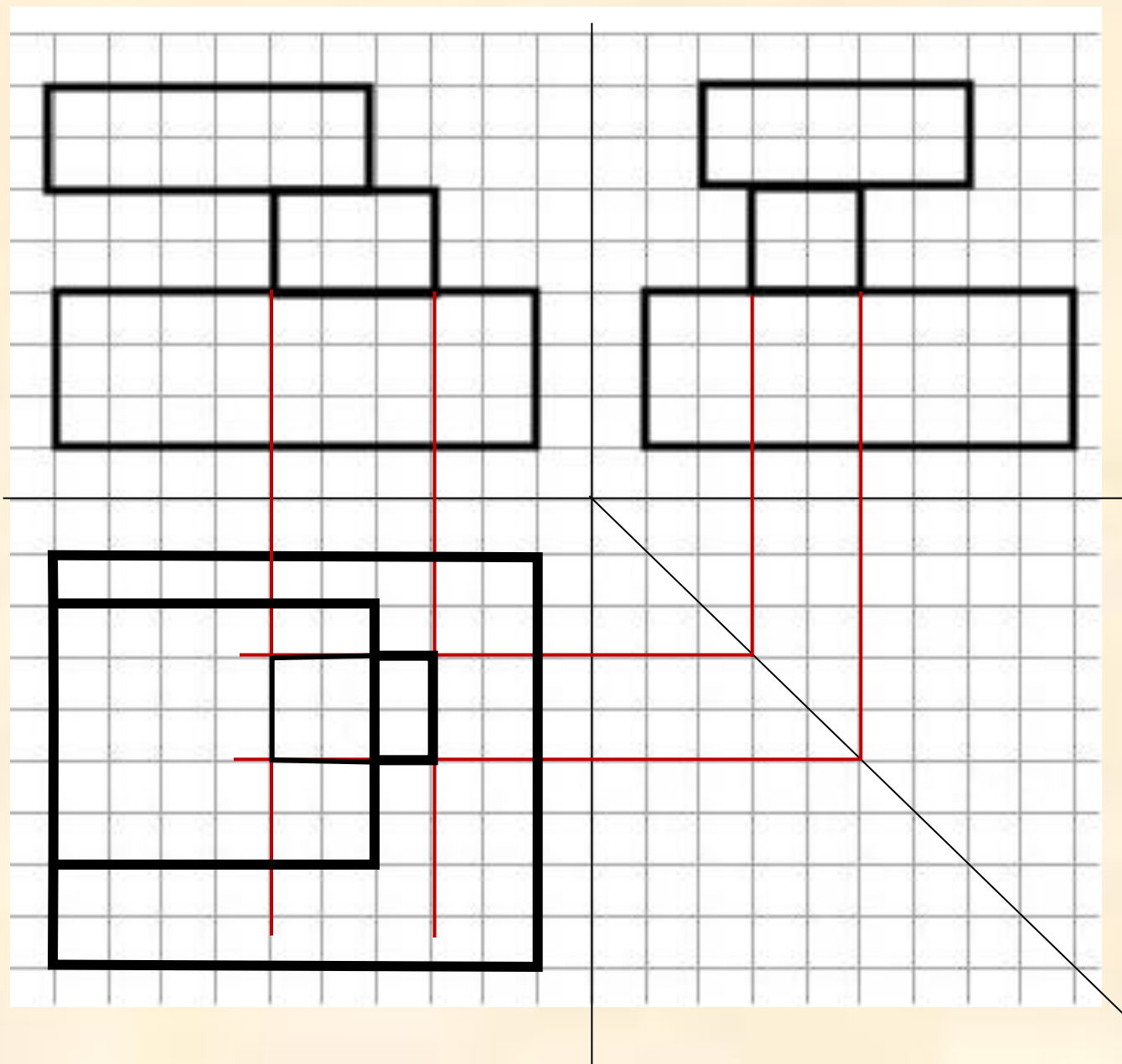



# Задание № 4

# ДЕТАЛЬ

