



Supermicro New Product Introduction

Evgeniy Borisov

2017



#18 on Fortune's Top 100 Fastest Growing Companies Worldwide

RANK	2016	2015	COMPANY
17	9		GILGAD SCIENCES (Irvine, Calif.)
18	88		SUPERMICRO (San Jose, Calif.)
19	46		BEAR STATE FINANCIAL (Little Rock)
20	48		NETFLIX (Los Gatos, Calif.)
21	29		UNIVERSAL INSURANCE HOLDINGS (Virt Ludwigsfelde)

RANK		
2016	2015	COMPANY
#18	98	SUPERMICRO San Jose



We Keep IT Green™

©2017 Supermicro®



We Keep IT Green™

©2017 Supermicro®



We Keep IT Green™

©2017 Supermicro®



Naples Product Overview

Spec	Socket G34 Abu-Dhabi CPU	Socket SP3 Naples CPU
CPU TDP	85W, 99W, 115W, 140W	120W, 150W, 180W
Socket	Socket G34 (LGA 2011)	Socket SP3 (LGA 4094)
Scalability	1S, 2S, 4S	1S, 2S
Cores	Up to 16C	Up to 32C / 64 threads
Memory	4 channels DDR3 per socket RDIMM, LRDIMM	8 channels DDR4 per socket RDIMM, LRDIMM, NVDIMM, 3DS DIMM
	1DPC = up to 1866, 2DPC = up to 1600, 3DPC = up to 1066 Up to 384GB per socket	1DPC = up to 2666, 2DPC = up to 2400, No 3DPC support Up to 2TB per socket
Cache	L2: 1 MB per core L3: 16 MB per socket	L2: 512 KB per core (16 MB total) L3: 64 MB shared cache (8 MB per 4 cores)
PCIe	PCIe 2.0 (2.5, 5.0 GT/s)	PCIe 3.0 (2.5, 5.0, 8.0 GT/s)
	42 lanes per board	1S: 128 lanes (Yes, 128 – not a typo) 2S: 128 lanes (64 lanes per socket)
SATA	6 SATAs	1S: up to 32 SATAs 2S: up to 16 SATAs
Chipset	SR56xx / SP5100	SoC (No chipset needed)
Process	32nm	14nm



NVMe

SSD

HDD



	2015	2016	2017/Future
UP	PR: Mar/'10 H8SGL(-F) Single AMD Socket G34 Opteron 6000 series 256GB ECC U/RDDR3 1600/1333/1066 in 8 DIMM AMD SR5650 chipset		New H11SSL-i(N) Single AMD Socket SP3 "Zen" x86 cores 8 channel DDR4 with ECC up to 2666MHz in 8 DIMM SoC – No Chipset
	PR: Sep/'10 H8DG6/i(-F) Dual AMD Socket G34 Opteron 6000 series 512GB ECC U/RDDR3 1600/1333/1066 in 16 DIMM Dual AMD SR5690 chipset		New H11DSi-(N)(T) Dual AMD Socket SP3 "Zen" x86 cores 8 channel DDR4 with ECC up to 2666MHz in 16 DIMM SoC – No Chipset
EATX	PR: Sep/'11 H8DGT-HL(IBQ)F Dual AMD Socket G34 Opteron 6000 series 256GB ECC U/RDDR3 1866/1600/1333/1066 in 8 DIMM AMD SR5690 chipset		New H11DST-PS Dual AMD Socket SP3 "Zen" x86 cores 8 channel DDR4 with ECC up to 2666MHz in 16 DIMM SoC – No Chipset
	PR: Nov/'10 H8DGT-H(IBQ)F Dual AMD Socket G34 Opteron 6000 series 512GB ECC U/RDDR3 1600/1333/1066 in 16 DIMM AMD SR5670 chipset		
TwinPro			

(Specifications subject to change without notice. Please contact your sales rep for possible updates.)



NVMe
SSD
HDD



WIO/
Ultra

PR: Sep/'10 **H8DGU-LN4E+**

Dual AMD Socket G34 Opteron 6000 series
768GB ECC U/RDDR3 1600/1333/1066 in 24 DIMM
AMD SR5690 chipset

PR: Mar/'10 **H8DGU(-F)**

Dual AMD Socket G34 Opteron 6000 series
512GB ECC U/RDDR3 1600/1333/1066 in 16 DIMM
AMD SR5670 chipset

New **H11DSW-i(T)**

Dual AMD Socket SP3 "Zen" x86 cores
8 channel DDR4 with ECC up to 2666MHz in 16 DIMM
SoC – No Chipset

New **H11DSU-i(N)+**

Dual AMD Socket SP3 "Zen" x86 cores
8 channel DDR4 with ECC up to 2666MHz in 32 DIMM
SoC – No Chipset

GPU

PR: May/'10 **H8DGG-QF**

Dual AMD Socket G34 Opteron 6000 series
512GB ECC U/RDDR3 1600/1333/1066 in 16 DIMM
Dual AMD SR5690 chipset

New **H11DSQ**

Dual AMD Socket SP3 "Zen" x86 cores
8 channel DDR4 with ECC up to 2666MHz in 16 DIMM
SoC – No Chipset

(Specifications subject to change without notice. Please contact your sales rep for possible updates.)



NVMe
SSD
HDD



TESLA P100 ACCELERATORS

Tesla P100
for NVLink-enabled Servers



5.3 TF DP · 10.6 TF SP · 21 TF HP
720 GB/sec Memory Bandwidth, 16 GB

Tesla P100
for PCIe-Based Servers



4.7 TF DP · 9.3 TF SP · 18.7 TF HP
Config 1: 16 GB, 720 GB/sec
Config 2: 12 GB, 540 GB/sec

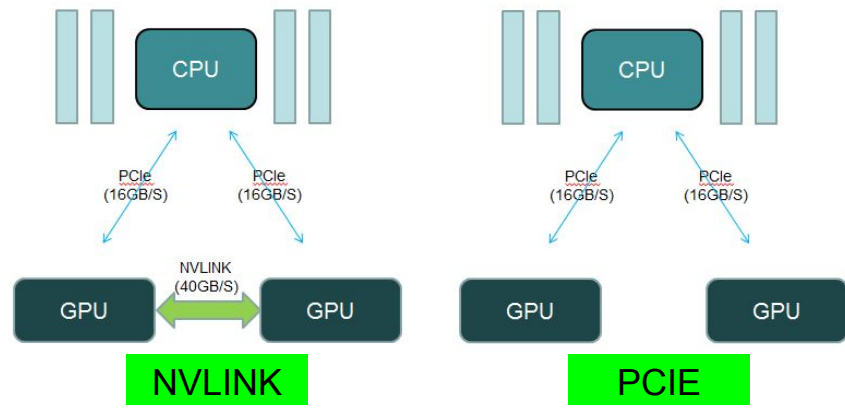
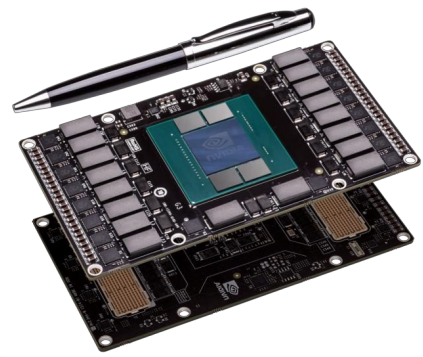

NVMe
SSD
HDD



The Latest GPU Solutions

10

4028GR-TR2

Flexibility



- 4U Chassis
- Dual HSW/BDW CPUs
- 24 DDR4 DIMMs
- 24 2.5" HS HDD bays
- **10 Double-Wide GPUs**
- 11/1 x16/x8 PCIe 3.0 slot;
- 4 (2+2) 2000W Titanium PWS

4

1028GQ-TXR

Scalability



- 1U Chassis
- Dual HSW/BDW CPUs
- 16 DDR4 DIMMs
- 2 2.5" HS HDD bays
- **4 Pascal w/ 40GB/s NVLink**
- 3/1 x16/x8 PCIe 3.0 slot
- 2 2000W Titanium PWS

8

4028GR-TXR

HyperScale



- 4U Chassis
- Dual HSW/BDW CPUs
- 24 DDR4 DIMMs
- 16 2.5" HS HDD bays
- **8 Pascal w/ 20GB/s NVLink**
- 4/2 x16/x8 PCIe 3.0 slot
- 4 (2+2) 2000W Titanium PWS

NVlink Enabled GPU Solutions (x86)

NVMe

SSD

HDD



SYS-1028GQ-TXR / TXRT

Unparalleled 1U platform for the highest parallel applications. No one else can do so much in **4** 1U!!! Up to Pascals with NVLink in **1U**, supporting Optimized GPU RDMA

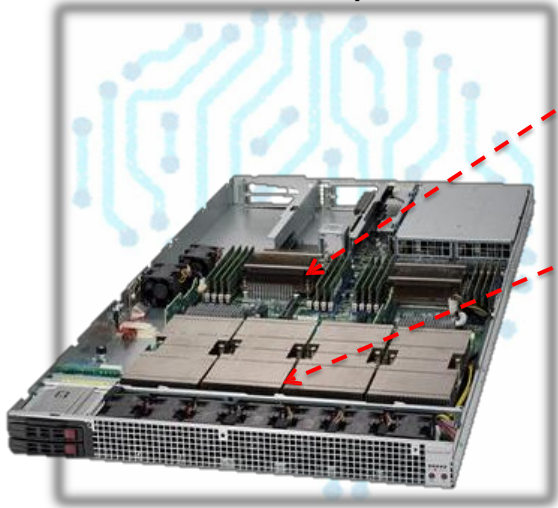

v4 BROADWELL READY
• 22 Cores / 44 Threads
• 2400Mhz Memory
• 40% performance over v3



PASCAL GPU READY
• Performance = 21 TFLOPs FP16
• NVLink – 5x PCIe
• 3D Memory - 2x Memory Bandwidth

X10 SUPERMICRO ADVANTAGE

- PERFORMANCE: 85TFLOPs Performance
- NVLINK: Exactly the best 80GB/s GPU Bandwidth
- GPU RDMA: Direct Internode GPU Interconnect
- EFFICIENCY: Titanium-rated Power Supply
- DESIGN: No GPU preheating

ADVANTAGES

- All GPUs capable of Peer-to-Peer direct access to all other GPUs' memory as well as as direct transfer operations via NVLink at high Bandwidth
- High performance for collective communications
- PCIe bandwidth fully available for host and/or NIC communication during inter-GPU inter-GPU communication



NVMe

SSD

HDD



SYS-4028GR-TXR



NVLINK ARCHITECTURE: CUBE MESH

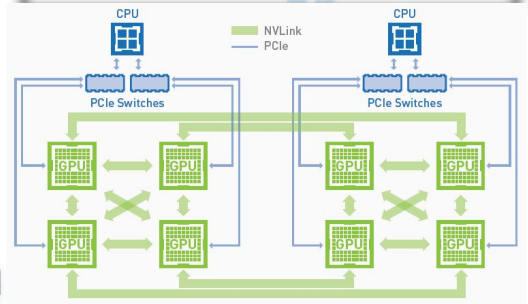

- Processor Support**
Dual Xeon E5-2600 v4/v3 CPUs
1 (Socket R3) 8 Tesla P100 (Pascal) GPUs (SXM2)

- Memory Capacity**
2 24 DIMMs, 3TB ECC DDR4 2400MHz

- Expansion Slots**
3 4 PCI-e 3.0 x16 (For RDMA via EDR)
2 PCI-e 3.0 x8

- I/O ports**
4 1x VGA, 2x 10G-BaseT LAN, 3x USB 3.0, and 1x IPMI
5 dedicated LAN port

- Drive Bays**
6 16 hot-swap 2.5" drives bay (Support up to 8x NVMe)

- System Cooling**
7 8 heavy duty fans optimize to support 8 GPU cards

- Power Supply**
4 x 2000W (2+2) Titanium Level efficiency redundant power supply

Key Features:

- PERFORMANCE: 170 TFlops with 8x Pascal GPUs
- HYPERSCALE: 80GB/s NVLINK with Cube mesh architecture
- RDMA FABRIC: Lowest latency of data access and transfer
- DESIGN: Independent GPU and CPU thermal zones



NVMe

SSD

HDD

Main Board: X10DGO

Key Features:

- Dual EP E5-2600 v4 Broadwell (Socket R3 up to 160W TDP)
- Intel C612 Chipset
- 24 DIMM, 3 TB Reg. ECC DDR4 up to 2400 MT/s, Supports NVM DIMM
- 4 PCI-E 3.0 x16 to BPN for Pascal support
- 2 PCI-E 3.0 x8 for additional expansion
- Dual port i350 or Dual Port X55010Gb LAN from PCH
- 10 SATA 3 ports (includes 2 SATADOM), 3 ports USB 3.0 (2 rear + 1 Type A)
- 15.0" x 17.0" Form Factor

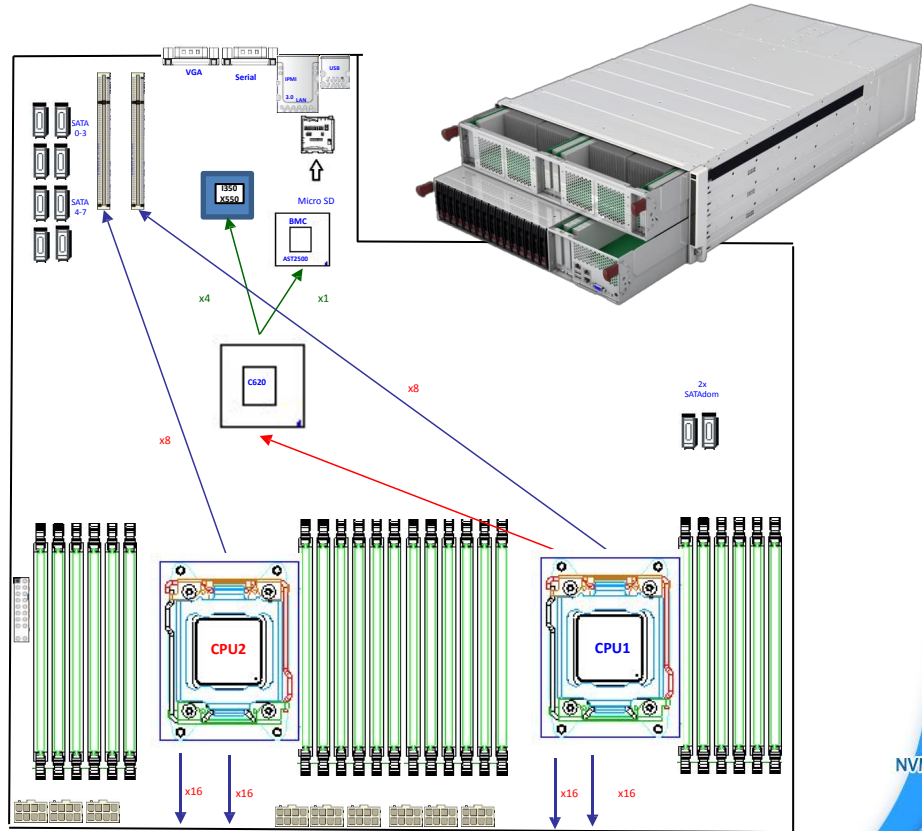
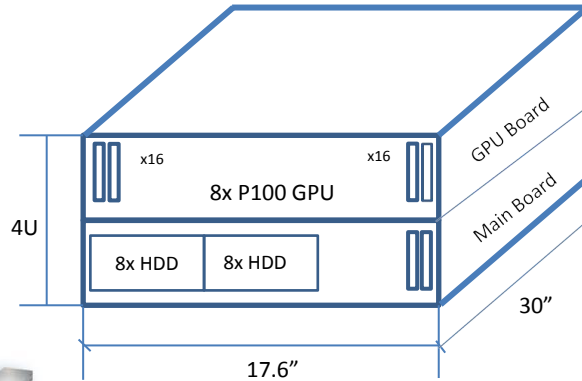

All Specifications are subject to change

NVMe

SSD

HDD



SSP-2028G-TR4T

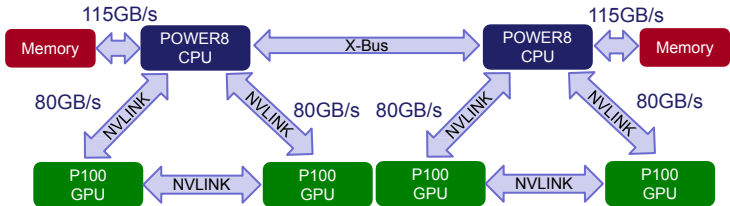
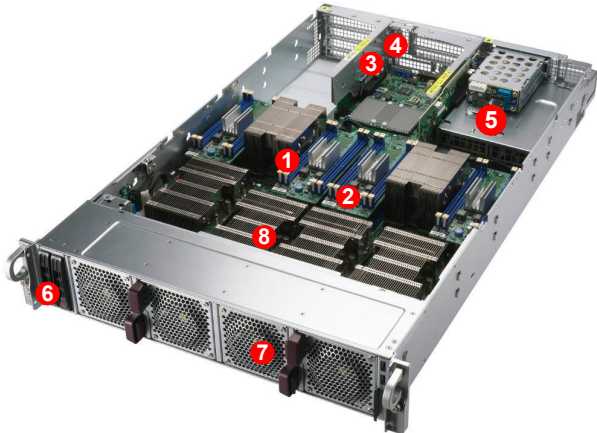

1	Processor Support IBM POWER8 processor with NVLink Interconnect
2	Memory Capacity 32 DIMMs, ECC DDR4 1600MHz
3	Expansion Slots 2 PCI-e 3.0 x16 full height 3 PCI-e 3.0 x8 full height
4	I/O ports 1x VGA, 4x 10 Gbit LAN, 2x USB 3.0, and 1x IPMI dedicated LAN port, 1 x COM port
5	Power Supply 2 x 2000W High-efficiency (Platinum level) digital redundant power supply
6	Drive Bays 4 x hot-swap 2.5" drives bay
7	System Cooling 4 heavy duty fans w/ Optimal Fan Speed Control
8	GPU 4 x Nvidia SXM2 GPU up to 19.2GT/s

Key Features:

- Dual Power8+ Processor, X-Bus up to 4.8GT/s, 190W TDP
- 32 x DDR4 ECC DIMMs, up to 1600MHz
- 4 Nvidia SXM2 GPU up to 19.2GT/s
- 1 PCI-E 3.0 (x16/x8x8), 1 PCI-E 3.0(x8), 1 PCI-E 3.0(x16)



NVMe
SSD
HDD

4U DP SYS-4029GR-TR(T)2



DDR4

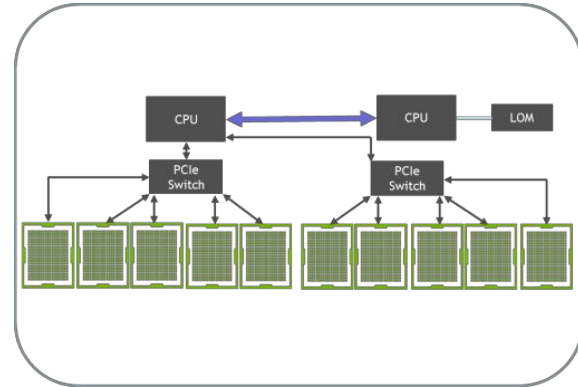
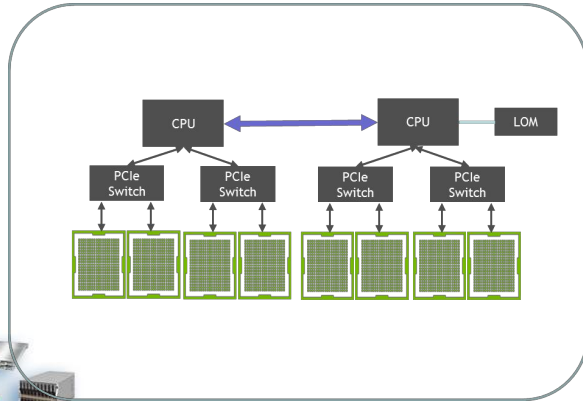

NVMe

SSD

HDD



Single-Root Design

SYS-4028GR-TR(T)

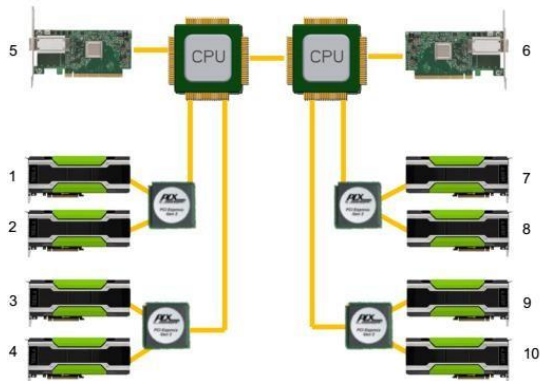

SYS-4028GR-TR(T)2

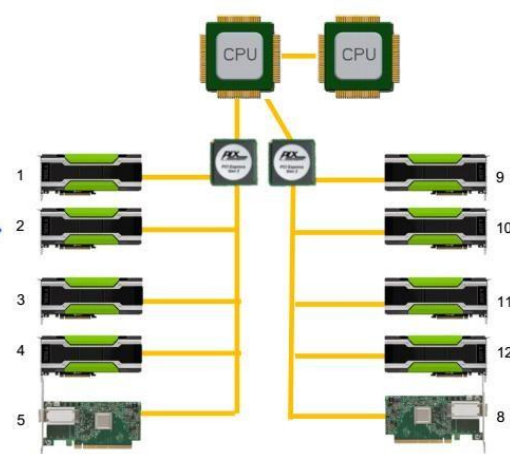

FROM	TO
GPU1	GPU2
GPU2	GPU4
GPU3	GPU9

SYS-4028GR-TR(T)	SYS-4028GR-TR(T)2
(uSEC)	(uSEC)
6.6	6.6
6.7	6.6
21.2	6.7

← **Latency winner**



NVMe

SSD

HDD

X10 GPU Server Portfolio



Ratio:
GPU:CPU

GPU OPTIMIZED

TOWER



2:4

RACK

2:8



2:4



2:6



2:4



1:2



DEEP LEARNING

2:8



2:4



2:10



NVMe

SSD

HDD



Xeon Phi 2U Twin² Server

Model Name **SYS-5028TK-HTR**



Key features

- **Density:** Uses popular Twin architecture to achieve 4 hot-pluggable nodes in 2U
- **Processor support:** Full range of KNL and KNL-F SKUs supported
- **Flexible I/O support:** Integrated dual-port Omni-Path or two low profile PCIe 3.0 x16 slots

PROCESSOR KNL / KNL-F Up to 72 cores per CPU
CHIPSET Intel C612 chipset
MEMORY 6x DIMM slots with up to 384 GB DDR4 at 2400 MHz
EXPANSION 2x PCIe 3.0 x16 LP slots (unavailable with KNL-F)
LAN 2x Intel i350 Gigabit Ethernet
DRIVE BAYS 3x 3.5" hot-swap SATA3 drive bays per node 2x SuperDOM support
POWER SUPPLY 2x Redundant 2000 W Titanium power supplies
CHASSIS CSE-827HQ Chassis



NVMe
SSD
HDD

Options for Omni-Path with KNL

Single port Omni-Path PCIe card is available today...



AOC-SHFI-i1C

+ 2nd LP PCIe 3.0 x16 card

... and there will be SKUs with integrated dual port Omni-Path!

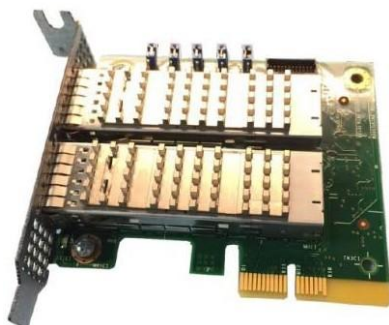

Intel Fabric Through (IFT) Carrier Card
AOC-SKL2Q



Intel Fabric Passive (IFP) Cable



KNL-F
(with fabric)





Supermicro Omni-Path Portfolio

Edge Switch - SSH-C48Q



Key features

- **Omni-Path:** 48 100 Gbps ports (QSFP28)
- **Bandwidth:** 9.6 Tbps fabric bandwidth
- **OOB:** via optional module (AOM-QA338152G)

x16 PCIe Card - AOC-SHF11C



Key features

- **Omni-Path:** Single QSFP28 Connector
- **Power Efficiency:** 11.7 W copper; 14.9 W optical
- **Optimized for HPC:** 8K and 10K MTUs

Carrier Card - AOC-SKL2Q

Key features

- **Omni-Path:** 2 100 Gbps ports (QSFP28)
- **Support:** Integrated fabric SKUs
- **Cost:** Lower than discrete components



NVMe

SSD

HDD



Xeon Phi Development System

Model Name SYS-5038K-i



PROCESSOR
KNL (fabric SKUs not supported)
CHIPSET
Intel C612 chipset
MEMORY
6x DIMM slots with up to 384 GB DDR4 at 2400 MHz
EXPANSION
2x PCIe 3.0 x16 slots 1x PCIe 3.0 x4 (in a x8 mechanical slot)
LAN
2x Intel i350 Gigabit Ethernet
DRIVE BAYS
6x 3.5" SATA3 drive bays 4x 2.5" SATA3 drive bays 2x SuperDOM support
POWER SUPPLY
1x 750 W 80 Plus Gold power supply
CHASSIS
S5 ATX Chassis with blue bezel

Key features

- **Form Factor:** ATX Mid Tower chassis
- **Quiet Operation:** Under 31 dBA at 80% load (215 W SKUs)
- **Cooling System:** Closed loop, maintenance free liquid cooling solution



NVMe
SSD
HDD



EX 7U X10 8-Way DDR4 SYS-7088B-TR4FT



SYS-7088B-TR4FT

SYS-7088B-TR4FT

- High Performance server for Mission-critical workloads
- In-memory computing and large-scale virtualization

Key features

- Eight sockets with up to 192 processor cores, 384 threads
- 192 DDR4 Memory DIMM slots, up to 24TB
- Up to 12 x 2.5" hot swap SAS3 HDD via AOC
- Up to 15 or 23(OEM) x PCI-e Gen 3 slots support
- Up to 16 x U.2 NVMe support available
- Up to 5 x 1600W 80Plus Titanium Level Power Supply

Applications

- In- Memory database application
- ERP, CRM and Business intelligence database application
- Scientific Research
- Scale-up HPC
- Virtualization

Processor	Intel® EX Xeon E7- 8800 v3/v4 series (9.6GT/s QPI) + Jordan Creek 2 (for DDR4) Intel® Patsburg-J Chipset (2 SATA3 + 4 SATA2)
Memory	192 DDR4 DIMM Slots Up to 24TB Capacity, 128GB DDR4 3DS LRDIMM Up to 1600 MHz (Performance Mode) and 1866 MHz (Lockstep Mode)
Expansion Slot	Up to 15 x PCI-E 3.0 FH slots (default) for 8 GPUs Or up to 16 U.2 NVMe + 7 PCI-E slots (optional) Or up to 23 slots (OEM)
I/O Ports (front)	1 x VGA, 1 x COM, 2 x USB 2.0 in KVM port
I/O Ports (internal)	2 x SATA DOM (SATA3), 2 x M.2 (SATA2), 2 x HDD (SATA2), 1 x TPM
Drive Bays	12 x hot swap 2.5" SAS3 HDDs (with RAID cards) 20 x 2.5" or 6 x 3.5" internal HDDs (with RAID cards)
Network (rear)	4 x 10Gb RJ45 LAN (SIOM) (SFP+ or IB for OEM) 1 x Dedicated LAN for IPMI Remote Management
Power Supply	N+1 Redundancy, default 5 x PWS-1K62A-1R(1600W) Titanium Level Power Supply (96%)
Cooling Fan	8 x 9cm hot-swappable counter-rotating rear fans
Form Factor	7U, 17.63" W, 28.87" D



NVMe
SSD
HDD



SYS-2028BT-HNR+

- 4 hot-swappable nodes in 2U
- Up to 3TB DDR4-2400 in 24 DIMM per node
- 6 NVMe per node. 2 optional M.2 NVMe/SATA
- SIOM for flexible network
- 2 PCI-e x16 expansion slots
- Redundant 2600W/2200W Power Supplies

SYS-2028BT-HTR+

- 4 hot-swappable nodes in 2U
- Up to 3TB DDR4-2400 in 24 DIMM per node
- 6 SAS/SATA per node. 2 optional M.2 NVMe/SATA
- SIOM for flexible network
- 2 PCI-e x16 expansion slots
- Redundant 2600W/2200W Power Supplies

Available NOW!



NVMe

SSD

HDD



2U BigTwin² node

High efficient
Air shroud

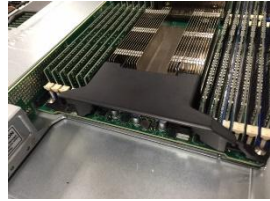

Dual E5-2600 v4 CPU
Up to TDP **205W**



24 DDR4 memory
Up to **3TB**; 2400MHz



SIOM flexible networking cards



2 low profile **PCI-e x16**
expansion slots



2 USB

VGA

IPMI dedicated LAN



NVMe

SSD

HDD



x10 Block Diagram - SAS Connectivity

(Haswell/Broadwell)

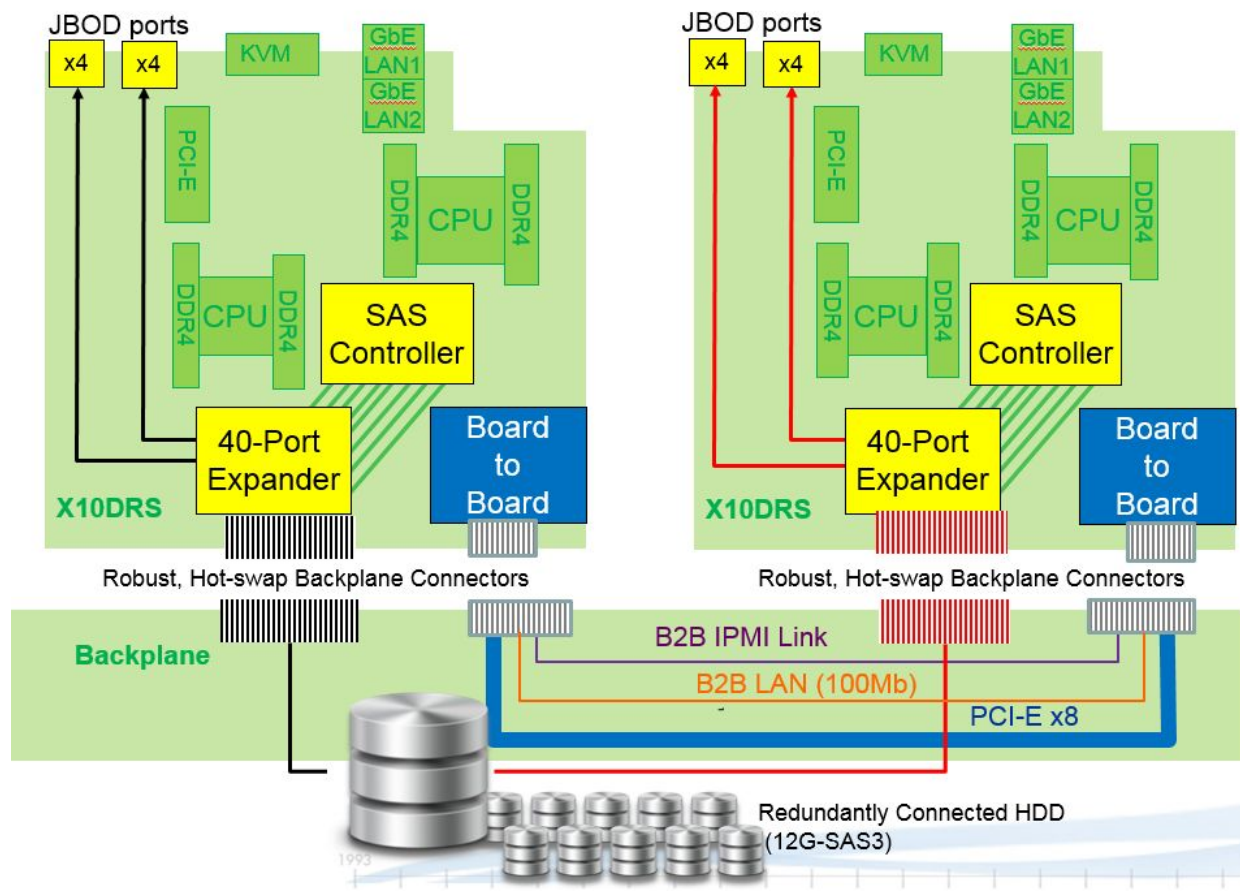

NVMe

SSD

HDD



2U SBB Dual Port NVMe

SSG-2028R-DN2R20L

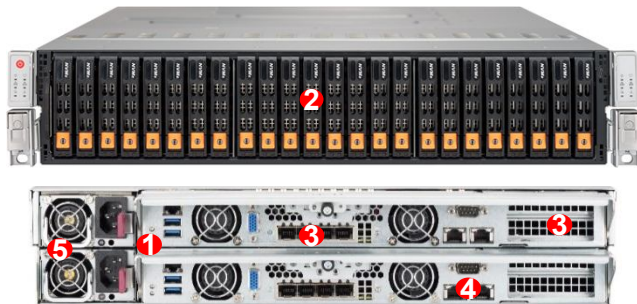

KEY FEATURES

- Redundant High Availability Design
- **20 Dual Port Hot-swap NVMe bays**
- Redundant Hot-swap Dual Processor Servers
- 16x DIMM sockets per node (DDR4 up to 2400MHz)
- Dedicated B2B connection using Intel XL710 10G private LAN
- Omni-Path SIOM Support
- 2 PCI-E 3.0 (x8 , x16) expansion slots per node

- LAN - 2x 10GBase-T
- 2x SuperDOM Ports,
- IPMI 2.0 (dedicated B2B) with Virtual Media/KVM over LAN
- Node Manager Support
- **Dimensions:** 25.6"(650mm) x 17.2"(437mm) x 3.5"(89mm)

REDUNDANT SERVER MODULES

Intel® Xeon® processor E5-2600 V3 Intel® Xeon® processor E5-2600 V4 with QPI up to 9.6GT
 CHIPSET Intel C612
 MEMORY 16 x DIMM DDR4 up to 2400MHz

1

DRIVE BAYS

20x Hot-Swap 2.5" NVMe bays
 Dual internal SATA port for OS load on SLC SATA DOM

2

EXPANSION

2x PCI-E 3.0 (x8, x16) slots per node, can be used for host connectivity or storage expansion
 1x SIOM

3

EXTERNAL I/O SUPPORT

Dual 10GBase-T RJ45 LAN per node

4

POWER SUPPLY

2000W Titanium level

5

ADDITIONAL

Dedicated Internal Board to Board connection using Intel x710 10G private LAN

Board to Board IPMI 2.0 w/ Fan Speed control; Thermal and voltage monitoring,
 1x Internal USB 3.0 Type A connector, TPM 2.0,
 2 x USB 3.0 and Dedicated LAN connector, VGA header, COM port header

Applications:

- All Flash Array Platform (OEM)
- HPC Storage (Lustre)
- Database Applications (MySQL, Cassandra)



NVMe

SSD

HDD

Super I/O Module (SIOM)

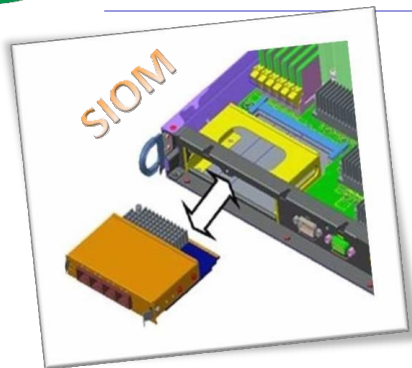

AOC-M25G-b2S

Dual port 25G (SFP28)
Broadcom controller



AOC-MHIBF-1QG

Single port FDR IB (QSFP) +
Single port 1GbE
Mellanox ConnectX-3 controller



AOC-MHIBF-2QG

Dual port FDR IB (QSFP) +
Single port 1GbE
Mellanox ConnectX-3 controller



AOC-MTP-i4T

Quad port 10G (RJ45)
Intel X550 controller



AOC-MTP-i2T

Dual port 10G (RJ45)
Intel X550 controller



AOC-MTGN-i2S

Dual port 10G (SFP+)
Intel 82599ES controller



AOC-MTG-i4S

Quad port 10G (SFP+)
Intel XL710-AM1 controller



AOC-MGP-i4

Quad port 1G (RJ45)
Intel i350-AM4 controller



AOC-MGP-i2

Dual port 1G (RJ45)
Intel i350-AM2 controller



SIOM Modular Networking

- Highly flexible, Future proof, Cold swappable,
Zero footprint design
- x16 PCI-E 3.0 interface, NC-SI, direct-to-LAN
PCH interface (*X11 and beyond*)
- *1G/10GBase-T, 10G/25G/40G/50G/100G,
Infiniband EDR, OPA, SFP+, QSFP,* and much
more to come!

- ✓ **Wide Range of Choices, Flexible Configurations, Space Saving for Regular Add-on Cards,**
- ✓ **Future Expandable, Better Cost Control and Inventory Management**





Grantley and Purley Platform Comparisons

Spec	Grantley with Broadwell-EP CPU	Purley with Skylake CPU
CPU TDP (with IVR)	55-145W, 160W WS only	45-205W
Socket	Socket R3	Socket P
Scalability	2S	2S, 4S, 8S
Cores	Up to 22C with Intel® HT Technology	Up to 28C with Intel® HT Technology
Memory	4 channels DDR4 per CPU RDIMM, LRDIMM	6 channels DDR4 per CPU RDIMM, LRDIMM
	1DPC=up to 2400, 2DPC= up to 2400, 3DPC=up to 1866	2133, 2400, 2666 2DPC No 3 DPC support
Intel® UPI	Intel® QPI: 2 v1.1 channels per CPU 9.6 GT/s max	UPI: 2-3 channels per CPU (9.6, 10.4 GT/s)
PCIe*	PCIe* 3.0 (2.5, 5.0, 8.0 GT/s)	PCIe* 3.0 (2.5, 5.0, 8.0 GT/s)
	40 lanes per CPU	48 lanes per CPU Bifurcation support: x16, x8, x4

PCH

Wellsburg: DMI2 – 4 lanes; Up to 6xUSB3, 8x USB2 ports, 10xSATA3 ports; GbE MAC (+ External PHY)

Lewisburg: DMI3 – 4 lanes; 14xUSB2 ports
Up to: 10xUSB3; 14xSATA3, 20xPCIe*3 New: Innovation Engine, Integrated Intel® Ethernet 4x10GbE ports, Intel® QuickAssist Technology



NVMe

SSD

HDD



DP MB (X9-X10-X11) Transition Chart

X9 Romley

X10 Grantley

X11 Purley

Applications/Verticals	B2/R-Socket LGA-1356/2011	R3-Socket LGA-2011	P-Socket LGA-3647
Standard Server	X9DR3/F/I-LN4F+ X9DR7/E-LN4F(-JBOD) X9DR7/E-TF+ X9DPI-E/LN4E+	X10DRI(-T) X10DRL-I(LN4)/C(T)	X11DPI(-T) X11DPL-I
WIO	X9DRW-3/IF X9DRW-3LN4F+/DTF+ X9DRW-7/I(TP)F(+) X9DRW-C(T)F31 X9DBU-3/IF	X10DRW-I(T) X10DRW-E/N(T) X10DRU-I+/X(LL)	X11DDW-L/NT X11DPU X11DPU-X(LL)Z
Ultra	X9DRT-F/IBQF/IBFF X9DRT-H Series X9DRT-P Series	X10DRT-L(IBQ/IBF) X10DRT-H/HIBQ/HIBF X10DRT-P(T)/PIBQ/PIBF X10DRT-B+	X11DPT-H(T/IBF) X11DPT-PS X11DPT-B
Twin	X9DAI-Z/E X9DAL-3/I X9DAX-7/I(T)F X9DRG-QF	X10DAI/C/X X10DAL-I X10DRG-Q	X11DAI(-N) X11DPG-QT
Workstation	X9DRG-H(T)F(+)(II) X9DRG-O(T)+-CPU	X10DGQ X10DRG-H(T) X10DRG-O(T)+-CPU	X11DGQ X11DPG-SN X11DPG-O+CPU
GPU	X9DRD-7LN4F(-JBOD) X9DRD-EF X9DRD-IF/LF	X10DDW-I(N) X10DRD-I(N)TP/LTP X10DRD-L/I(N)(T)	X11DDW-L/NT X11DPD-LTP/INTP X11DPD-L(T)/INT X11DPD-S(N)
Data Center Optimized	X9DB3/I(-TP)F X9DRH-7/I(T)F X9DRX+-F	X10DRC/I-LN4+/T4+ X10DRH-C/I(T) X10DRH-ILN4/CLN4 X10DRX	X11DPH-T(Q) X11DPX X11DPX-SE
Resource Optimized	X9DRFF(-7) X9DRFF-7/I(T)G+ X9DRFR	X10DRFF-C/I(T)G X10DRFR(-T) X10DRFR-N(T)	X11DPFF-S X11DPFR-S(N)
FatTwin	X9DBS-F	X10DSC+ X10DSC-TP4S X10DSN-TS X10DRS	X11DSC X11DSC-S X11DSN-TS
Storage			

X11 BigTwin Early Ship SKUs



BigTwin²



SYS-2029BT-HNR

- 4 hot-swappable nodes in 2U
- Up to 3TB DDR4-2666 in 24 DIMM per node
- 6 NVMe per node. 2 optional M.2 NVMe/SATA
- SIOM for flexible network
- 2 PCI-e x16 expansion slots
- Redundant 2600W/2200W Power Supplies

Sampling: 5th Week of Dec. 2016
 Volume Production: 1st Week of Feb. 2017

SYS-2029BT-HTR

- 4 hot-swappable nodes in 2U
- Up to 3TB DDR4-2666 in 24 DIMM per node
- 6 SAS/SATA per node. 2 optional M.2 NVMe/SATA
- SIOM for flexible network
- 2 PCI-e x16 expansion slots
- Redundant 2600W/2200W Power Supplies

Sampling: 5th Week of Dec. 2016
 Volume Production: 1st Week of Feb. 2017

2600W/2200W Titanium level power stick module
 45X40X480mm



NVMe
 SSD
 HDD



X11 TwinPro² Early Ship SKUs



TwinPro²



SYS-2029TP-HTR/HC1R/HC0R

- 6x 2.5" Hot-Swap Drive Bays (per node)
- Up to 2TB DDR4-2666 in 16 DIMM Slots
- 2x PCI-E 3.0 x16 Slots + 1x **SIOM**. 2 optional **M.2 NVMe**
- HTR: Intel C620 for 6x 2.5" SATA3 (6 Gbps) ports
- HC1R: Broadcom 3108 controller for 6x 2.5" SAS3(12 Gbps) ports
- HC0R: Broadcom 3008 controller for 6x 2.5" SAS3(12 Gbps) ports
- 2200W Titanium level redundant power supplies

Sampling: 5th Week of Dec. 2016
 Volume Production: 2nd Week of Feb. 2017



SYS-6029TP-HTR/HC1R/HC0R

- 3x 3.5" Hot-Swap Drive Bays (per node)
- Up to 2TB DDR4-2666 in 16 DIMM Slots
- 2x PCI-E 3.0 x16 Slots + 1x **SIOM**. 2 optional **M.2 NVMe**
- HTR: Intel C620 for 3x 3.5" SATA3 (6 Gbps) ports
- HC1R: Broadcom 3108 controller for 3x 3.5" SAS3(12 Gbps) ports
- HC0R: Broadcom 3008 controller for 3x 3.5" SAS3(12 Gbps) ports
- 2200W Titanium level redundant power supplies

Sampling: 5th Week of Dec. 2016
 Volume Production: 2nd Week of Feb. 2017



NVMe
 SSD
 HDD

X11 WIO Early Ship SKUs



WIO



SYS-1029P-WTR

- 8 2.5" Hot-Swap Drive Bays in 1U
- Optional LSI 3108 AOM
- Up to 1.5TB DDR4-2666 in 12 DIMM Slots
- 3 PCI-E 3.0 Slots
- 2 GbE LAN Ports
- Redundant 700W Platinum Power Supplies

Sampling: 3rd Week of Jan. 2017
Volume Production: 4th Week of Feb. 2017



SYS-6019P-WT

- 4 3.5" Hot-Swap Drive Bays in 1U
- Cost effective
- Up to 1.5TB DDR4-2666 in 12 DIMM Slots
- 3 PCI-E 3.0 Slots
- 2 GbE LAN Ports
- 600W Platinum Power Supplies

Sampling: 3rd Week of Jan. 2017
Volume Production: 4th Week of Feb. 2017



SYS-6019P-WTR

- 4 3.5" Hot-Swap Drive Bays in 1U
- Optional LSI 3108 AOM
- Up to 1.5TB DDR4-2666 in 12 DIMM Slots
- 3 PCI-E 3.0 Slots
- 2 GbE LAN Ports
- Redundant 700W Platinum Power Supplies

Sampling: 3rd Week of Jan. 2017
Volume Production: 4th Week of Feb. 2017

NVMe

SD

SSD

X11 Mainstream Early Ship SKUs



Mainstream



SYS-6029P-TRT

- 8 3.5" Hot-Swap SATA3 Drive Bays in 2U
- Cost effective
- Up to 2TB DDR4-2666 in 16 DIMM Slots
- 6 Low profile PCI-E 3.0, 4x16 and 2x8
- 1 M.2 NVMe (PCH)
- 2 10G based-T LAN Ports
- Redundant 800W Titanium Power Supplies

Sampling: NOW
Volume Production: 4th Week of December

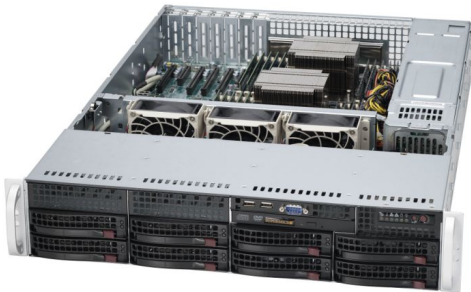

SYS-6029P-TR

- 8 3.5" Hot-Swap SATA3 Drive Bays in 2U
- Cost effective
- Up to 2TB DDR4-2666 in 16 DIMM Slots
- 6 Low profile PCI-E 3.0, 4x16 and 2x8
- 1 M.2 NVMe (PCH)
- 2 GbE LAN Ports
- Redundant 800W Titanium Power Supplies

Sampling: NOW
Volume Production: 4th Week of December



X11 Ultra Early Ship SKUs



Ultra

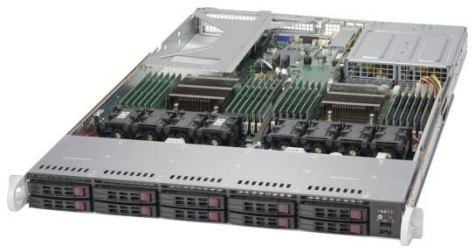

SYS-1029U-TR4+

- **10 2.5" Hot-Swap Drive Bays in 1U**
- Optional 8 SAS3 (12Gb/s) + 2 NVMe/SATA3
- Up to 3TB DDR4-2666 in 24 DIMM Slots
- 4 PCI-E 3.0 Slots
- 4 GbE LAN Ports
- Redundant 750W Platinum Power Supplies

Sampling: NOW
Volume Production: 4th Week of December

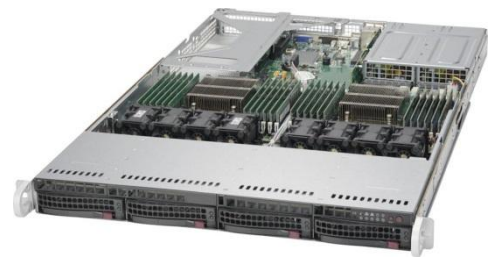

SYS-6019U-TR4+

- **4 3.5" Hot-Swap Drive Bays in 1U**
- Up to 3TB DDR4-2666 in 24 DIMM Slots
- 4 PCI-E 3.0 Slots
- 4 GbE LAN Ports
- Redundant 750W Platinum Power Supplies

Sampling: NOW
Volume Production: 4th Week of December



SYS-6029U-TR4+

- **12 3.5" Hot-Swap Drive Bays in 2U**
- Optional 8 SAS3 + 4 NVMe/SAS3
- Up to 3TB DDR4-2666 in 24 DIMM Slots
- 8 PCI-E 3.0 Slots
- 4 GbE LAN Ports
- Redundant 1000W Titanium Power Supplies

Sampling: NOW
Volume Production: 4th Week of December

NVMe
SSD
HDD

X11 SuperBlade Early Ship SKUs



SuperBlade



SBI-4129P-C2N/T3N

- 20 hot-swappable 2-socket (205W CPU) nodes in 8U
- Up to 2TB DDR4-2666 in 16 DIMM per node
- 2 NVMe/SAS3 or 3 SATA3 (2 can be NVMe) per node
- 4 M.2 NVMe per node
- 2x 10GbE+ 100G InfiniBand/Omnipath
- 8x 2200W Titanium Power Supplies (N+N or N+1 Redundancy)

Sampling: 1st Week of Jan. 2017
Volume Production: 2nd Week of Feb. 2017



SBI-8149P-T8N/C4N

- 10 hot-swappable 4-socket (205W CPU) nodes in 8U
- Up to 6TB DDR4-2666 in 48 DIMM per node
- 8 NVMe/SATA3 or 4 NVMe/SAS3 per node
- 2 M.2 NVMe per node
- 4x 10GbE or 2x 10GbE+100G InfiniBand/Omnipath
- 8x 2200W Titanium Power Supplies (N+N or N+1 Redundancy)

Sampling: 1st Week of Apr. 2017
Volume Production: 1st Week of May. 2017





UP E5 (X9-X10-X11)

2012 2013 2014 2015 2016 2017 2019

2018

High Performance Xeon Enterprise Server MB

Applications, Selling Points

HPC, Virtualization

Low-cost, I/O Intensive

WIO, 1U/3AOC

Storage with SAS/10G/SFP+

GPU, 1U/5AOC

SFF, HPC, Storage, 12V DC

Lowest-cost, mATX, VROC

MB for System Solution. Not allow to sell MB alone.

SBB Storage

X9SR/BE/F/CF/EOL
Sandy Bridge/Ivy Bridge
C602, 256GB

X9SRL /-F EOL
Sandy Bridge/Ivy Bridge
C602, 256GB

X9SRW-F EOL
Sandy Bridge/Ivy Bridge
C602, 256GB

X9SRH-7F/-7TF EOL
Sandy Bridge/Ivy Bridge
C602j, 256GB

X9SRG-F EOL
Sandy Bridge/Ivy Bridge
C602, 256GB

X10SRi-F
HSW/BDW, R3-Skt,
C612, 1TB DDR4

X10SRL-F
HSW/BDW, R3-Skt,
C612, 1TB DDR4

X10SRW-F
HSW/BDW, R3-Skt,
C612, 1TB DDR4

X10SRH-CF/-CLN4F
HSW/BDW, R3-Skt,
C612, 1TB DDR4

X10SRG-F
HSW/BDW, R3-Skt,
C612, 1TB DDR4

X10SRM-F/-TF
HSW/BDW, R3 Skt,
C612, 512GB DDR4

X11SPI-TF
Skylake/Cannonlake (C622)
1TB DDR4 LRDIMM 3DS, 10G



X11SPL-F
Skylake/Cannonlake (C621)
1TB DDR4 LRDIMM 3DS, 1G, 7x PCIe Slots



X11SPW-CTF/-TF
Skylake/Cannonlake (C622)
768GB DDR4 LRDIMM 3DS, 10G



X11SPH-nCTF/-nCTPF
Skylake/Cannonlake (C622)
1TB DDR4 LRDIMM 3DS, 10G, SAS



X11SPG-TF
Skylake/Cannonlake (C622)
1TB DDR4 LRDIMM 3DS, 10G



X11SPM-TF/-TPF/-F
Skylake/Cannonlake (C622)
768GB DDR4 LRDIMM 3DS, 10G, mATX



X11SPM-LF/LVF (TBD)
Skylake/Cannonlake (C621)
512GB DDR4 LRDIMM 3DS, 1G, mATX



X11SPS-TF (SBB)
Skylake/Cannonlake (LBG-2)
1TB DDR4 LRDIMM 3DS, 10G

Ne
W

Ne
w
Ne
w

NVMe
SSD
HDD

QSV & VHD Системы

SYS-5019S-M-G1585L

Intel® HD Graphics/Iris Pro Optimizations

X11SSH-GF-1585L, 813MFTQC-350CB

Intel® E3-1585L v5 on board 45W/3GHz, C236 Express chipset

Up to 4x ECC SODIMM slots, up to **64GB DDR4-2133MHz**

1x PCI-E 3.0 x8(in x16) add-on card slot

2x GbE I350-BT2 port, 1x dedicated

IPMI port **M.2 support**

2242/2280/22110

Intel® Iris™ Pro Graphics P580 (GT4e)

2x USB 3.0 (front/rear), USB 2.0, VGA, Serial

4x 3.5" Hot-swap SATA3 bays w/ RAID

350W High-Efficiency Power Supply

1.7" x 17.2" x 19.8"

Less than 20" depth

Optional 2.5" drive adapter

Optional slim DVD drive

SATA DOM support

Additional FAN option



SYS-5019S-MR-G1585L

Intel® HD Graphics/Iris Pro Optimizations

X11SSH-GF-1585L, 813MFTQC-R407CB

Intel® E3-1585L v5 on board 45W/3GHz, C236 Express chipset

Up to 4x ECC SODIMM slots, up to **64GB DDR4-2133MHz**

M.2 support 2242/2280/1100

Intel® Iris™ Pro Graphics P580 (GT4e)

1x PCI-E 3.0 x8(in x16) add-on card slot

2x GbE I350-BT2 port, 1x dedicated IPMI port

2x USB 3.0 (front/rear), USB 2.0, VGA, Serial

4x 3.5" Hot-swap SATA3 bays w/ RAID

Redundant 400W 1+1 power w/ BBP® option

1.7" x 17.2" x 19.8"

Less than 20" depth

Optional 2.5" drive adapter

Optional slim DVD drive

SATA

DOM support

Additional FAN

option



NVMe

SSD

HDD



Xeon + FPGA

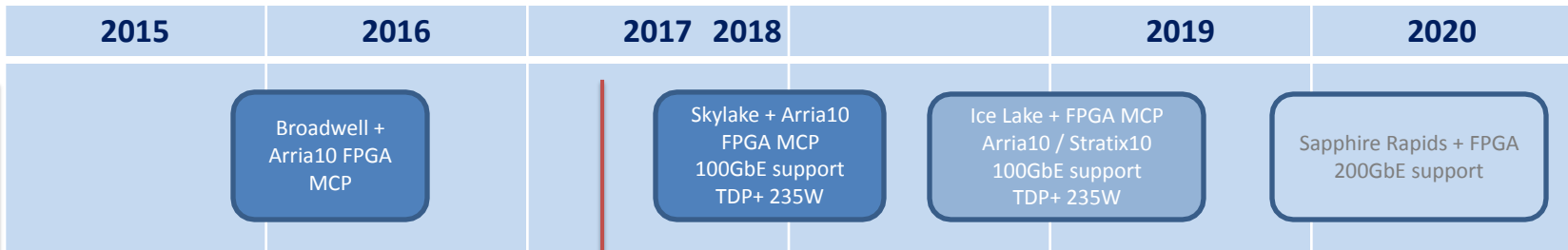

Ice Lake + FPGA Integrated on Purley

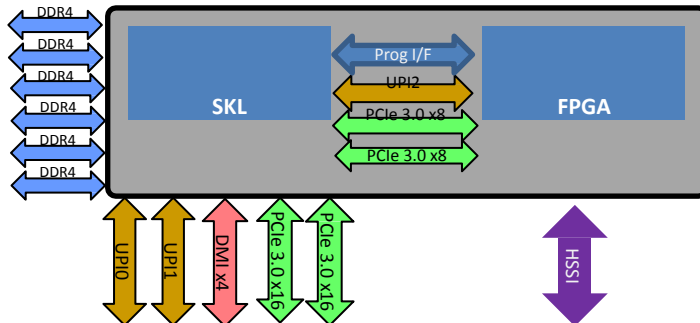

Pilot board:
X11DPZ+
(Skylake+FPGA)

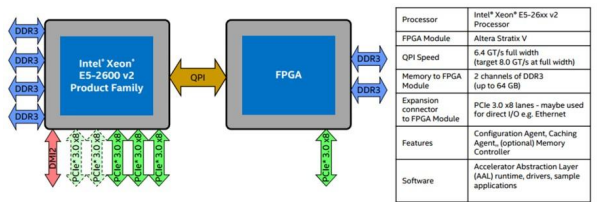

NVMe

SSD

HDD

OIST (Okinawa Institute of Science and Technology)



- Complete installation – March., 2015
- ~438 compute nodes, including SuperBlades (TwinBlade), GPU/Xeon Phi nodes and FatTwin nodes
- Performance = >275 TFLOPS
- Storage : 17 nodes (including 12 OSS nodes) = ~3PB
- Infiniband FDR connectivity for compute
- 1G/10G Ethernet connectivity for management and storage

Compute nodes: TwinBlade

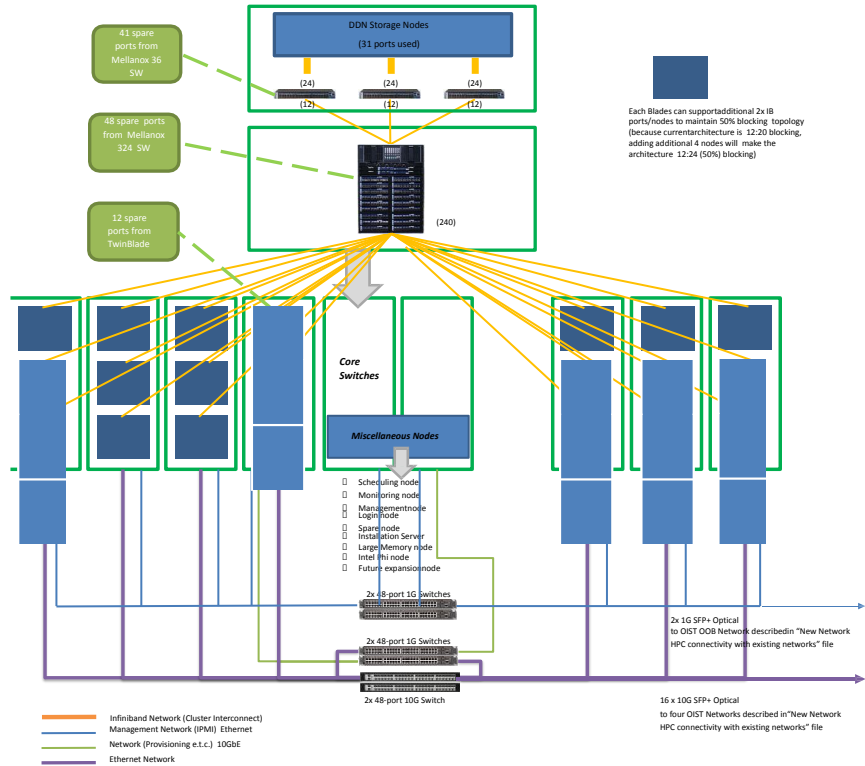

NVMe

SSD

HDD

Rutgers U. – FatTwin™ + OPA Cluster

- ❖ Supermicro RACK solution group built a 570 node FatTwin™ - 4U 8-node (Broadwell,E5-2695 v4, 560 compute nodes, 20,160 physical cores) with liquid chilled rack rear doors
- ❖ The platform uses Intel 100Gbps Omni-path, Supermicro NVMe Drives with FatTwin solution.
- ❖ The performance measured : **602.983TFLOPS** --- Top500 ranked 166 (June, 2016)
- ❖ Cooling solution: Active water rear door design



OPA Cluster – 2:1 Fat Tree Topology ToR 48 Ports Edge Switch Platform (Cost-Effective)

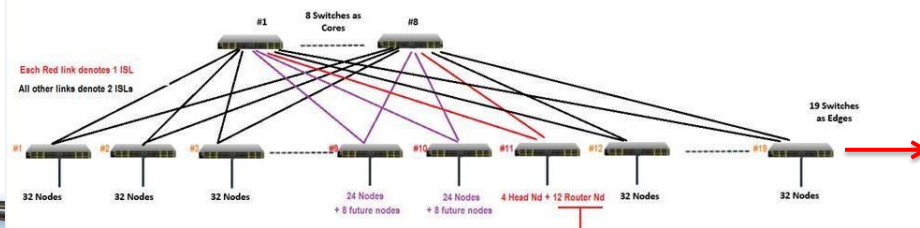

NVMe

SSD

HDD

UP Embedded 2017 Roadmap

Q1 '16 Q2 '16 Q4 '16 Q1 '17 Q2 '17 Q3 '17 Q4 '17

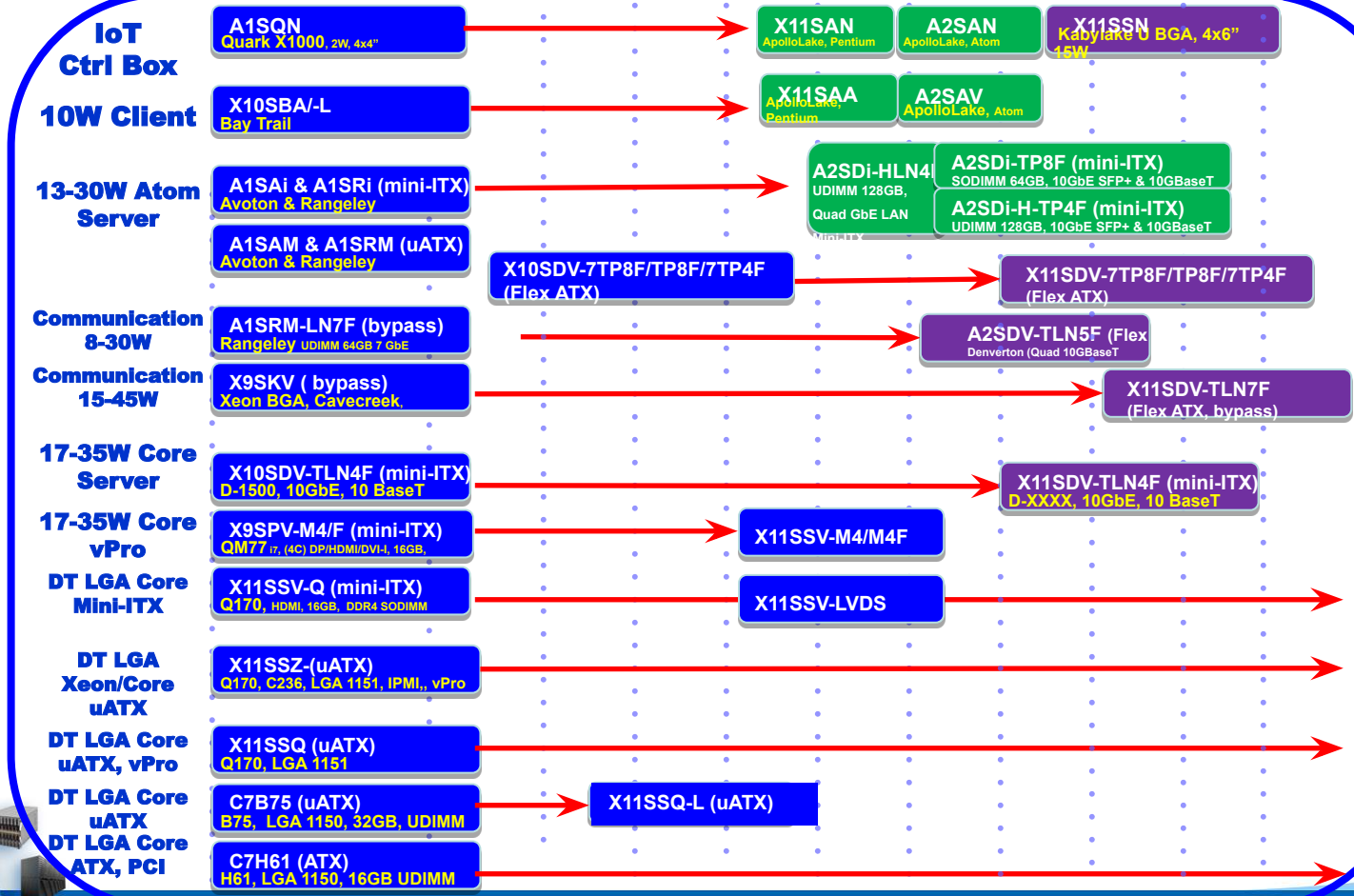

NVMe
SSD
HDD



Apollo Lake Solutions

- ✓ Building block design
- ✓ Off-the-shelf with reliable product life cycle
- ✓ VESA mount for easy deployment

Compact Box Sys.



SYS-E200-9AP
Atom SoC, QC, 9W

Mini Tower



SYS-5029AP-TN2
Atom SoC, QC, 9W

- ✓ 4 x hot-swap 3.5" HDD with 2 internal 2.5" HDD
- ✓ Low profile expansion slot for diversified application

Fanless Embedded Sys.



SYS-E100-9AP
Atom SoC, QC, 9W

- ✓ Low power consumption
- ✓ Wide operating temp -20-60C for harsh environment
- ✓ VESA/Wall mount for easy deployment



NVMe

SSD

HDD



SYS-E100-9AP



Antenna

Dual GbE LAN

Dual USB3.0

VGA

HDMI

DC-IN 12V

DIO

4x USB2.0

4x COM



NVMe

SSD

HDD



A2SAN-H/L/E

Apollo Lake 4-Core, 3.5" SBC, Wide Temp. USB 3.1, M.2 & Mini-PCle

Selling Points:

- ❖ Atom Apollo Lake-I SoC, up to 4 Core, 9.5W, HD Graphics 500
- ❖ 3.5" SBC small form factor (4"x5.75")
- ❖ USB 3.1 type C, Dual channel 48-bit LVDS
- ❖ 2 LAN Ports, 1 SATA3 Ports, Wide Operating temperature Support (-E/-L: -30 to 75C, -H: 0-60C)
- ❖ 4-Pin 12V DC
- ❖ 7 Years Product Life

Key Features:

- ❖ Up to 8 GB DDR3L 1867MHz Non ECC SODIMM
- ❖ HDMI, LVDS and VGA,
- ❖ 1x SATA3.0, 1x M.2 slot (B-key 2280 for SATA/PCle SSD or WWAN/GNSS card), 2x USB3.0, 4x USB 2.0, 4x COM ports(2 with RS-232/422/485), 1x mini PCIe, audio, 8-bit GPIO, SMBus. TPM on board

Applications:

- ❖ Industrial Automation, Transportation
- ❖ Control Board

Optimized Server:

- ❖ SYS-E100-9AP

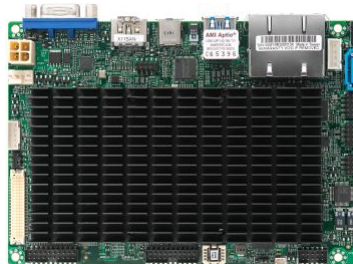

Note: -E with quad core and without Audio/USB3.1/TPM, -L with dual Core and without Audio/USB3.1/TPM



NDA Sample in Jan'17
MP in March '17

NVMe

SSD

HDD



A2SDi-2C/4C/8C+/12C-HLN4F

Denverton 2-12-Core, Quad GbE

Selling Points:

- ❖ Atom C3000 SoC, 2-12 Core, 8.5-25W
- ❖ Denverton 64-bit 14nm System on Chip, VT-d/x, TXT, AES-NI, built-in Quad GbE
- ❖ Best Performance per Watt
- ❖ Mini-ITX 6.7"x6.7" small form factor
- ❖ IPMI 2.0 with KVM and dedicated port
- ❖ 4 GbE LAN Ports with RJ45
- ❖ 4-Pin 12V DC and ATX power source
- ❖ 7 Years Product Life

Key Features:

- ❖ 128 GB up to 2133MHz DDR4 RDIMM or 64GB UDIMM
- ❖ 12x SATA3.0, 1x M.2 slot (M key for SSD, 2242/80, PCIe3.0 x2 or SATA3), 1x USB3.0 type A, 4x USB 2.0, 1x PCIe 3.0 x4, Quad GbE LAN ports

Applications:

- ❖ Network Security Appliance
- ❖ Storage Server/Appliance

SuperServer:

- ❖ SYS-5019A-2TN4(2C, SC721)

Optimized Chassis:

- ❖ SC504/505 : 1U 9.8"
- ❖ SCE300, 1U 10.0"x8.9"x1.7"
- ❖ SC101F, 1U 7.68" x8.9"x1.7"



NVMe
SSD
HDD

Note: Some SKU may de-pop M.2 or SATA ports for limited SoC I/O support



Sample in Jan'17
MP in Feb'17





A2SDi-H-TP4F

Denverton 16-Core, Quad 10GbE (SFP+ & 10GBaseT), 12x SATA3

Selling Points:

- ❖ Atom C3000 SoC, up to 16 Core, 35W
- ❖ Denverton 64-bit 14nm System on Chip, VT-d/x, TXT, AES-NI, built-in 10GbE
- ❖ Best Performance per Watt
- ❖ Mini-ITX 6.7"x6.7" small form factor
- ❖ IPMI 2.0 with KVM and dedicated port
- ❖ 4 LAN Ports with Dual 10GbE SFP+ and Dual 10GBaseT
- ❖ 4-Pin 12V DC and ATX power source
- ❖ 7 Years Product Life

Key Features:

- ❖ 128 GB up to 2133MHz DDR4 RDIMM or 64GB UDIMM
- ❖ 12x SATA3.0, 1x M.2 slot (M key for SSD, 2242/80, PCIe3.0 x2 or SATA3), 1x USB3.0, 4x USB 2.0, 1x PCIe 3.0 x4, Quad 10GbE LAN ports with 2x SFP+ and 2x 10GBase-T (SoC)

Applications:

- ❖ Network Security Appliance
- ❖ Storage Server/Appliance

Optimized Chassis:

- ❖ SC801 : 1U 12x 3.5 HDD
- ❖ SC504/505 : 1U 9.8"
- ❖ SCE300, 1U 10.0"x8.9"x1.7"
- ❖ SC101F, 1U 7.68" x8.9"x1.7"
- ❖ SC721, 11"x8.2"x9.45"



Sample in January '16
 MP in March '17
 A2SDi-H-TF with Dual 10GBaseT only



NVMe

SSD

HDD

Как насчет большего хранения?

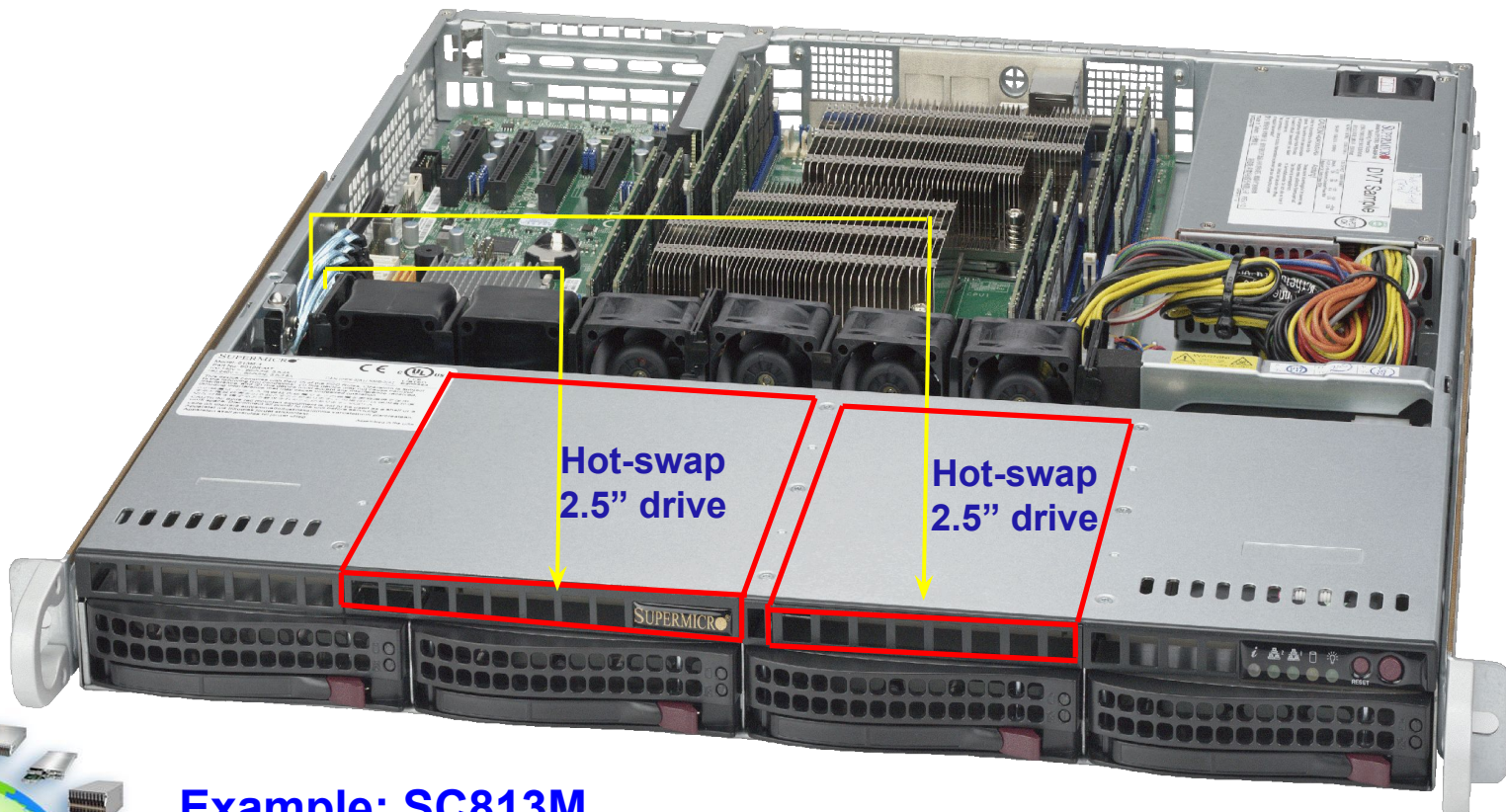

Example: SC813M



NVMe

SSD

HDD

Корзины с горячей заменой

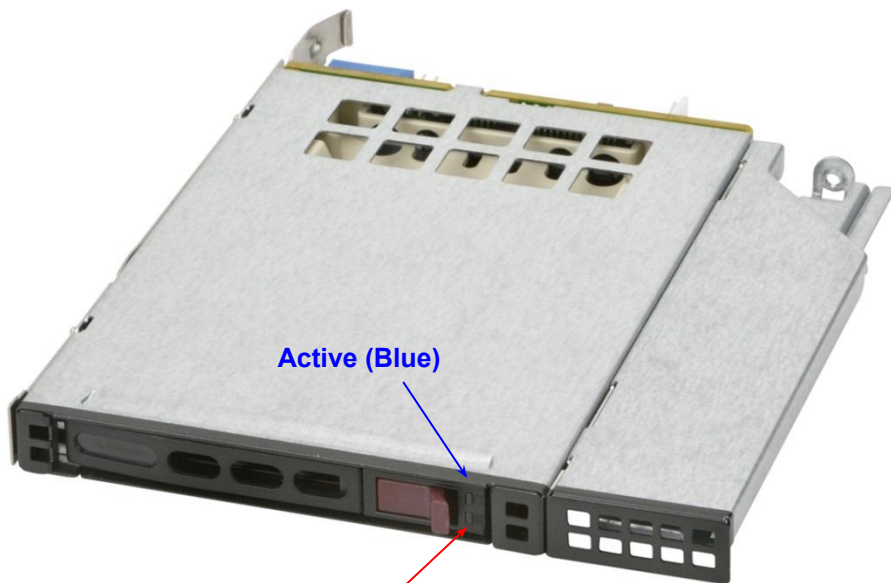

Active (Blue)

Status
(Red)

Slim DVD Size
(MCP-220-81506-0N)

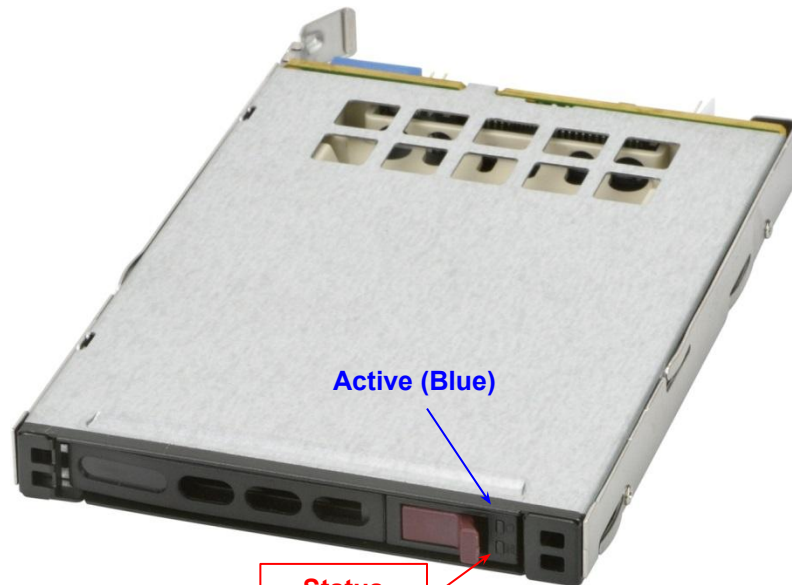

Active (Blue)

Status
(Red)

Slim Floppy Size
(MCP-220-81504-0N)





NVMe становится доступнее

Rear NVMe x2 (MCP-220-82617-0N)
=Backplane Board: **BPN-NVMe3-826N-B2B**

NEW



1	Dimensions 3.2"x 1.6"x 6.1" (81x41x155mm)
2	Gross Weight 1.5 lbs (0.68 kg)
3	Available Color Black
4	Occupancy 1x Rear 2.5"x2 Drive Bay
5	Capacity 2x 2.5" Hot-swap NVMe Drives
6	Configuration Direct attached via OCUlink cables (PN TBD)
7	System Monitoring Support Drive Activity/Failure LED
8	Cooling N/A (use chassis fan)
9	Cable TBD

Key Features

- Support 2.5" NVMe Drives x2
- Point-to-point direct attached backplane supports NVMe
- LED indicators for monitoring drive activity, rebuild or failure
- **Reference MB configurations only for X10**; all supported for X11.

Compatible Chassis

- SC216B, SC826B, SC826S, SC846X, SC847B, SC226S, SC417B
- SC836B, SC835B (use MCP-220-82618-0N)



NVMe
SSD
HDD



SYS-1028U-TN20R25M+

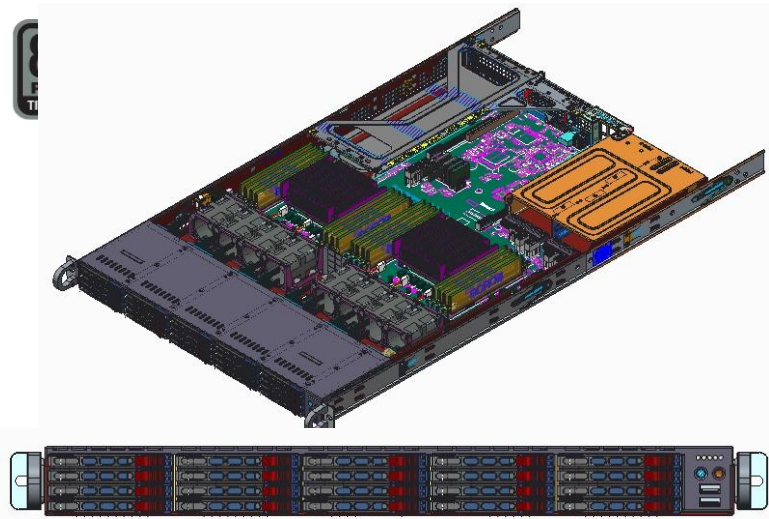

1	Processor Support Intel® Xeon® processor E5-2600 v4/v3 family
2	Memory Capacity 24 DIMM, DDR4 up to 3TB ECC 3DS LRDIMM, 768GB ECC RDIMM up to 2400MHz
3	Expansion Slots 1 PCI-E Gen 3.0 x16 (LP Internal) 1 PCI-E Gen 3.0 x8 (LP)
4	I/O ports Two 25G SFP28 Ethernet ports 2 VGA ports (1 rear, 1 onboard) 1 COM/Serial port (rear) 5 USB 3.0 ports (2 rear, 2 front, 1 Type A)
5	System management Built-in Server management tool (IPMI 2.0, KVM/media over LAN) with dedicated LAN port
6	Drive Bays 20 hot-swap 2.5" 7mm drive bays 20 NVMe ports (From CPU2 via 2x PCI-E switches)
7	System Cooling 8 heavy duty fans w/ Optimal Fan Speed Control; 1 Air Shroud
8	Power Supply Two 1200W High-efficiency (Titanium level) digital power supply

KEY FEATURES

- **20 hot-swap 2.5" NVMe drives support**
- **24 DIMM, 3TB ECC 3DS LRDIMM up to 2400MHz**
- **Up to 2 PCI-E 3.0 Add-on cards**
- **Optimized cooling (145W CPUs)**
- **2 25G SFP28 Ethernet ports**
- **Redundant Titanium level high efficiency digital power supply**
- **2 SATA ports with built-in SATA DOM power Support**



NVMe
SSD
HDD



Intel 200W Processors Support

- **New Intel 200W Processor**
 - ◆ High Cores: 20
 - ◆ Higher Frequency: 2.5GHz (3.2 GHz OC)
 - ◆ Better Cost
 - ◆ Consider if your customer are using
 - E5-2698 v4: 20 core, 2.2GHz, 135W
 - E5-2699 v4: 22 core, 2.2GHz, 145W
- **Ultra Series Supports 200W CPU!**
 - ◆ Optimized Design
 - ◆ Side by Side CPUs
 - ◆ Parallel Airflow
 - ◆ Quality Components
 - ◆ Optional: 1600W PSU

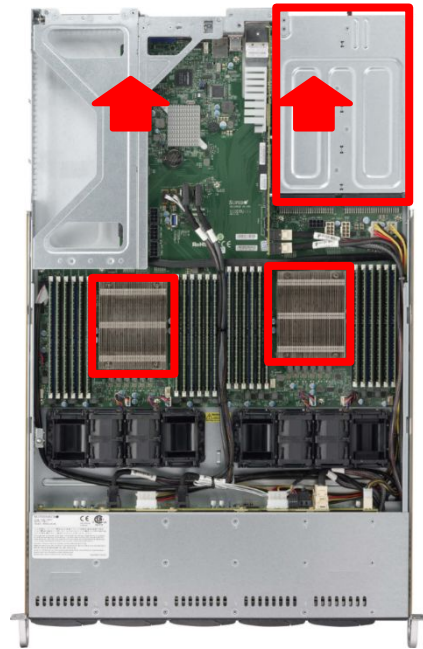

NVMe

SSD

HDD



NVMe

SSD

HDD



Сотрудники

Телефон

Email

Евгений Борисов (FAE)

(495) 648-5181

evgeniyb@supermicro.com

Сергей Сенько (Sr. Sales Manager)

(495) 648-5161

sergeys@supermicro.com

Юрий Горохов (Account manager)

(495) 648-5101

yuriyg@supermicro.com



Disclaimer

Super Micro Computer, Inc. may make changes to specifications and product descriptions at any time, without notice. The information presented in this document is for informational purposes only and may contain technical inaccuracies, omissions and typographical errors. Any performance tests and ratings are measured using systems that reflect the approximate performance of Super Micro Computer, Inc. products as measured by those tests. Any differences in software or hardware configuration may affect actual performance, and Super Micro Computer, Inc. does not control the design or implementation of third party benchmarks or websites referenced in this document. The information contained herein is subject to change and may be rendered inaccurate for many reasons, including but not limited to any changes in product and/or roadmap, component and hardware revision changes, new model and/or product releases, software changes, firmware changes, or the like. Super Micro Computer, Inc. assumes no obligation to update or otherwise correct or revise this information.

SUPER MICRO COMPUTER, INC. MAKES NO REPRESENTATIONS OR WARRANTIES WITH RESPECT TO THE CONTENTS HEREOF AND ASSUMES NO RESPONSIBILITY FOR ANY INACCURACIES, ERRORS OR OMISSIONS THAT MAY APPEAR IN THIS INFORMATION.

SUPER MICRO COMPUTER, INC. SPECIFICALLY DISCLAIMS ANY IMPLIED WARRANTIES OF MERCHANTABILITY OR FITNESS FOR ANY PARTICULAR PURPOSE. IN NO EVENT WILL SUPER MICRO COMPUTER, INC. BE LIABLE TO ANY PERSON FOR ANY DIRECT, INDIRECT, SPECIAL OR OTHER CONSEQUENTIAL DAMAGES ARISING FROM THE USE OF ANY INFORMATION CONTAINED HEREIN, EVEN IF SUPER MICRO COMPUTER, Inc. IS EXPRESSLY ADVISED OF THE POSSIBILITY OF SUCH DAMAGES.

ATTRIBUTION

© 2017 Super Micro Computer, Inc. All rights reserved.





NVMe

SSD

HDD