

Силуэт судна



Рис. 1. Силуэты бокового вида транспортных судов:
а - универсальное сухогрузное судно, б - танкер



Силуэты танкеров



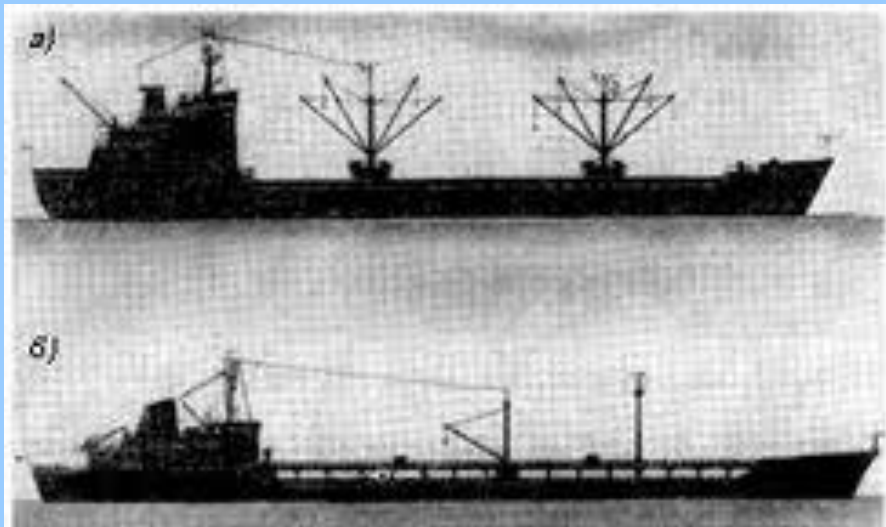
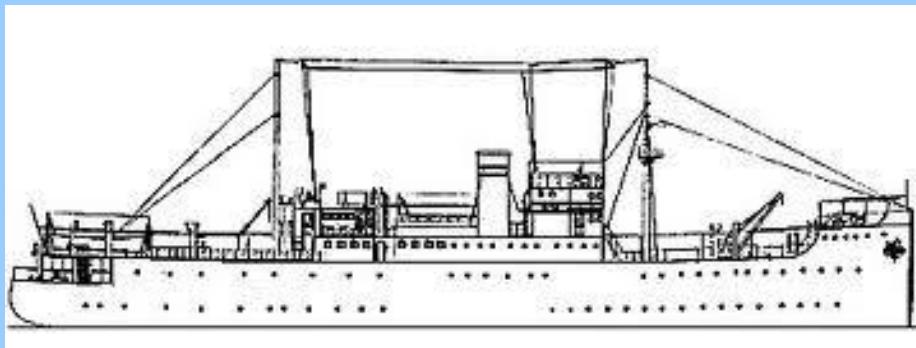
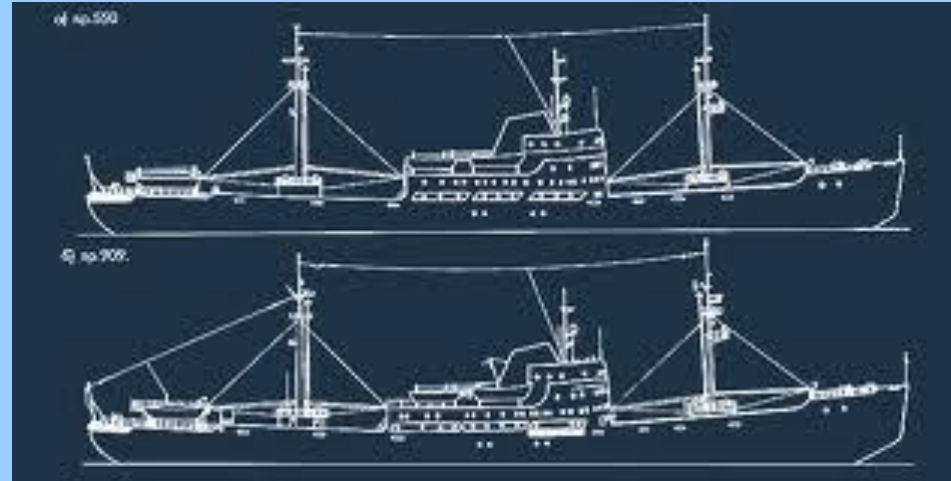
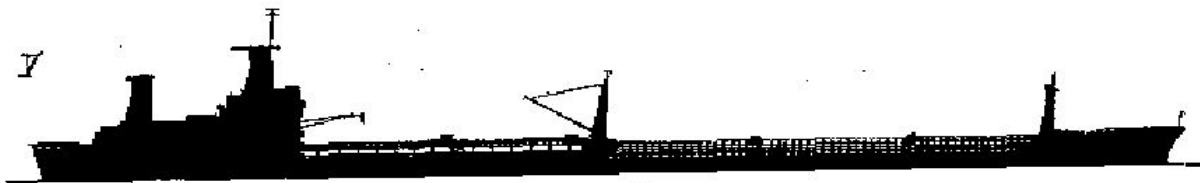
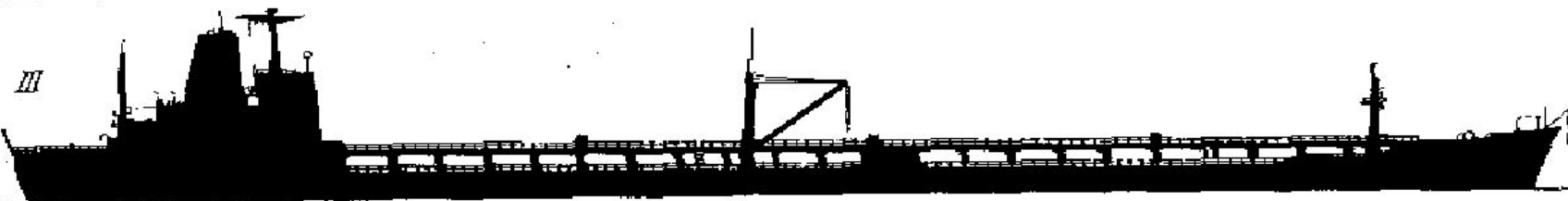
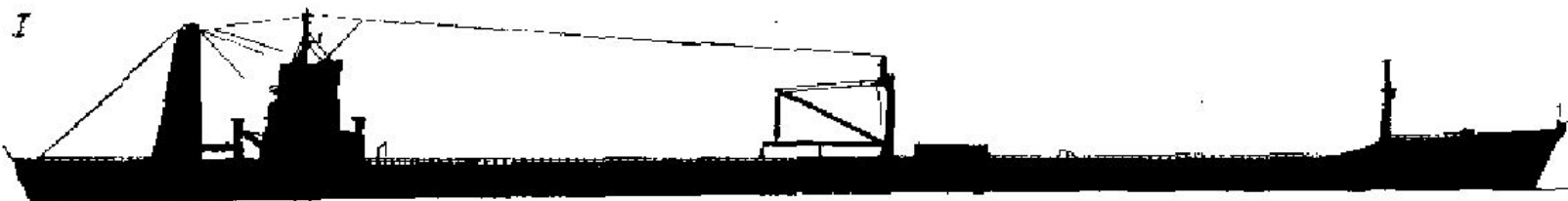
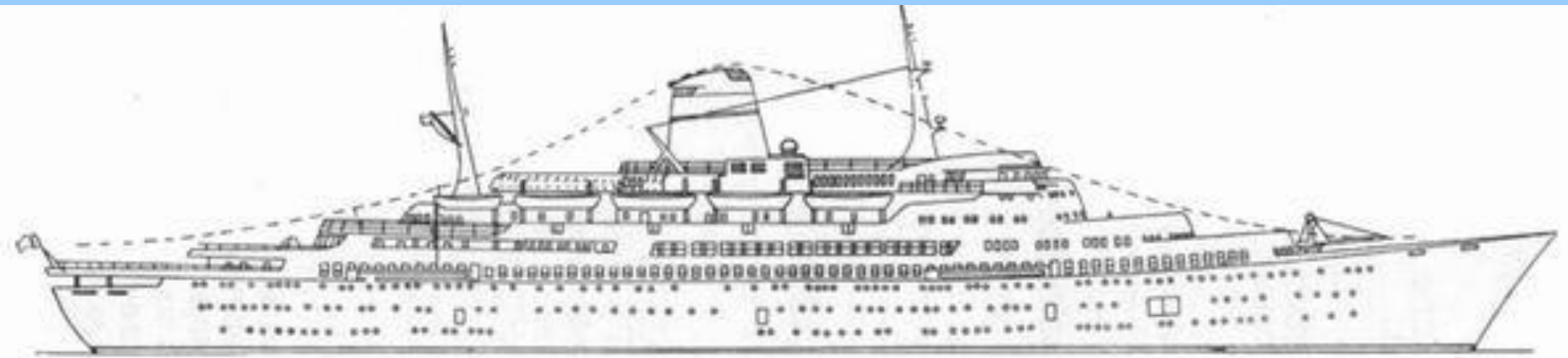

б)

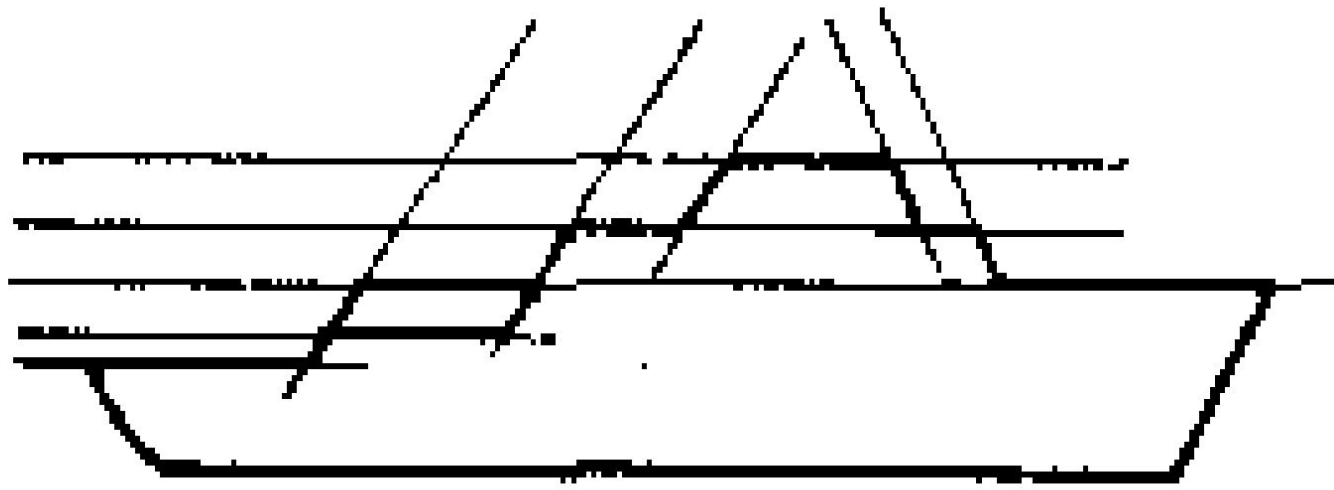

б)

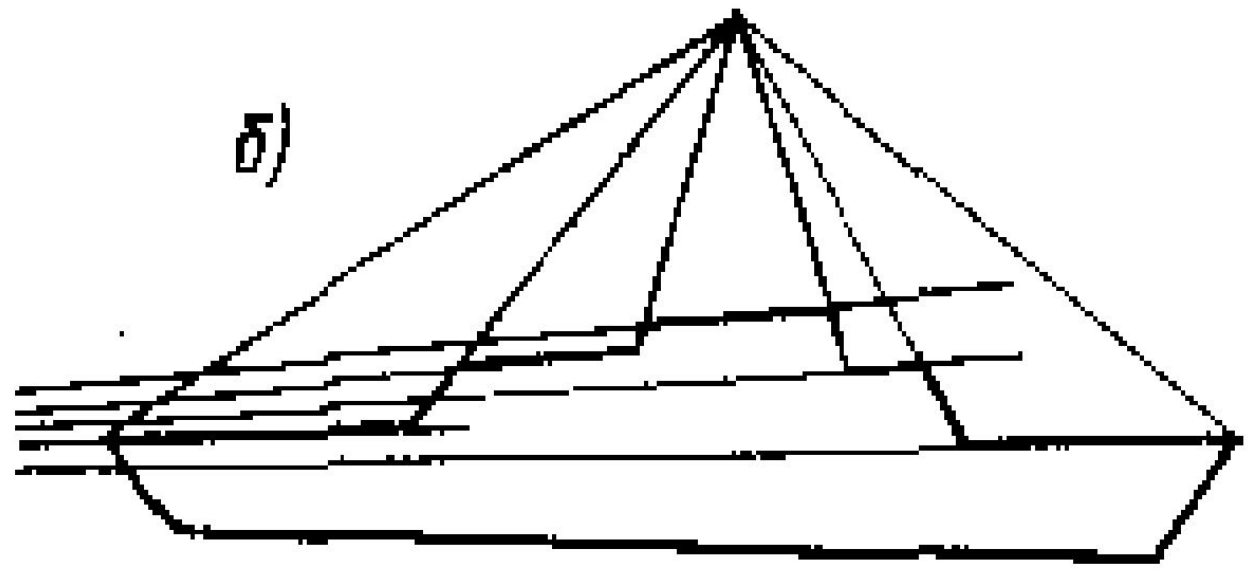

Седловатость



Рис. 6.4. Построение стандартного (а) и нестандартного (б) профилей седловатости палубы судна

Контуры силуэта в оконечностях и у средней надстройки

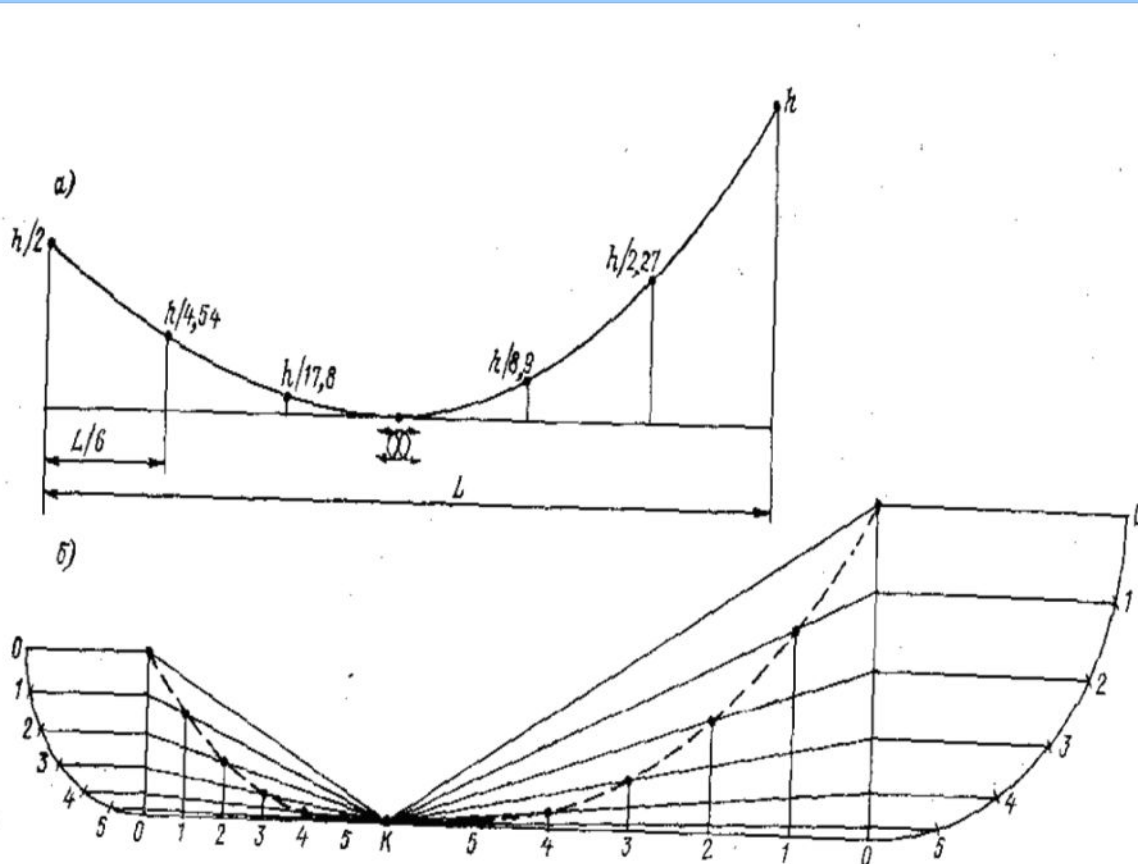

Рис. 6.5. Характерные контуры силуэта судов в носовой оконечности (а—з, м), у средней надстройки (и—л) и у юта (н—с)

Форма носовой и кормовой оконечностей



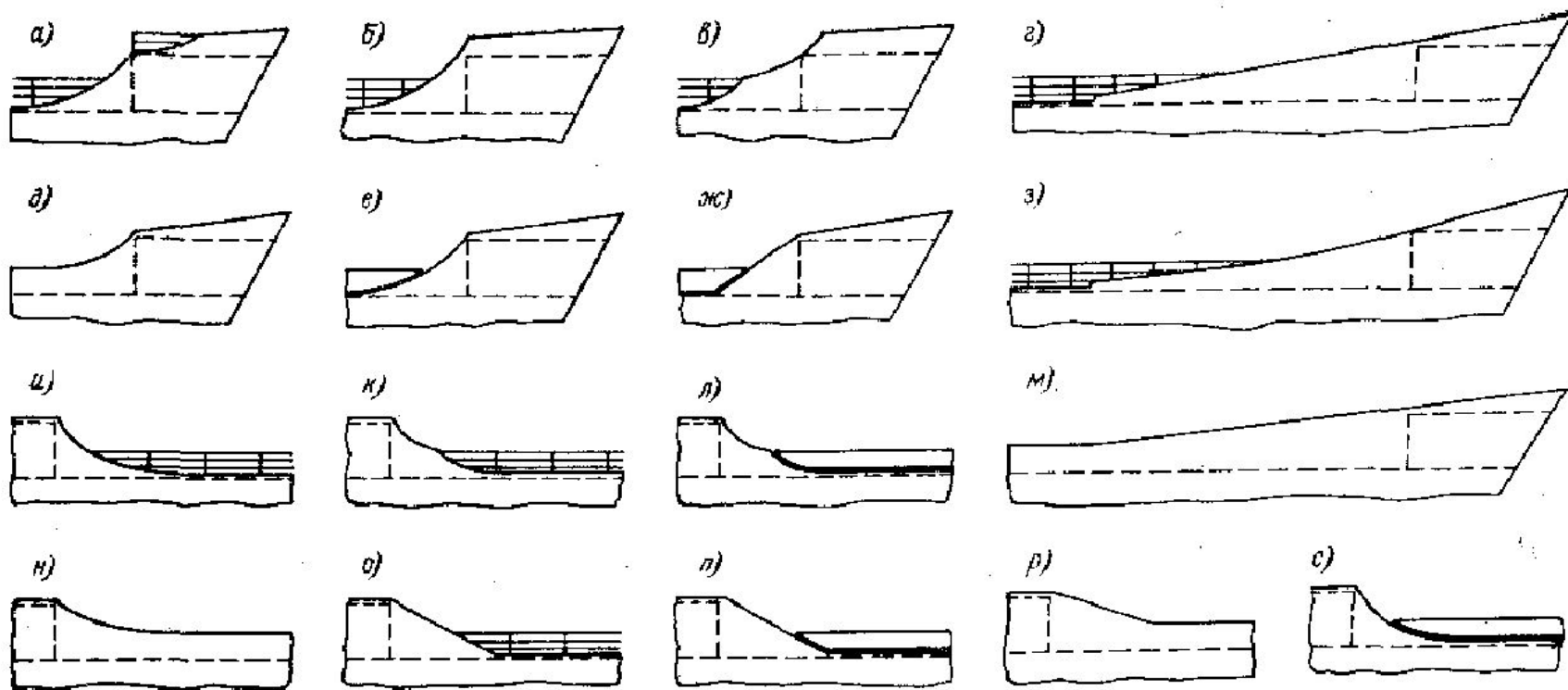
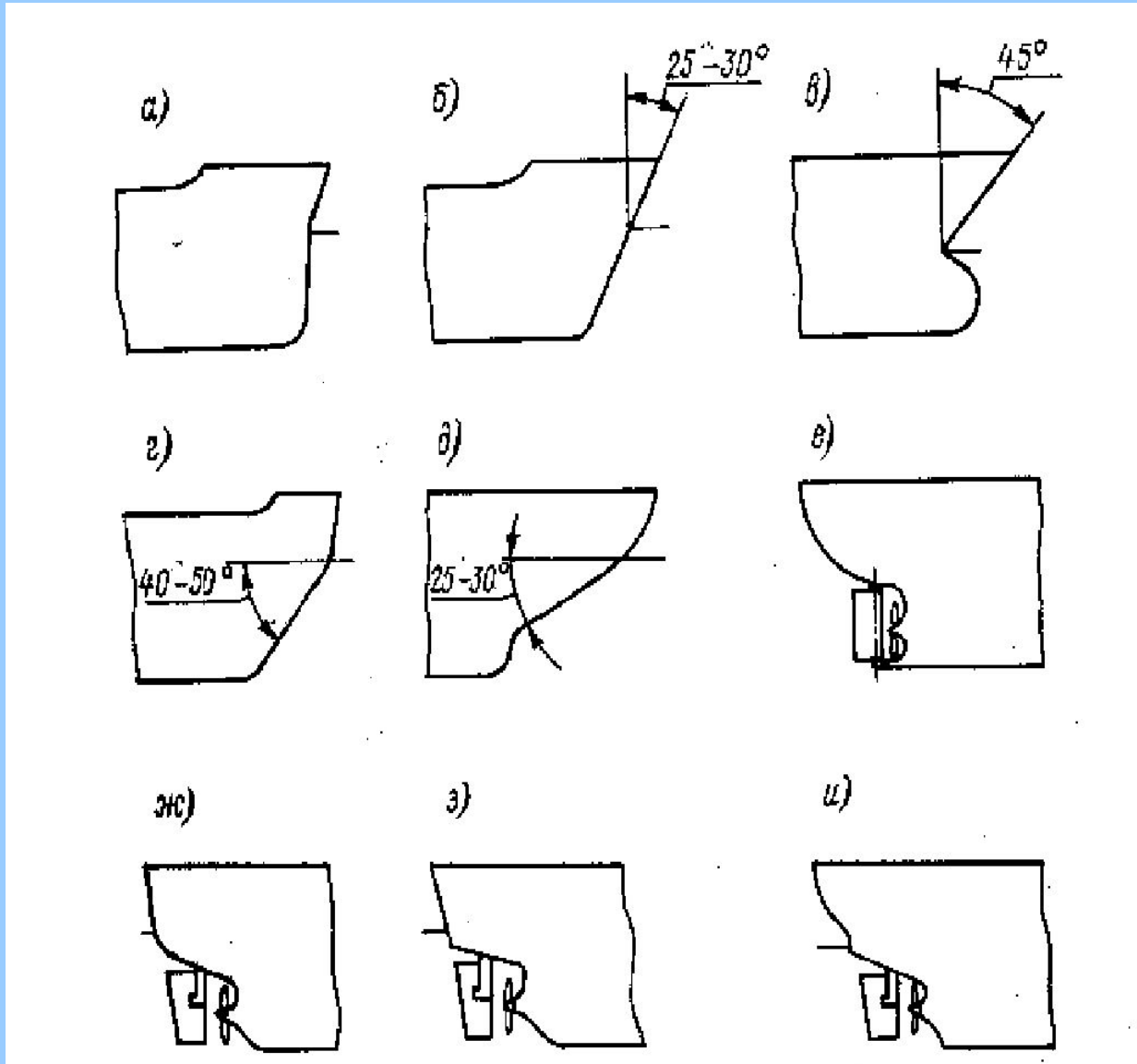
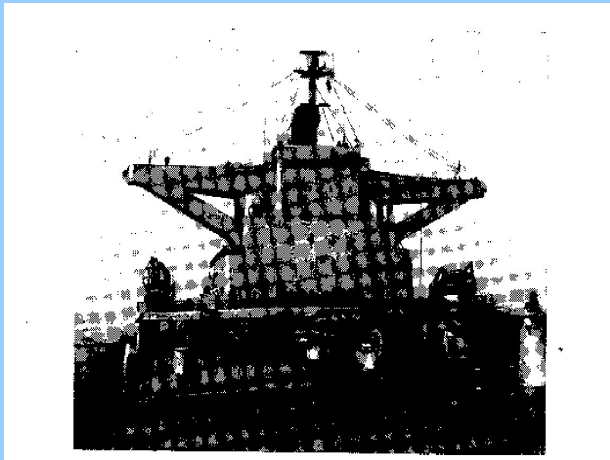

Суда накатные



Рис.45. Схемы СУГ с различными вариантами расположения и конструкции надстройки



Кормовая надстройка «Академик Туполев»

Кормовые надстройки танкеров

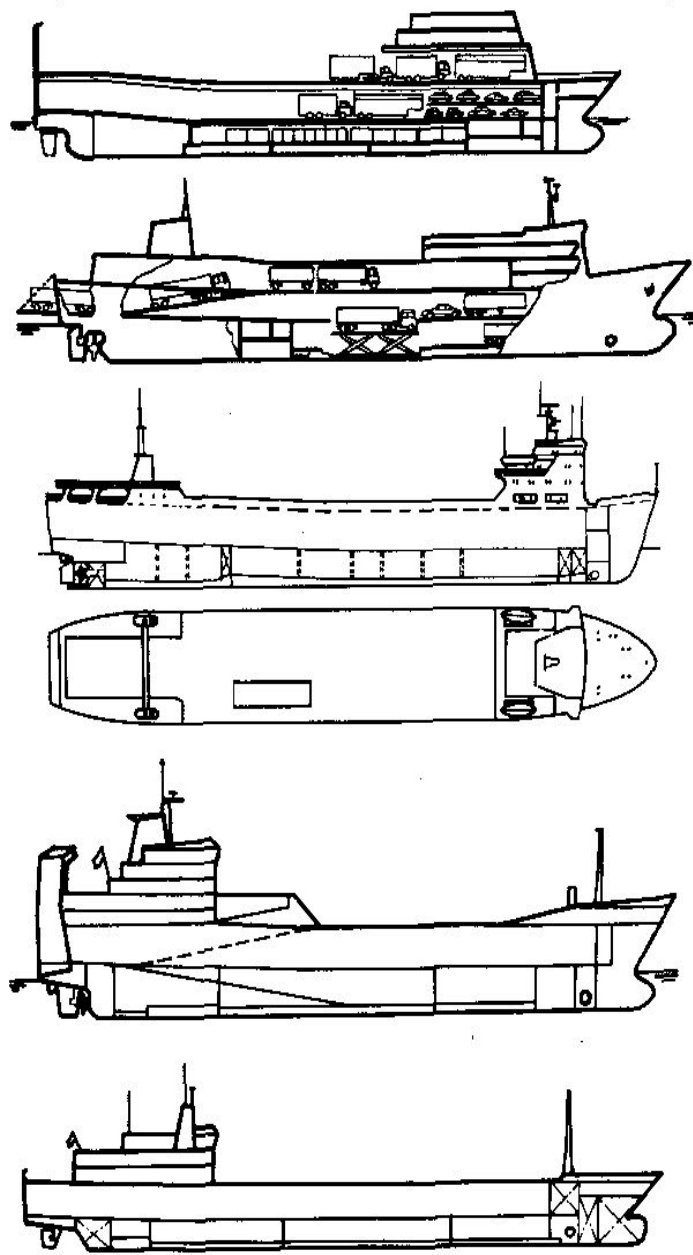
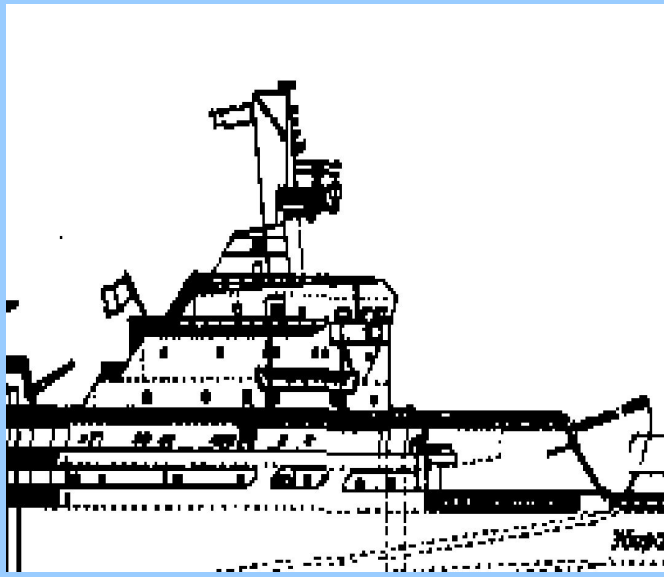
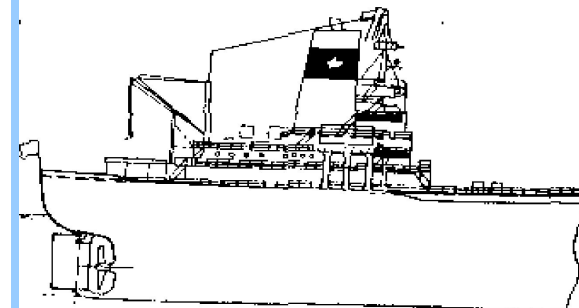
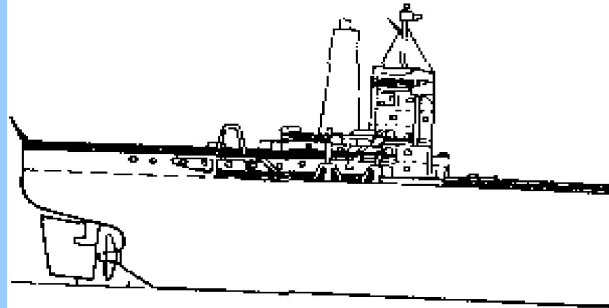
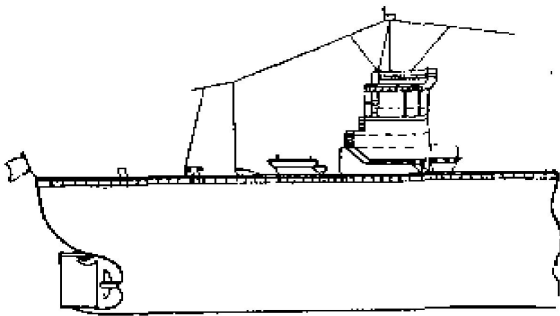
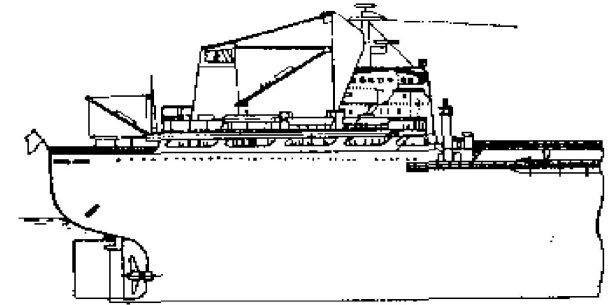
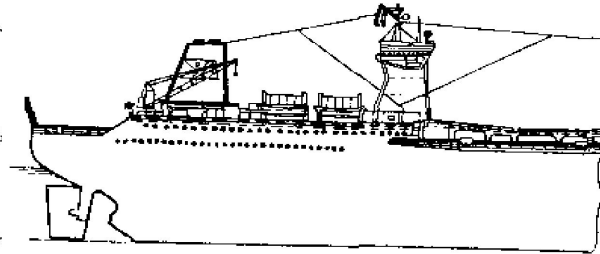
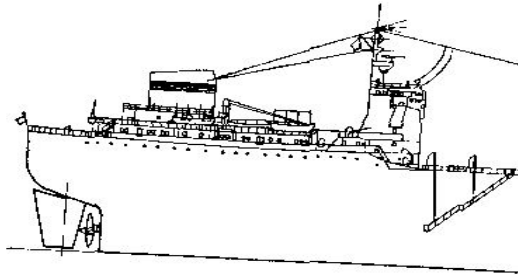

1 – Carlo Cameli

2 – Borgsten

3 – Bergebüg

4 – Yamaju Maru

5 – Esso Houston

6 – Petros J. Goulandris

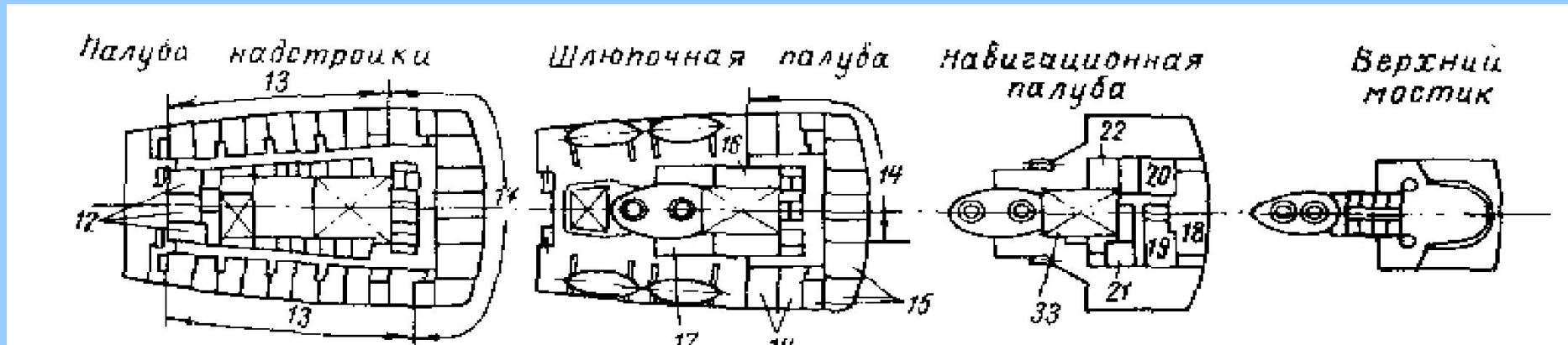

Палубы надстройки танкера «Сплит»

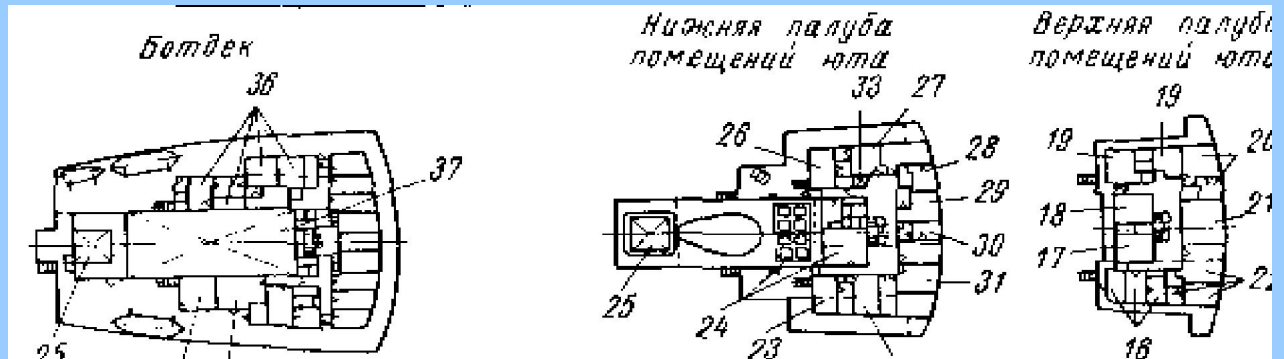
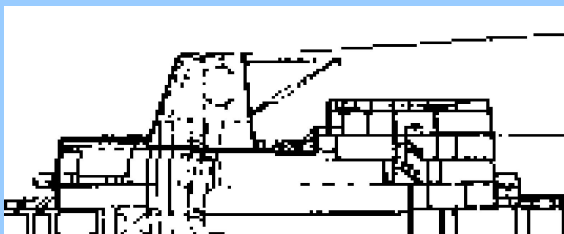

a)

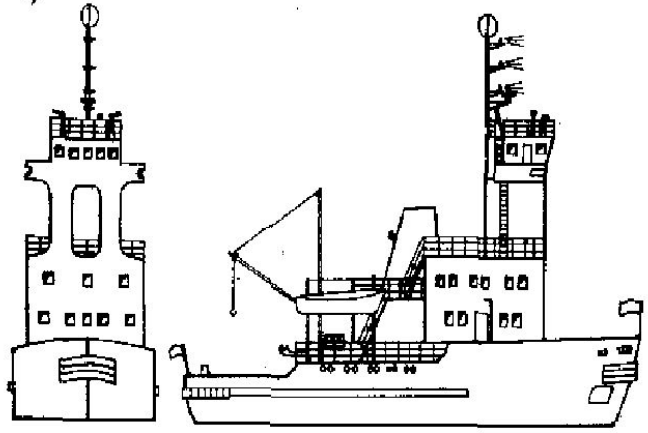

b)

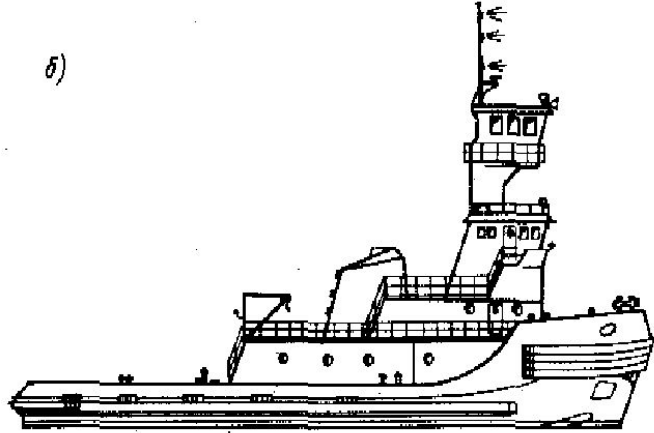

c)

