

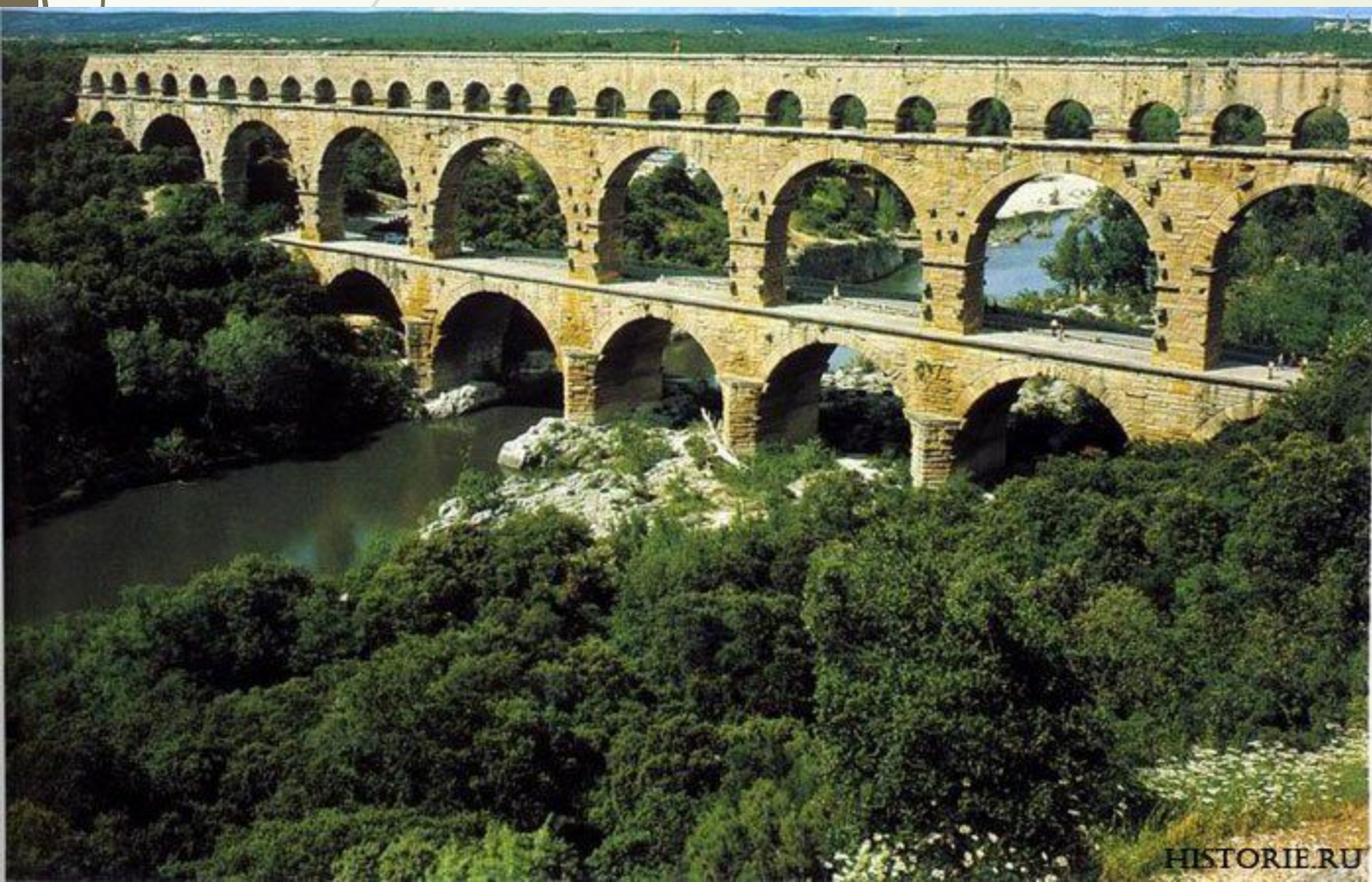

Архитектура Византии





Х-ХІ вв. крестово-купольные храмы

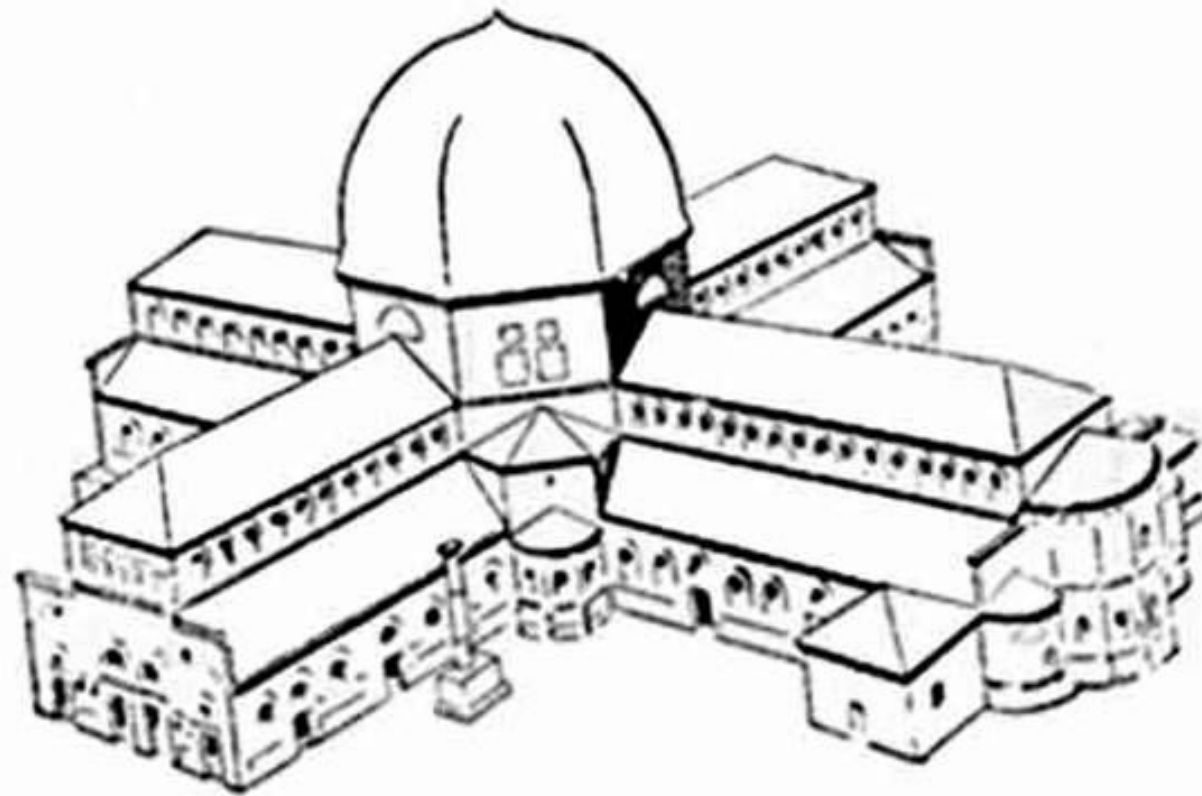
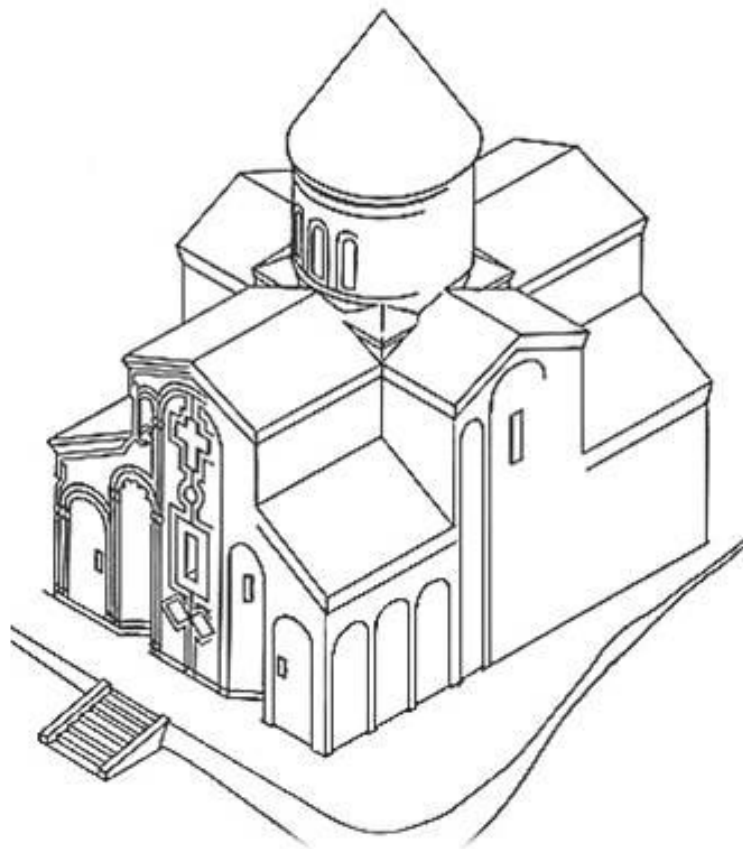

Купольная базилика





a)



б)



в)



г)

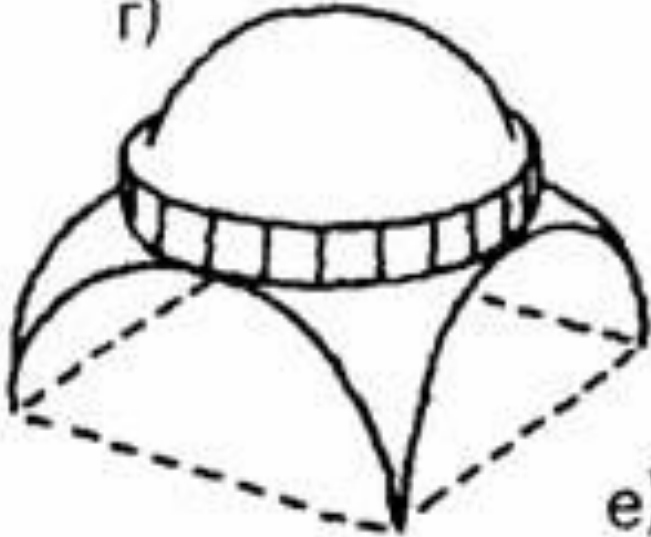

д)

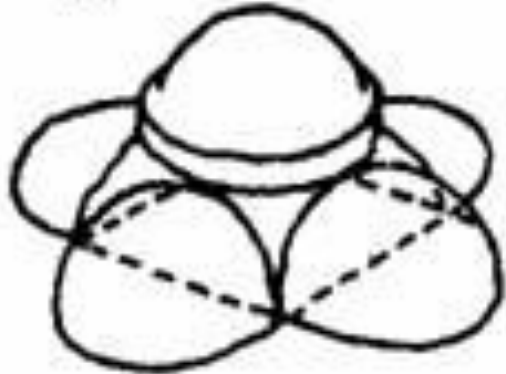

е)

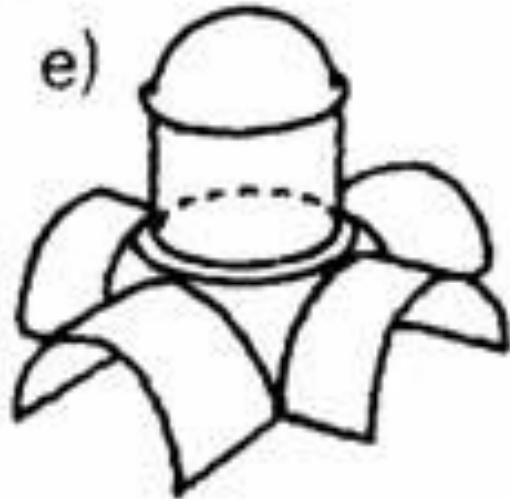

Тромпы

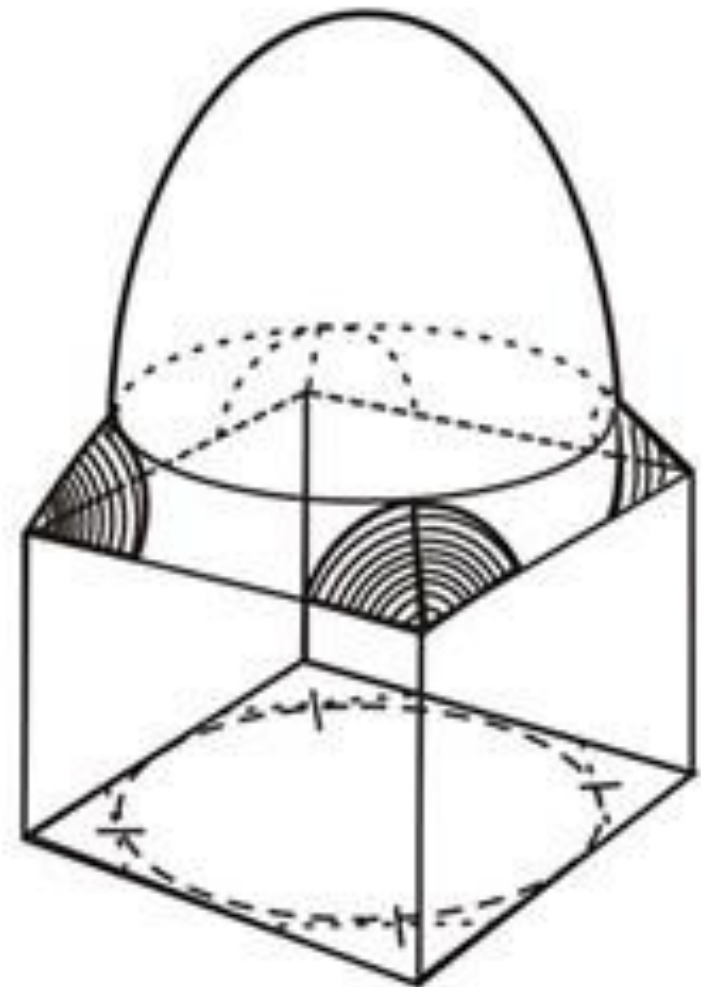

© ООО «Старик и Мефодей»

**Собор
святой
Софии в
Константи
нополе
(527 г.)**



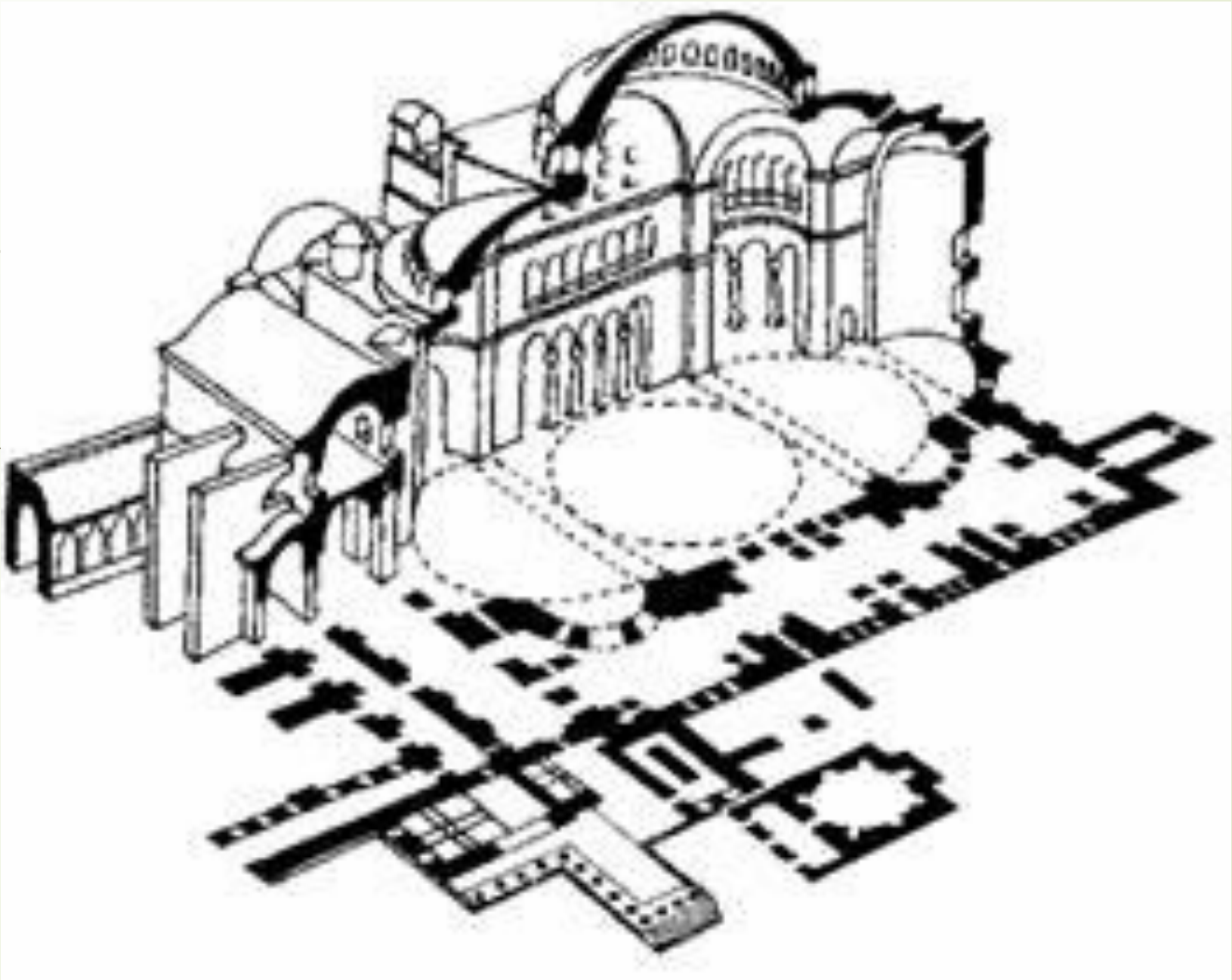



Церковь Святой Ирины в Константинополе (IV век)



The existing square-headed Turkish windows are shown within the original semicircular-headed openings. The pedestals below the columns of nave arcade are at present cased in wood; one of these was uncovered, and was found to be a roughly-squared stone block; there is evidence that two others are similar.

S. IRENE LONGITUDINAL SECTION

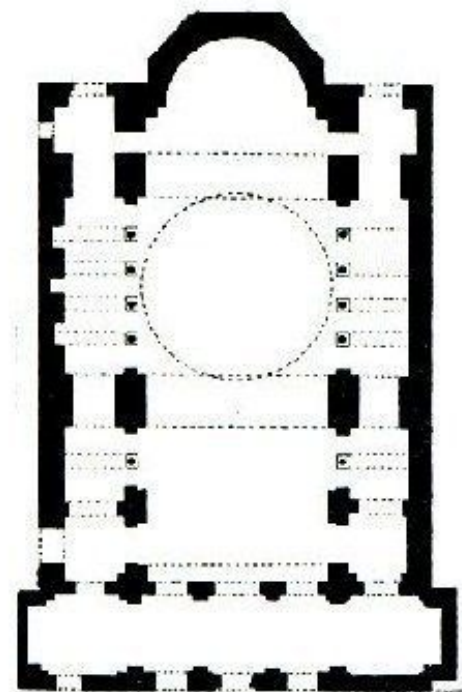
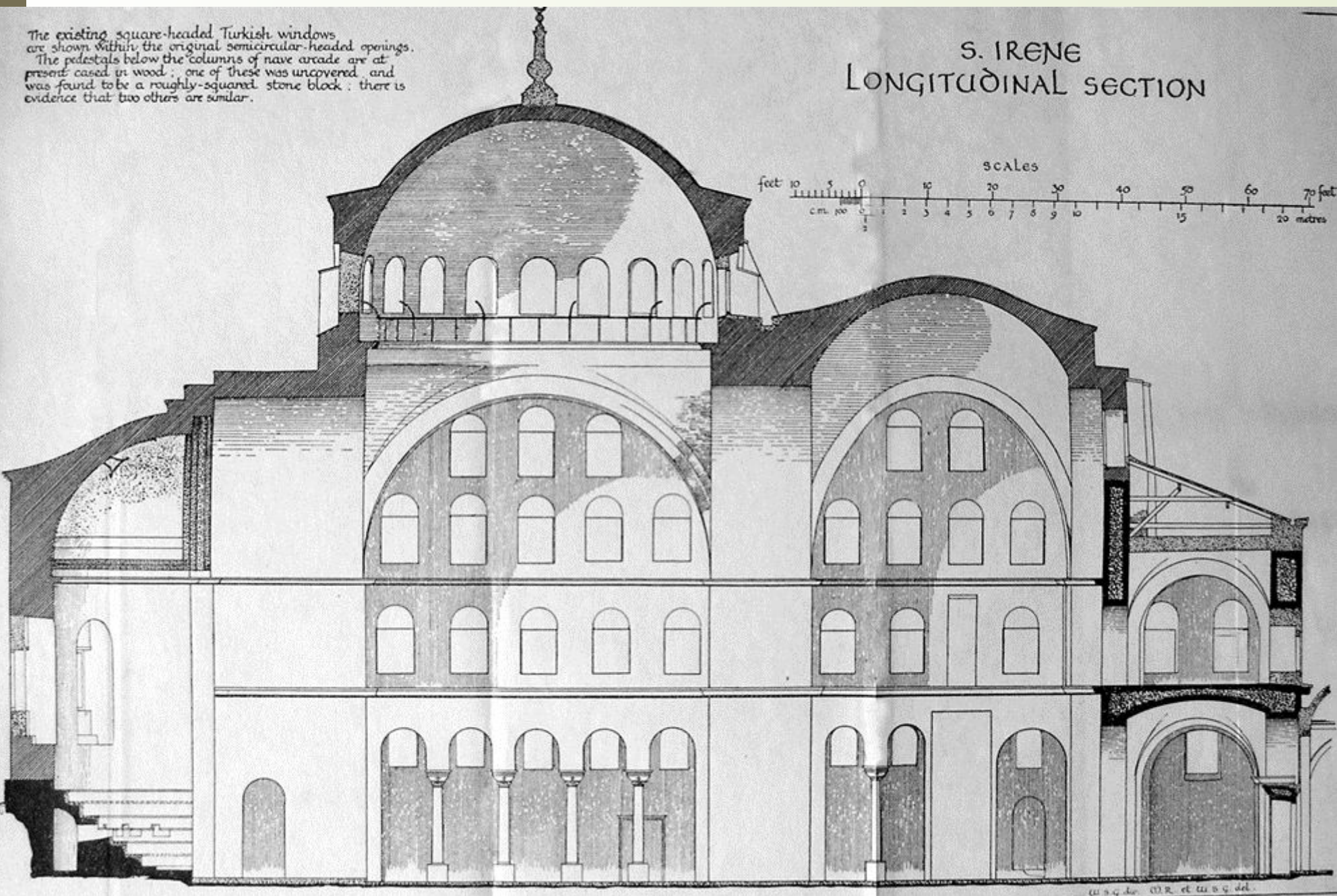
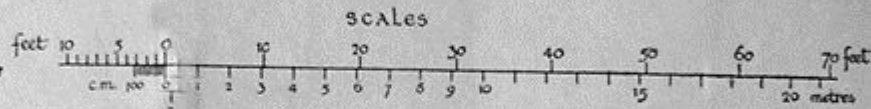

Церковь св. Ирины
в Константинополе.

Аркады на колоннах

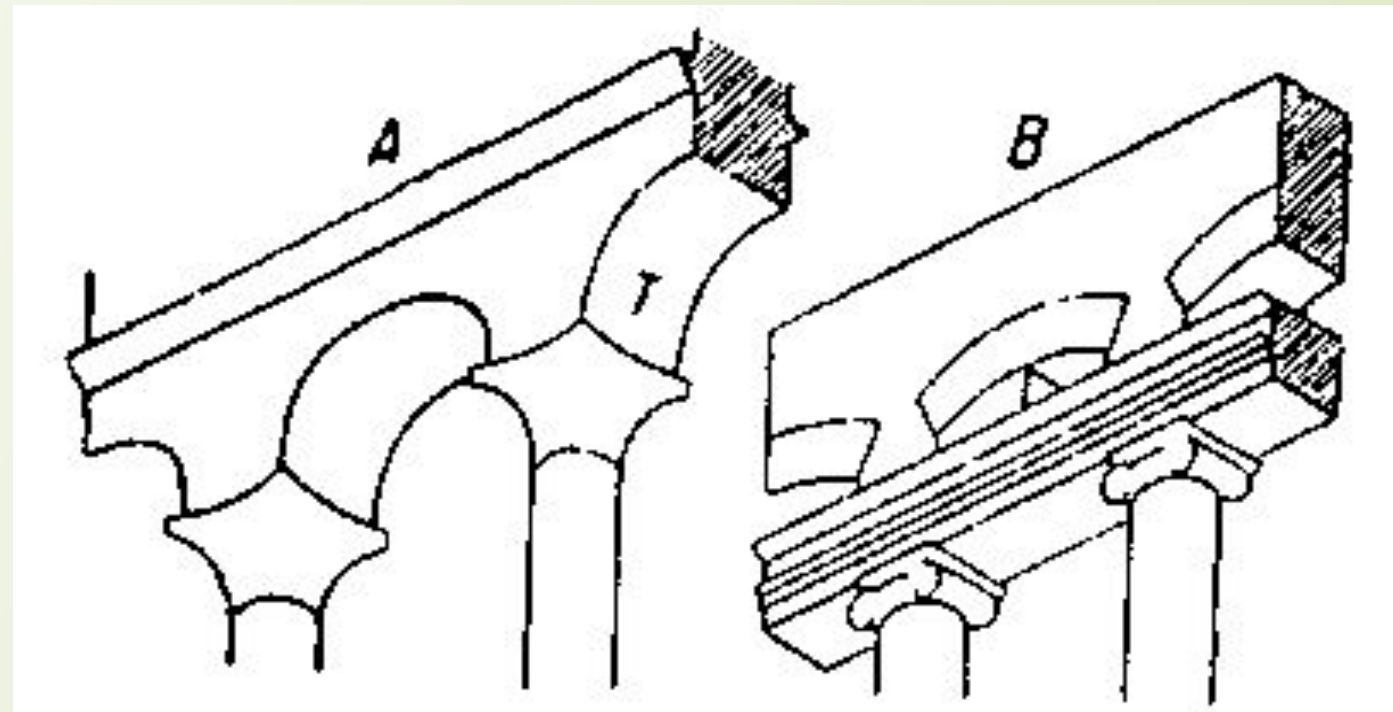

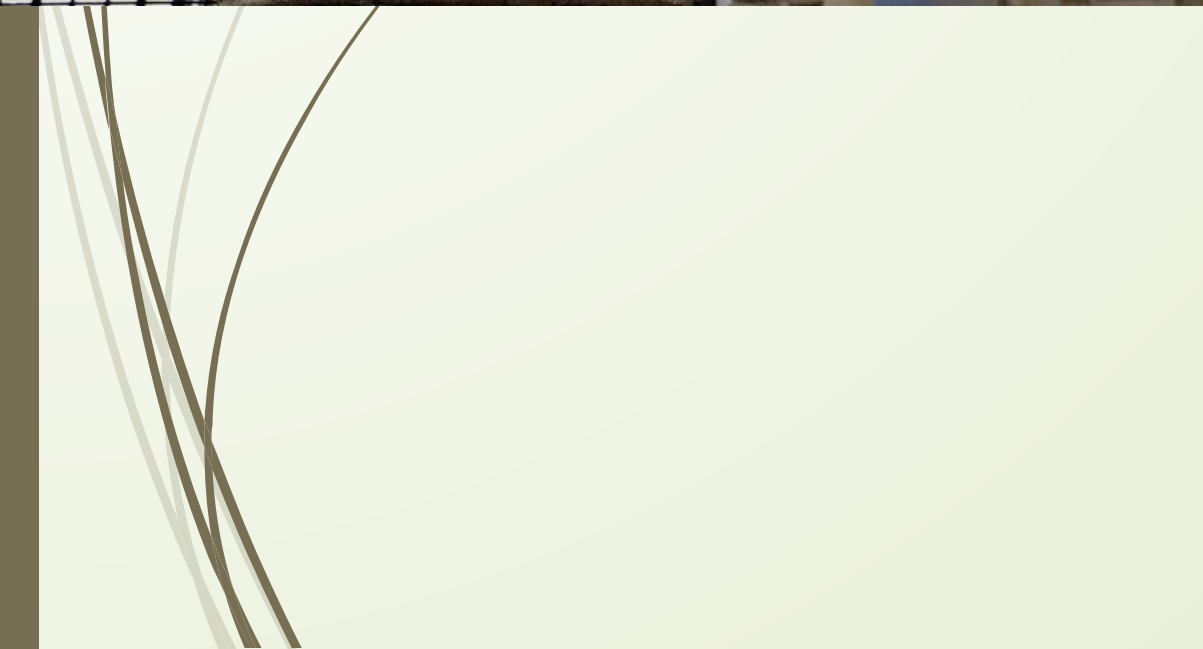

Плинфа





Церковь эпохи Византии на Кипре

Византийская церковь Panagia



